

2026 • 2027

ctesi

É UMA CASA DE BANHO
PORTUGUESA, COM CERTEZA!

ctesi

Criamos espaços. Inspiramos experiências.

Acreditamos que a casa de banho é mais do que um espaço funcional — é um lugar de conforto, identidade e bem-estar.

Na CTESI, unimos design, inovação e mestria industrial para transformar ideias em ambientes únicos.

Cada móvel, cada torneira, cada detalhe nasce de um compromisso com a qualidade, a personalização e a excelência.

Porque cada projeto tem uma visão. E cada visão merece ganhar forma.

Com a solidez industrial do Grupo B&M, damos vida a soluções que elevam o espaço de banho a uma nova expressão de estilo e sofisticação.

Nous créons des espaces. Nous inspirons des expériences.

Nous croyons que la salle de bain est plus qu'un espace fonctionnel — c'est un lieu de confort, d'identité et de bien-être. Chez CTESI, nous unissons design, innovation et maîtrise industrielle pour transformer les idées en environnements uniques.

Chaque meuble, chaque robinet, chaque détail naît d'un engagement envers la qualité, la personnalisation et l'excellence. Parce que chaque projet a une vision. Et chaque vision mérite de prendre forme.

Avec la solidité industrielle du Groupe B&M, nous donnons vie à des solutions qui élèvent l'espace de bain vers une nouvelle expression de style et de sophistication.

We create spaces. We shape experiences.

The bathroom is more than a functional setting — it is a sanctuary of comfort, identity, and well-being. At CTESI, we transform this vision into reality by uniting refined design, continuous innovation, and true industrial mastery.

Every piece, every faucet, every detail reflects our dedication to quality, customization, and uncompromising excellence. Because behind every project there is a vision — and every vision deserves to be brought to life with precision and purpose.

Supported by the industrial strength of the B&M Group, we craft solutions that elevate the bathroom into a distinctive statement of style, sophistication, and enduring value.

Creemos espacios. Inspiramos experiencias.

Creemos que el baño trasciende su función — es un refugio de bienestar, identidad y armonía. En CTESI, fusionamos diseño, innovación y excelencia industrial para transformar cada idea en un entorno exclusivo.

Cada mueble, cada grifo, cada detalle nace de una dedicación absoluta a la calidad, la personalización y la perfección. Porque cada proyecto encierra una visión. Y toda visión merece materializarse con distinción.

Respaldados por la solidez industrial del Grupo B&M, damos forma a soluciones que elevan el espacio de baño a su máxima expresión de estilo, sofisticación y carácter.

DESENHADO E FABRICADO EM
PORTUGAL

Índice geral

general index
index général
Índice general

04 O Grupo B&M



10 Móveis de banho

Bathroom furniture
Meubles de salle de bains
Muebles de baño



122 Espelhos

Mirrors
Miroirs
Espejos



130 Torneiras

Taps
Robinets
Grifos



178 Acessórios de banho

Bathroom accessories
Accessoires de salle de bain
Accesorios de baño

240

Bases de duche e banheiras

Showers trays and bathtubs
Receveurs de douche et baignoires
Platos de ducha y bañeras



272

Coleções sanitárias

Sanitary collections
Collections sanitaires
Colecciones sanitarias



186

Divisórias

Showers partitions
Cloisons de douche
Mamparas de ducha



252

Sistemas de instalação

Installations systems
Systèmes d'installation
Sistemas de instalación



286

Espaços públicos

Public spaces
Espaces publics
Espacios públicos

Grupo B&M

DESENHADO E FABRICADO EM
PORTUGAL

A força por trás da marca CTESI

O Grupo B&M é um dos principais grupos industriais portugueses, dedicado ao desenvolvimento e produção de soluções integradas para espaços de banho. Com cinco fábricas que trabalham de forma complementar, assegura qualidade, capacidade produtiva e flexibilidade para responder tanto à produção em série como a projetos personalizados.

La force derrière la marque CTESI

El Grupo B&M es uno de los principales grupos industriales portugueses, dedicado al desarrollo y producción de soluciones integradas para espacios de baño. Con cinco fábricas que trabajan de manera complementaria, garantiza calidad, capacidad productiva y flexibilidad para responder tanto a la producción en serie como a proyectos personalizados.

The strength behind the CTESI brand

Le Groupe B&M est l'un des principaux groupes industriels portugais, dédié au développement et à la production de solutions intégrées pour les espaces de bain. Avec cinq usines fonctionnant de manière complémentaire, il garantit qualité, capacité de production et flexibilité pour répondre aussi bien à la production en série qu'aux projets personnalisés.

La fuerza detrás de la marca CTESI

The B&M Group is one of the leading Portuguese industrial groups, dedicated to the development and production of integrated solutions for bathroom spaces. With five factories operating in a complementary way, it ensures quality, production capacity, and flexibility to meet both mass production demands and customized projects.

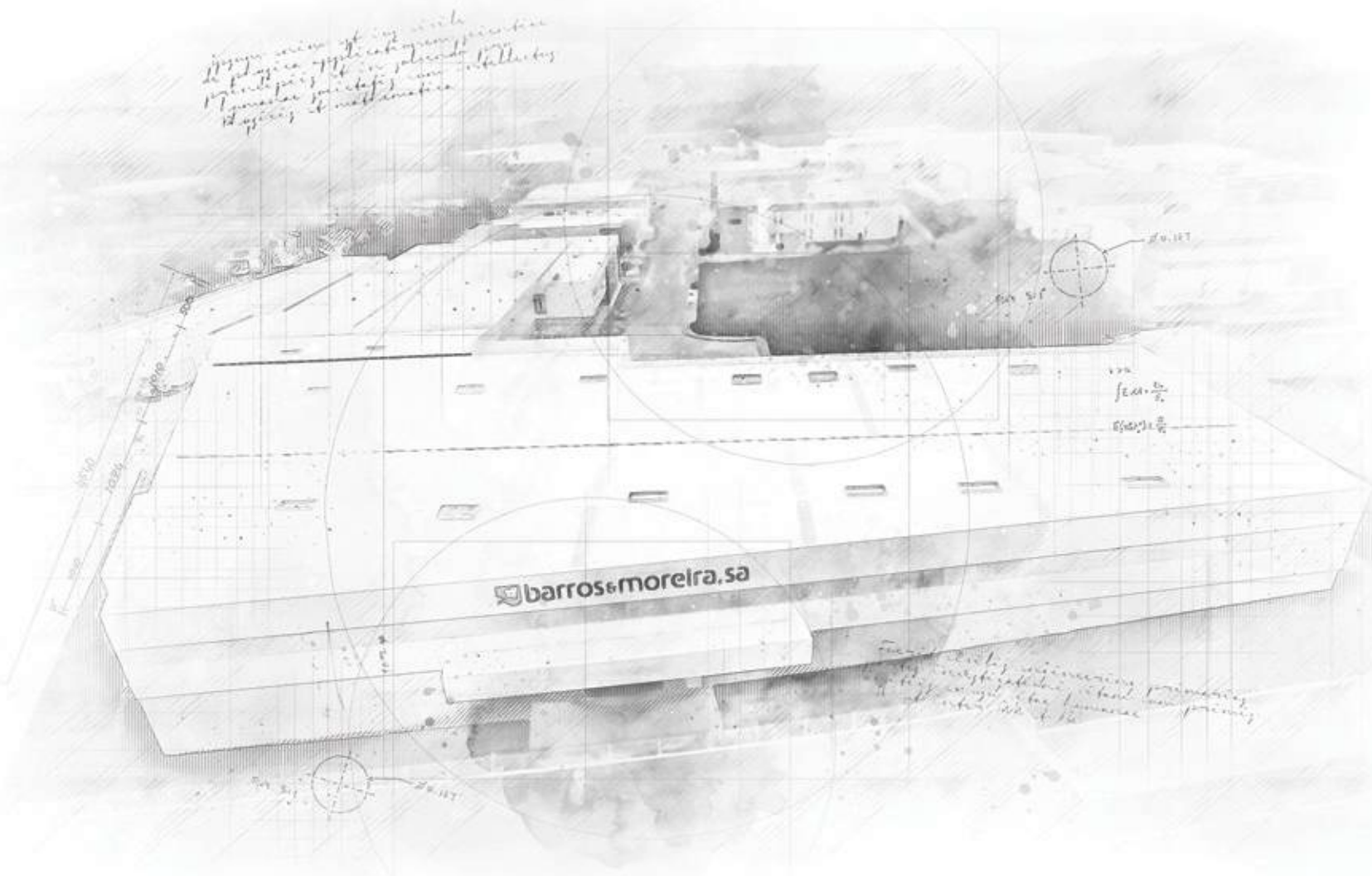

bmwood

INDÚSTRIA DE MOBILIÁRIO

Fábrica de mobiliário em madeira e derivados, que alia tecnologia moderna a um cuidado especial com o design e os acabamentos.

A factory specialized in wooden furniture and derivatives, combining modern technology with special attention to design and finishes.

Usine de fabrication de mobilier en bois et dérivés, alliant technologie moderne et une attention particulière au design et aux finitions.

Fábrica de mobiliario en madera y derivados, que combina tecnología moderna con especial atención al diseño y los acabados.

bmplast

INDÚSTRIA DE TERMOPLÁSTICOS

Fábrica especializada na produção de componentes sanitários em termoplástico, garantindo eficiência, fiabilidade e elevados padrões de qualidade.

A factory specialized in the production of thermoplastic sanitary components, ensuring efficiency, reliability, and high-quality standards.

Usine spécialisée dans la production de composants sanitaires en thermoplastique, garantissant efficacité, fiabilité de hauts standards de qualité.

Fábrica especializada en la producción de componentes sanitarios en termoplástico, garantizando eficiencia, fiabilidad y altos estándares de calidad.

bm solid

INDÚSTRIA DE SOLID SURFACE

Fábrica focada na produção de artigos em Solid Surface. A aposta contínua em I&D permitiu o desenvolvimento do CORIX, um material composto de nova geração que assegura resistência, durabilidade e qualidade.

A factory focused on the production of Solid Surface products. Continuous investment in R&D has led to the development of CORIX, a next-generation composite material that ensures strength, durability, and quality.

Usine spécialisée dans la production d'articles en Solid Surface. L'investissement continu en R&D a permis le développement du CORIX, un matériau composite de nouvelle génération garantissant résistance, durabilité et qualité.

Fábrica enfocada en la producción de artículos en Solid Surface. La apuesta continua por la I+D ha permitido el desarrollo de CORIX, un material compuesto de nueva generación que garantiza resistencia, durabilidad y calidad.

bmmetal

TORNEARIA DE PRECISÃO

Fábrica de metalomecânica de precisão para torneiras e componentes metálicos, combinando inovação, rigor e experiência.

A precision metalworking factory for faucets and metal components, combining innovation, expertise, and accuracy.

Usine de métallurgie de précision pour la robinetterie et composants métalliques, combinant innovation, rigueur et expertise.

Fábrica de mecanizado de precisión para grifería y componentes metálicos, combinando innovación, rigor y experiencia.

bmglass

INDÚSTRIA DE DIVISÓRIAS

Fábrica dedicada à produção de divisórias de duche e espelhos, com soluções versáteis e possibilidade de personalização.

A factory dedicated to the manufacturing of shower enclosures and mirrors, offering versatile solutions with customization options.

Usine dédiée à la fabrication de parois de douche et de miroirs, proposant des solutions polyvalentes avec possibilité de personnalisation.

Fábrica dedicada a la fabricación de mamparas de ducha y espejos, con soluciones versátiles y posibilidad de personalización.



ctesi

Soluções para o presente,
com responsabilidade
pelo futuro.



Soluções para o presente, com responsabilidade pelo futuro.

Na CTESI, a sustentabilidade é uma forma de pensar e agir que orienta toda a nossa atividade. Está presente na forma como desenvolvemos os nossos produtos, gerimos os recursos e construímos relações duradouras com clientes, parceiros e comunidades. Uma visão que nos permite criar valor hoje, com responsabilidade pelo futuro.

Inovar para preservar

Desenvolvemos soluções que promovem a poupança de água e energia através de tecnologias eficientes, sem comprometer o conforto, a funcionalidade ou a durabilidade.

Compromisso ambiental em toda a cadeia de valor

Promovemos uma gestão responsável dos recursos através da inovação, da eficiência energética e da melhoria contínua dos processos, reduzindo o impacto ambiental em cada etapa da nossa atividade.

Solutions for today, with responsibility for tomorrow.

At CTESI, sustainability is a way of thinking and acting that guides everything we do. It is reflected in how we develop our products, manage resources, and build lasting relationships with customers, partners and communities. A vision that enables us to create value today, with responsibility for the future.

Innovating to Preserve

We develop solutions that promote water and energy savings through efficient technologies, without compromising comfort, functionality or durability.

Environmental Commitment Throughout the Value Chain

We promote responsible resource management through innovation, energy efficiency and continuous process improvement, reducing environmental impact at every stage of our operations.

Des solutions pour aujourd'hui, pensées pour demain.

Chez CTESI, la durabilité est une manière de penser et d'agir qui guide l'ensemble de nos activités. Elle se reflète dans la façon dont nous concevons nos produits, gérons nos ressources et construisons des relations durables avec nos clients, partenaires et communautés. Une vision qui nous permet de créer de la valeur aujourd'hui, avec responsabilité pour l'avenir.

Innover pour préserver

Nous développons des solutions favorisant les économies d'eau et d'énergie grâce à des technologies performantes, sans compromettre le confort, la fonctionnalité ou la durabilité.

Engagement environnemental tout au long de la chaîne de valeur

Nous encourageons une gestion responsable des ressources grâce à l'innovation, à l'efficacité énergétique et à l'amélioration continue de nos processus, afin de réduire l'impact environnemental à chaque étape de notre activité.

Soluciones para hoy, con responsabilidad para el mañana.

En CTESI, la sostenibilidad es una forma de pensar y actuar que guía toda nuestra actividad. Está presente en la manera en que desarrollamos nuestros productos, gestionamos los recursos y construimos relaciones duraderas con clientes, socios y comunidades. Una visión que nos permite crear valor hoy, con responsabilidad hacia el futuro.

Innovar para preservar

Desarrollamos soluciones que promueven el ahorro de agua y energía mediante tecnologías eficientes, sin comprometer el confort, la funcionalidad ni la durabilidad.

Compromiso ambiental en toda la cadena de valor

Promovemos una gestión responsable de los recursos a través de la innovación, la eficiencia energética y la mejora continua de los procesos, reduciendo el impacto ambiental en cada etapa de nuestra actividad.

Contactos úteis • Useful contacts Contacts utiles • Contactos útiles

Serviço de Apoio ao Cliente (SAC) • Customer Support Service
Service Client • Servicio de Atención al Cliente

WhatsApp
+351 968 624 035

E-mail
sac@barros-moreira.pt



Serviço Pós-Venda (SPV) • After-Sales Service
Service Après-Vente • Servicio Posventa

Tel:
808 203 870
(Chamada para a rede fixa nacional • National landline call
Appel vers le réseau fixe national • Llamada a la red fija nacional)

E-mail
spv@barros-moreira.pt

Encomendas • Orders
Commandes • Pedidos

Tel:
+351 262 837 630

E-mail
encomendas@barros-moreira.pt



Códigos dos móveis • Furniture codes • Codes de meubles • Códigos de muebles

Códigos de móvel sem puxador • Furniture code without handle • Codes de meuble sans poignée • Códigos de mueble sin tirador

40210

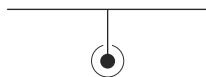

Código do móvel / módulo
furniture / module code
code du meuble / module
código del mueble / módulo

00



Código de acabamento estrutura
cabinet / structure finish code
cede de finition du caisson / structure
código del acabado del cuerpo / estructura

60



Código de acabamento da frente
front finish code
code de la finition de la façade
código del acabado del frente

Códigos de móvel com puxador • Furniture code with handle • Codes de meuble avec poignée • Códigos de mueble con tirador

_ _ 210

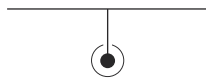

Código do puxador + móvel
handle + furniture code
code de la poignée + meuble
código del tirador + mueble

00



Código de acabamento estrutura
cabinet / structure finish code
cede de finition du caisson / structure
código del acabado del cuerpo / estructura

60



Código de acabamento da frente
front finish code
code de la finition de la façade
código del acabado del frente

Códigos das divisórias de duche • Shower enclosures codes • Codes de parois de duche • Códigos de las mamparas de ducha

30100

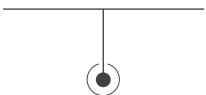

Código da cabine
(apresentado na tabela de preços)
Shower enclosure code
(presented in the price list)
code de cabine de douche
(présent dans la liste de prix)
código de la mampara
(presente en la lista de precios)

00



Código de acabamento do vidro
(disponível na página 192)
glass finish code
(available on page 192)
code de finition du verre
(disponible à la page 192)
código de acabado del vidrio
(disponible en la página 192)

00



Código de acabamento do metal
(disponível na página 190)
metal finish code
(available on page 190)
code de finition du métal
(disponible à la page 190)
código del acabado del metal
(disponible en la página 190)

CT 22223

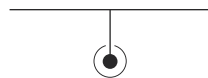

Código da torneira

Tap code
code de robinet
código del grifo

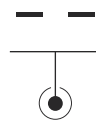

Código de acabamento

finish code
cede de finition
código del acabado

Acabamentos • finishes • finitions • acabados



00
cromado
chrome
chromé
cromo



01
satinox



02
ouro
gold
or
oro



03
ouro escovado
brushed gold
or brossé
oro cepillado



04
ouro mate
matte gold
or mat
oro mate



05
preto mate
matte black
noir mat
negro mate



06
branco mate
matte white
blanc mat
blanco mate



07
grafite mate
graphite matte
graphite mat
grafito mate



08
bronze escovado
brushed bronze
bronze brossé
bronze cepillado



09
bronze
bronze
bronze
bronce



25
cashmere mate
matte cashmere
cashmere mat
cashmere mate



40
vermelho brilho
bright red
rouge briller
rojo brillo



42
azul brilho
bright blue
bleu briller
azul brillo



44
amarelo brilho
bright yellow
jaune briller
amarillo brillo

Cores • colors • couleurs • colores
06 • 07 • 25 • 40 • 42 • 44

Metais • metals • métaux • metales
01 • 02 • 03 • 04 • 08 • 09

Sinalização de disponibilidade • Availability Signage • Signalisation de Disponibilité • Señalización de disponibilidad



Disponível imediato
Immediate availability
Disponibilité immédiate
Disponibilidad inmediata



Produção rápida (dias)
Fast production (days)
Production rapide (jours)
Producción rápida (días)



Produção normal (dias)
Standard production (days)
Production standard (jours)
Producción normal (días)



Produção por encomenda
Order production
Production à la demande
Producción bajo demanda



Produção a medida
Custom production
Production sur mesure
Producción a medida

Os prazos são estimados em dias úteis e podem sofrer variações sem aviso prévio • Lead times are estimated in business days and may vary without prior notice.
Les délais sont estimés en jours ouvrables et peuvent varier sans préavis. • Los plazos son estimados en días hábiles y pueden sufrir variaciones sin previo aviso.

Mobiliário de banho



The mark of
responsible forestry

Bathroom furniture · Meubles de salle de bains · Muebles de baño

O mobiliário de banho é um elemento central na casa de banho, unindo arrumação, organização e expressão estética. Os móveis Ctesi oferecem múltiplas opções para personalizar o espaço, tornando-o funcional, elegante e agradável, e adaptam-se a diferentes perfis de pessoas e estilos de vida, nos quais a qualidade, o design e a arrumação são essenciais.

Le mobilier de salle de bain est un élément central de la salle de bain, alliant rangement, organisation et expression esthétique. Les meubles Ctesi offrent de multiples options pour personnaliser l'espace, le rendant fonctionnel, élégant et agréable, et s'adaptent à différents profils et styles de vie, où la qualité, le design et le rangement sont essentiels.

Bathroom furniture is a central element in the bathroom, combining storage, organization, and aesthetic expression. Ctesi furniture offers multiple options to personalize the space, making it functional, elegant, and comfortable, while adapting to different lifestyles and personal profiles, where quality, design, and storage are essential.

El mobiliario de baño es un elemento central en el cuarto de baño, ya que combina almacenamiento, organización y expresión estética. Los muebles Ctesi ofrecen múltiples opciones para personalizar el espacio, haciéndolo funcional, elegante y acogedor, y se adaptan a diferentes perfiles de personas y estilos de vida, en los que la calidad, el diseño y la organización son esenciales.

As práticas ambientais, económicas e sociais que regem a Ctesi integram os princípios do referencial FSC® (Forest Stewardship Council®).

O mobiliário Ctesi, com certificação FSC® (código de certificação n.º SACOC-004972), é produzido a partir de materiais provenientes de florestas bem geridas certificadas FSC® e outras fontes controladas, que respeitam a biodiversidade e os direitos das comunidades que vivem e trabalham na floresta. Os produtos Ctesi com certificação FSC® estão disponíveis mediante solicitação.

Les pratiques environnementales, économiques et sociales qui guident CTESI intègrent les principes du référentiel FSC® (Forest Stewardship Council®). Le mobilier CTESI, certifié FSC® (code de certification n° SACOC-004972), est fabriqué à partir de matériaux issus de forêts certifiées FSC® bien gérées et d'autres sources contrôlées, respectant la biodiversité et les droits des communautés qui vivent et travaillent en forêt. Les produits CTESI certifiés FSC® sont disponibles sur demande.

The environmental, economic, and social practices that guide CTESI incorporate the principles of the FSC® (Forest Stewardship Council®) standards. CTESI furniture, certified FSC® (certificate code no. SACOC-004972), is produced using materials sourced from FSC®-certified well-managed forests and other controlled sources that respect biodiversity and the rights of the communities who live and work in the forest. FSC®-certified CTESI products are available upon request.

Las prácticas ambientales, económicas y sociales que rigen a CTESI integran los principios del estándar FSC® (Forest Stewardship Council®). El mobiliario CTESI, con certificación FSC® (código de certificación n.º SACOC-004972), se fabrica a partir de materiales procedentes de bosques bien gestionados certificados FSC® y de otras fuentes controladas, que respetan la biodiversidad y los derechos de las comunidades que viven y trabajan en el bosque. Los productos CTESI con certificación FSC® están disponibles bajo solicitud.



Móveis de banho

Muebles de baño · Bathroom furniture · Meubles de salle de bains

Móveis de Banho

O mobiliário de banho CTESI alia design, funcionalidade e arrumação, assumindo um papel central na organização e valorização do espaço. Concebido para se adaptar a diferentes estilos, perfis e necessidades, permite criar ambientes harmoniosos, pensados ao detalhe para o seu dia a dia.

Meubles de salle de bain

Le mobilier de salle de bain CTESI allie design, fonctionnalité et rangement, jouant un rôle central dans l'organisation et la valorisation de l'espace. Conçu pour s'adapter à différents styles, profils et besoins, il permet de créer des environnements harmonieux, pensés dans les moindres détails pour votre quotidien

Bathroom Furniture

CTESI bathroom furniture blends design, functionality, and smart storage. Adaptable to different styles and needs, it helps create harmonious, well-organized spaces, thoughtfully designed for everyday living.

Muebles de Baño

El mobiliario de baño CTESI combina diseño, funcionalidad y almacenamiento, desempeñando un papel central en la organización y valorización del espacio. Diseñado para adaptarse a diferentes estilos, perfiles y necesidades, permite crear ambientes armoniosos, pensados al detalle para su día a día.

18.	IGNIS	74.	SADO
24.	MINIMAL	78.	SADO MODULAR
28.	LINEA	82.	RUSTIK
38.	TAGUS	86.	ANCHOR
42.	LATUS	90.	SPOT
46.	FIRM	94.	TWICE
50.	ALUMINIUS	98.	NEXUS
54.	COPPER	102.	DEKO
58.	ARK	106.	RAKI
62.	OPEN	110.	ZIP
66.	RAK	114.	RYO
70.	PAX	118.	LAVATÓRIOS



efesi

móveis

espelhos

torneiras

acessórios
de banho

divisórias

bases e
banheiras

sistemas de
instalação

coleções
sanitárias

espaços
públicos

STÄDTLER
rasoplast

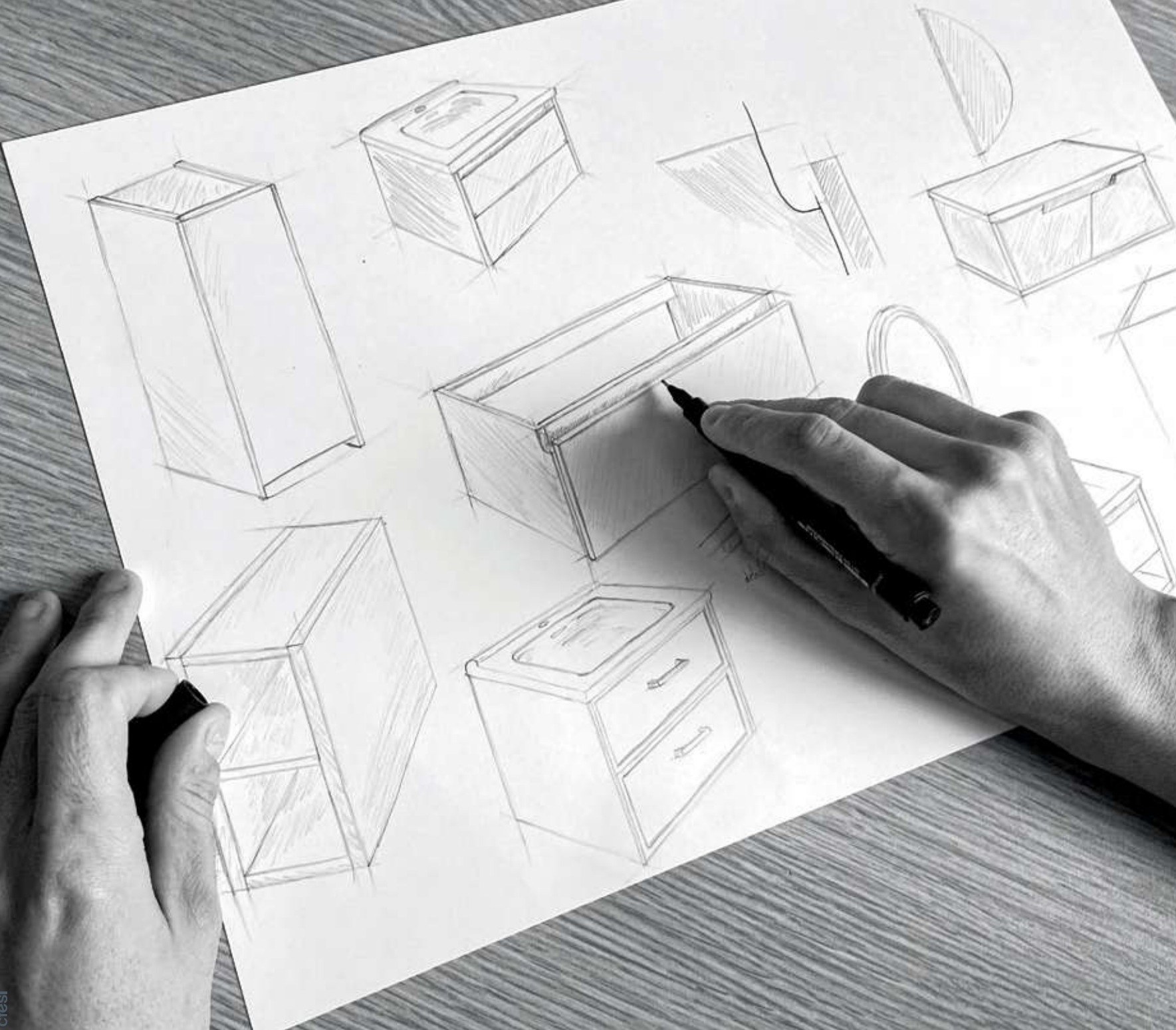

personalize

SOLUÇÕES À SUA MEDIDA

A CTESI desenvolve móveis de banho em lacados e com texturas de madeira refinadas, concebidos para se adaptar ao seu espaço e refletir o seu estilo, criando ambientes únicos e harmoniosos.

SOLUTIONS SUR MESURE

CTESI développe des meubles de salle de bain laqués et aux textures bois raffinées, conçus pour s'adapter à votre espace et refléter votre style, créant des environnements uniques et harmonieux.

TAILOR-MADE SOLUTIONS

CTESI develops bathroom furniture in lacquered finishes and refined wood textures, designed to adapt to your space and reflect your style, creating unique and harmonious environments.

SOLUCIONES A SU MEDIDA

CTESI desarrolla muebles de baño lacados y con texturas de madera refinadas, diseñados para adaptarse a su espacio y reflejar su estilo, creando ambientes únicos y armoniosos.



Escolha a estrutura do móvel e o tipo de lavatório.

Choose the cabinet structure and washbasin type.

Choisissez la structure du meuble et le type de lavabo.

Elija la estructura del mueble y el tipo de lavabo.



Defina se é suspenso ou com pés e selecione o acabamento dos pés e puxadores.

Select wall-mounted or with legs, and define the leg and handle finishes.

Definissez si le meuble est suspendu ou avec pieds et sélectionnez la finition des pieds et des poignées.

Defina si es suspendido o con patas y seleccione el acabado de las patas y los tiradores.



Opte entre as texturas de madeira ou um acabamento à sua cor, mate ou brilho.

Pick from wood textures or a lacquered finish in matte or gloss.

Optez pour différentes textures de bois ou une finition à votre couleur, mate ou brillante.

Opte entre diversas texturas de madeira o un acabado en su color, mate o brillo.

Acabamentos

Finishes • Finitions • Acabados

* Lacados com acabamento brilho ou mate
Lacquered with glossy or matte finish
Laqués avec finition brillante ou mate
Lacados de alto brillo o mate

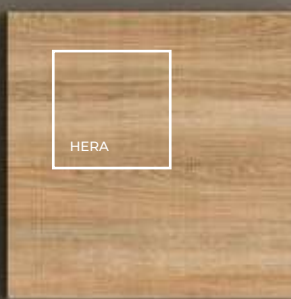
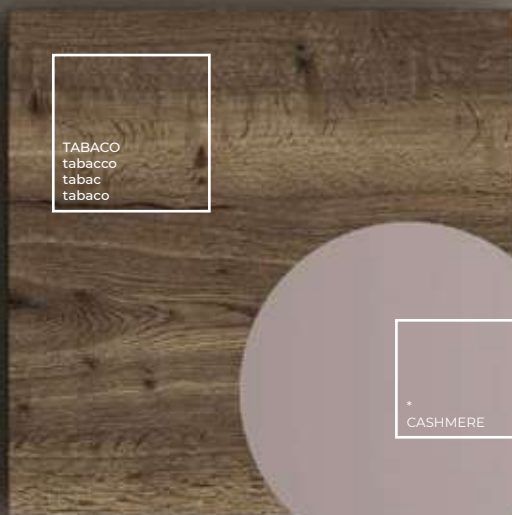
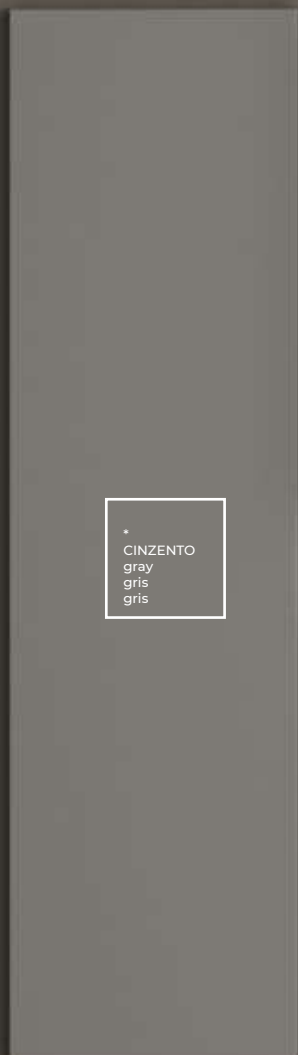

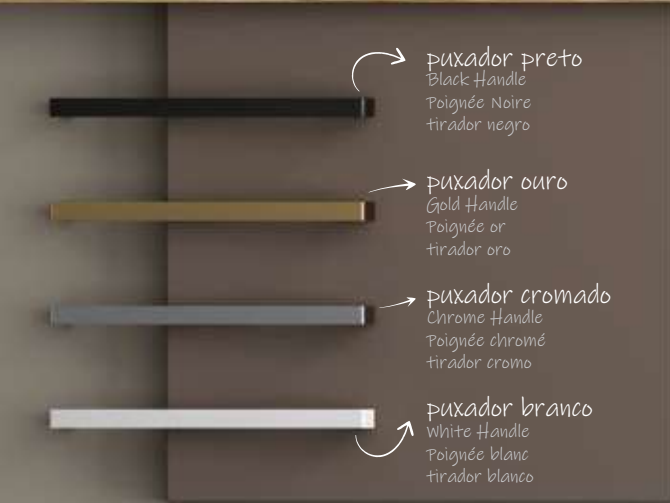
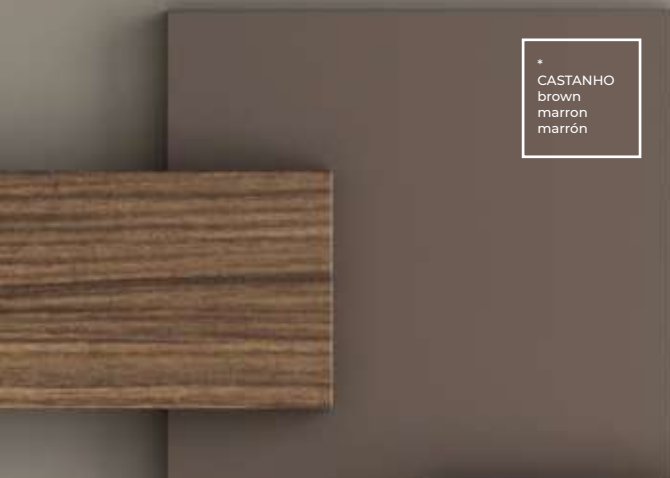

→ textura ignis
Ignis Texture



ctesi

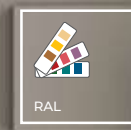

RAL



Ignis



Móvel 80cm - cashmere · Lavatório modern · Monocomando lavatório - Type · Espelho Rink 80cm c/led
Vanity 80cm - cashmere · Modern basin - Basin mixer - Type · Rink mirror 80cm with LED
Meuble 80cm - cachemire · Lavabo modern · Mitigeur lavabo - Type · Miroir Rink 80cm avec LED
Mueble 80cm - cashmere · Encimera modern · Monomando lavabo - Type · Espejo Rink 80cm c/led



Móvel 100cm - branco · Lavatório Right · Monocomando lavatório - Plane · Espelho Tag 100cm c/led
Vanity 100cm - white · Right basin · Basin mixer - Plane · Tag mirror 100cm with LED
Meuble 100cm - blanc · Lavabo Right · Mitigeur lavabo - Plane · Miroir Tag 100cm avec LED
Mueble 100cm - blanco · Encimera Right · Monomando lavabo - Plane · Espejo Tag 100cm c/led





Móvel 120cm - castanho com puxador preto · Coluna 35x140cm · Lavatório cerâmico - Modern duo · Monocomando lavatório - Type · Espelho Aura (2x)
Vanity 120cm - brown with black handle · Column 35x140cm · Ceramic basin - Modern duo · Basin mixer - Type · Aura mirror (2x)
Meuble 120cm - marron avec poignée noire · Colonne 35x140cm · Lavabo en céramique - Modern duo · Mitigeur lavabo - Type · Miroir Aura (2x)
Mueble 120cm - marrón con tirador negro · Columna 35x140cm · Lavabo cerámico - Modern duo · Monomando lavabo - Type · Espejo Aura (2x)

Móvel com lavatório · Vanity with basin · Meuble avec lavabo · Mueble con lavabo

⌚ 45 ⌚ 50

**60cm**

-- 000 --

Branco · white
blanc · blanco

530,00 €

Cores · colors
couleurs · colores

620,00 €

RAL

700,00 €

**80cm**

-- 001 --

605,00 €

705,00 €

805,00 €

**80cm**

-- 010 --

720,00 €

860,00 €

1 010,00 €

**80cm**

-- 020 --

720,00 €

860,00 €

1 010,00 €

**100cm**

-- 002 --

Branco · white
blanc · blanco

720,00 €

Cores · colors
couleurs · colores

830,00 €

RAL

940,00 €

**100cm**

-- 011 --

880,00 €

1 040,00 €

1 200,00 €

**100cm**

-- 021 --

880,00 €

1 040,00 €

1 200,00 €

**100cm**

-- 012 --

890,00 €

1 050,00 €

1 210,00 €

**100cm**

-- 022 --

890,00 €

1 050,00 €

1 210,00 €

centro · center
centre · centro**120cm**

-- 003 --

Branco · white
blanc · blanco

880,00 €

Cores · colors
couleurs · colores

1 000,00 €

RAL

1 130,00 €

duplo 2 gavetas · double 2 drawers
double 2 tiroirs · doble 2 cajones**120cm**

-- 055 --

890,00 €

1 010,00 €

1 140,00 €

duplo 4 gavetas · double 4 drawers
double 4 tiroirs · doble 4 cajones**120cm**

-- 004 --

1 060,00 €

1 180,00 €

1 310,00 €

Coluna · Column
Colonne · Columna**30x35x140cm**

-- 070 --

430,00 €

520,00 €

600,00 €

**120cm**

-- 015 --

Branco · white
blanc · blanco

1 040,00 €

Cores · colors
couleurs · colores

1 210,00 €

RAL

1 380,00 €

**120cm**

-- 025 --

1 040,00 €

1 210,00 €

1 380,00 €

**120cm**

-- 016 --

1 040,00 €

1 210,00 €

1 380,00 €

**120cm**

-- 026 --

1 040,00 €

1 210,00 €

1 380,00 €



Móvel 120cm - verde olíva mate · Lavatório cerâmico 121cm - Left · Monocomando lavatório - Smooth · Espelho Liso 60x80cm
 Vanity 120cm - matte olive green · Ceramic basin 121cm - Left · Basin mixer - Smooth · Liso mirror 60x80cm
 Meuble 120cm - vert olive mat · Lavabo en céramique 121cm - Gauche · Mitigeur lavabo - Smooth · Miroir Liso 60x80cm
 Mueble 120cm - verde olíva mate · Encimera de lavabo cerámico 121cm - Left · Monomando lavabo - Smooth · Espejo Liso 60x80cm

Kit puxadores · Handles kit
 Kit poignées · Kit manijas

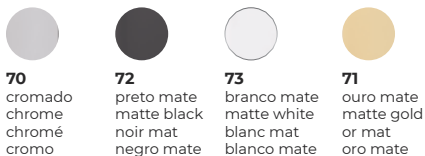

70
cromado
chrome
chromé
cromo

72
preto mate
matte black
noir mat
negro mate

73
branco mate
matte white
blanc mat
blanco mate

71
ouro mate
matte gold
or mat
oro mate

10

15

Lacado mate · matt lacquered
 laqué mat · lacado mate



20
branco
white
blanc
blanco

24
cinzento
gray
gris
gris

25
cashmere

26
castanho
brown
marron
marrón

32
verde olíva
olive green
vert olive
verde olíva

29
azul claro
light blue
bleu clair
azul claro

30
azul
blue
bleu
azul

22
antracite
anthracite
antracita

21
preto
black
noir
negro

ral

Minimal



Móvel 80cm - castanho e nogueira
Lavatório de pousar Nevada
Monocomando lavatório alto - Smooth
Espelho Illusion

Vanity 80cm - brown and walnut
Ceramic countertop basin - Nevada
Tall basin mixer - Smooth
Illusion mirror

Meuble 80cm - marron et noyer
Lavabo en céramique à poser Nevada
Mitigeur lavabo haut - Smooth
Miroir Illusion

Mueble 80cm - marrón y nogal
Lavabo cerámico sobre encimera Nevada
Monomando lavabo alto - Smooth
Espéjo Illusion

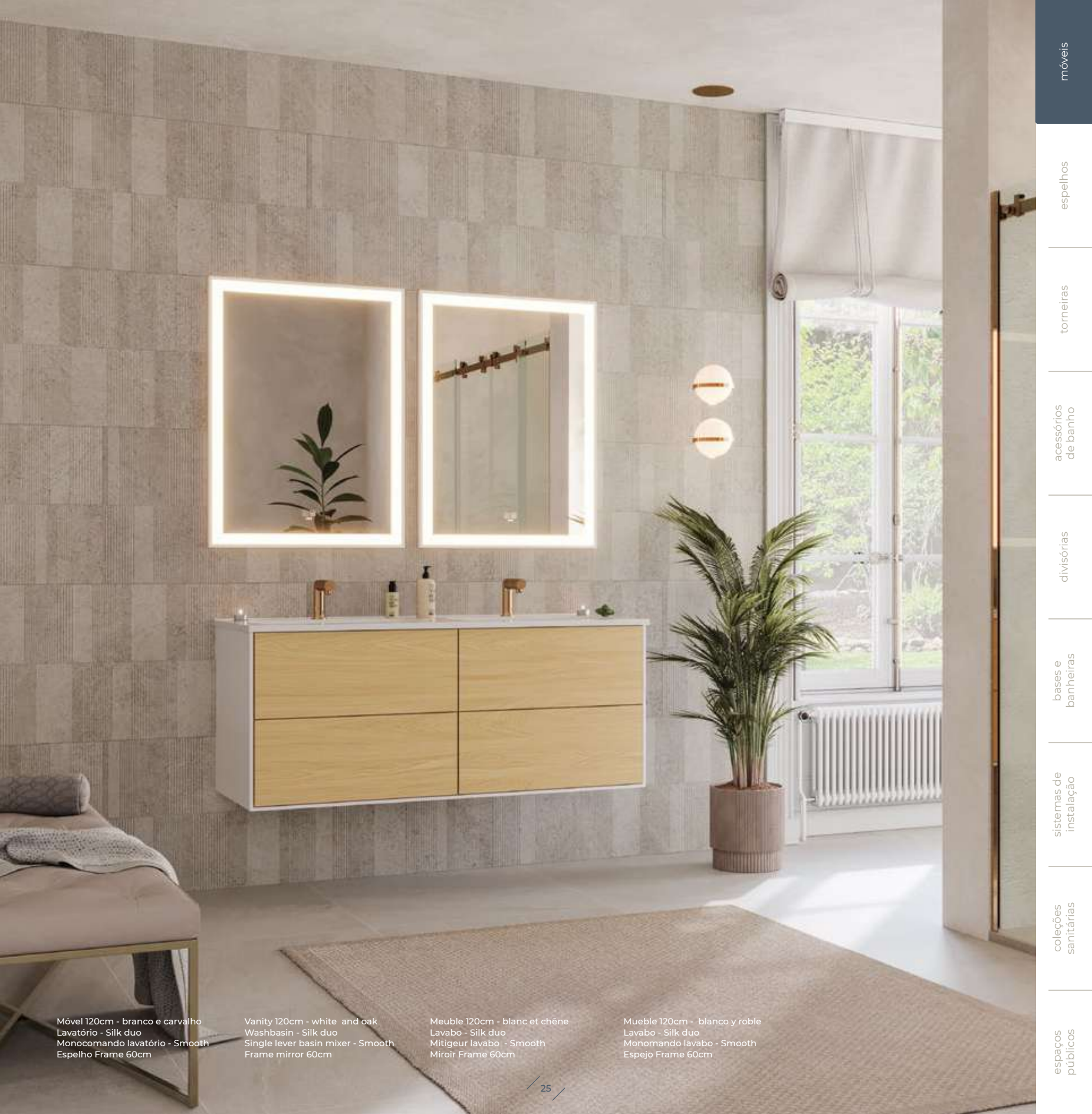

Móvel 120cm - branco e carvalho
Lavatório - Silk duo
Monocomando lavatório - Smooth
Espelho Frame 60cm

Vanity 120cm - white and oak
Washbasin - Silk duo
Single lever basin mixer - Smooth
Frame mirror 60cm

Meuble 120cm - blanc et chêne
Lavabo - Silk duo
Mitigeur lavabo - Smooth
Miroir Frame 60cm

Mueble 120cm - blanco y roble
Lavabo - Silk duo
Monomando lavabo - Smooth
Espejo Frame 60cm

Móvel com lavatório · Vanity with basin · Meuble avec lavabo · Mueble con lavabo

🕒 45 🕒 50

	60cm 81300	80cm 81310	100cm 81320	120cm 81330
Branco / Branco ou texturas · White / White or textures Blanc / Blanc ou textures · Blanco / Blanco o texturas	505,00 €	590,00 €	690,00 €	910,00 €
Branco / Carvalho · White / Oak Blanc / Chêne · Blanco / Roble	660,00 €	750,00 €	850,00 €	1 080,00 €
Cores / Cores ou texturas · Colors / Colors or textures Couleurs / Couleurs ou textures · Colores / Colores o texturas	585,00 €	690,00 €	800,00 €	1 040,00 €
Cores / Carvalho · Colors / Oak Couleurs / Chêne · Colores / Roble	740,00 €	850,00 €	960,00 €	1 210,00 €
RAL / Texturas · RAL / Textures RAL / Textures · RAL / Texturas	665,00 €	790,00 €	910,00 €	1 160,00 €
RAL / Carvalho · RAL / Oak RAL / Chêne · RAL / Roble	820,00 €	950,00 €	1 070,00 €	1 330,00 €

Móvel com tampo · Vanity with countertop · Meuble avec comptoir · Mueble con encimera

	60cm 41301	80cm 41311	100cm 41321	120cm 41331
Branco / Texturas · White / Textures Blanc / Textures · Blanco / Texturas	445,00 €	475,00 €	660,00 €	920,00 €
Branco / Carvalho · White / Oak Blanc / Chêne · Blanco / Roble	660,00 €	720,00 €	805,00 €	1 060,00 €
Cores / Texturas · Colors / Textures Couleurs / Textures · Colores / Texturas	525,00 €	575,00 €	770,00 €	1 050,00 €
Cores / Carvalho · Colors / Oak Couleurs / Chêne · Colores / Roble	740,00 €	820,00 €	915,00 €	1 190,00 €
RAL / Texturas · RAL / Textures RAL / Textures · RAL / Texturas	605,00 €	675,00 €	880,00 €	1 170,00 €
RAL / Carvalho · RAL / Oak RAL / Chêne · RAL / Roble	820,00 €	920,00 €	1 025,00 €	1 310,00 €

15

Textura de madeira · Wood texture
Texture du bois · Textura de mader



92 oak	82 cerejo cerez cherry cerisier	88 riga alerce larch mélèze	86 hera	93 nut	83 tabaco tobacco tabac tabaco	84 nogal walnut noyer nogal	89 mocca
------------------	--	--	-------------------	------------------	---	--	--------------------

20

Carvalho natural · natural oak
chêne naturel · roble natural



70	71	72	73	74	75
-----------	-----------	-----------	-----------	-----------	-----------

Lacado mate · matt lacquered
laqué mat · lacado mate



20 branco white blanc blanco	24 cinzento gray gris gris	25 cashmere	26 castanho brown brun marrón	32 verde oliva olive green vert olive verde oliva	29 azul claro light blue bleu clair azul claro	30 azul blue bleu azul	22 antracite anthracite anthracite antracita	21 preto black noir negro	ral
---	---	-----------------------	--	--	---	---	---	--	-----



Móvel 60cm - verde oliva | Lavatório cerâmico - Nevada | Monocomando lavatório de encastrar - Type Duo | Espelho Rise 60cm
Vanity 60cm - olive green | Ceramic basin - Nevada | Built-in basin mixer - Type Duo | Rise mirror 60cm
Meuble 60cm - vert olive | Lavabo en céramique - Nevada | Mítigeur lavabo encastré - Type Duo | Miroir Rise 60cm
Mueble 60cm - verde oliva | Encimera de lavabo cerámico - Nevada | Monomando lavabo de empotrar - Type Duo | Espejo Rise 60cm

móveis

espelhos

torneiras

acessórios
de banho

divisórias

bases e
banheiras

sistemas de
instalação

coleções
sanitárias

espaços
públicos



Móvel 100cm, (20+60+20cm) - branco e nut · Lavatório modern · Monocomando lavatório - Knobe · Espelho Aura c/led
Vanity 100cm (20+60+20cm) - white and nut · Modern basin · Basin mixer - Knobe · Aura mirror with LED
Meuble 100cm (20+60+20cm) - blanc et noisette · Vasque moderne · Mitigeur lavabo - Knobe · Miroir Aura avec LED
Mueble 100cm (20+60+20cm) - blanco y nut · Encimera modern · Monomando lavabo - Knobe · Espejo Aura c/LED

Móvel 140cm (20+80+40cm) - castanho · Lavatório Alba · Torneira de encastrar - Star · Espelho Tag 80cm
 Vanity 140cm (20+80+40cm) - brown · Alba basin · Built-in faucet - Star · Tag mirror 80cm
 Meuble 140cm (20+80+40cm) - marron · Vasque Alba · Robinet encastré - Star · Miroir Tag 80cm
 Mueble 140cm (20+80+40cm) - marrón · Encimera Alba · Grifo empotrado - Star · Espejo Tag 80cm



Móvel 180cm (20+60+20+60+20cm) - cinzento e nogal · Lavatório solid surface de pousar Vory · Monocomando lavatório alto - Type · Espelho Frame 60cm c/ led
 Vanity 180cm (20+60+20+60+20cm) - gray and walnut · Vory solid surface countertop basin · Tall basin mixer - Type · Frame mirror 60cm with LED
 Meuble 180cm (20+60+20+60+20cm) - gris et noyer · Vasque à poser en solid surface Vory · Mitigeur lavabo haut - Type · Miroir Frame 60cm avec LED
 Mueble 180cm (20+60+20+60+20cm) - cinzento e nogal · Lavabo solid surface sobre encimera Vory · Monomando lavabo alto - Type · Espejo Frame 60cm c/led

26 cm altura
26 cm height
26 cm de hauteur
26 cm altura



Móvel 60/70/80/100
Vanity
Meuble
Mueble



Modulo c/ porta - 40cm
Module with door
Module avec porte
Mueble c/ puerta



Modulo prateleira - 20cm
Shelf module
Module étagère
Módulo estante

50 cm altura
50 cm height
50 cm de hauteur
50 cm de hauteur



Móvel 60/70/80/100
Vanity
Meuble
Mueble



Modulo prateleira - 20cm
Shelf module
Module étagère
Módulo estante



Modulo c/ porta - 20cm
Module with door
Module avec porte
Mueble c/ puerta



Módulo tulha 40cm
Tulip module
Module tulipe
Módulo cesto



Bancada - Rak 120cm · Módulo 1 gaveta 40cm + móvel 1 gaveta 60cm + 1 módulo prateleira 20cm + tampo madeira 120cm - branco mate
Lavatório Nevada · Monocomando lavatório alto - Type · Espelho Sunset 100cm c/led

Countertop - Rak 120cm · 1 drawer module 40cm + 1 drawer vanity 60cm + 1 shelf module 20cm + wood countertop 120cm - matte white
Nevada basin · Tall basin mixer - Type · Sunset mirror 100cm with LED

Plateau - Rak 120cm · Module 1 tiroir 40cm + meuble 1 tiroir 60cm + 1 module étagère 20cm + plateau bois 120cm - blanc mat
Vasque Nevada · Mítigeur lavabo haut - Type · Miroir Sunset 100cm avec LED

Bancada - Rak 120cm · Módulo 1 cajón 40cm + mueble 1 cajón 60cm + 1 módulo prateleira 20cm + encimera de madeira 120cm - blanco mate
Lavabo Nevada · Monomando para lavabo alto - Type · Espejo Sunset 100cm con LED

Móvel 1 gaveta · 1-drawer vanity · Meuble 1 tiroir · Mueble 1 cajón

🕒 45 ⓘ 26



60cm
50221_ _ _ _

Branco/ Texturas · White/textures
Blanc/textures · Blanco/textures

185,00 €

Cores · Colors
Couleurs · Colores

260,00 €

RAL

330,00 €



70cm
50222_ _ _ _

195,00 €

270,00 €

350,00 €



80cm
50223_ _ _ _

200,00 €

285,00 €

370,00 €



100cm
50225_ _ _ _

230,00 €

390,00 €

490,00 €

Módulos · Modules
Módulos · Módulos

Prateleira · Shelf
Étagère · Balda



20cm
50210_ _ _ _

Branco/ Texturas · White/textures
Blanc/textures · Blanco/textures

85,00 €

Cores · Colors
Couleurs · Colores

125,00 €

RAL

170,00 €

Porta · Door
Porte · Puerta



40cm
50216_ _ _ _

115,00 €

155,00 €

200,00 €

Coluna · Column
Colonne · Columna



27x30x120cm
50700_ _ _ _

255,00 €

355,00 €

455,00 €

Tampo · Countertop · Plateau · Encimera

	60cm 50270_ _ _ _	70cm 50277_ _ _ _	80cm 50271_ _ _	100cm 50272_ _ _	120cm 50273_ _ _	130cm 50274_ _ _	140cm 50275_ _ _	160cm 50276_ _ _	170cm 50278_ _ _	180cm 50279_ _ _
Branco/ Texturas · White/textures Blanc/textures · Blanco/textures	70,00 €	75,00 €	85,00 €	100,00 €	110,00 €	130,00 €	145,00 €	175,00 €	190,00 €	205,00 €
Cores · Colors Couleurs · Colores	105,00 €	110,00 €	120,00 €	145,00 €	160,00 €	175,00 €	190,00 €	230,00 €	250,00 €	265,00 €
RAL	140,00 €	145,00 €	155,00 €	195,00 €	205,00 €	220,00 €	240,00 €	290,00 €	305,00 €	325,00 €

Lavatório cerâmico · Ceramic basin · Vasque en céramique · Lavabo cerámico

centrado · centered · centré · centrado

	60cm BL6002100	70cm BL6002105	80cm BL6002110	100cm BL6002120	120cm BL6002130
Branco · Blanco · White · Blanc	80,00 €	90,00 €	100,00 €	130,00 €	190,00 €

duplo
double
double
double

a direita · on the Right
à Droite · a la derecha

a esquerda · on the Left
à Gauche · a la izquierda

	120cm BL6002135	80cm BL6001110	100cm BL6001120	120cm BL6001130	80cm BL6001000	100cm BL6001020	120cm BL6001030
Branco · Blanco · White · Blanc	210,00 €	110,00 €	180,00 €	240,00 €	110,00 €	180,00 €	240,00 €

Móvel 2 gavetas · Vanity with 2 drawers · Meuble 2 tiroirs · Mueble 2 cajones

45 50

60cm
50231_ _ _

Branco/ Texturas · White/textures
Blanc/textures · Blanco/textures

280,00 €

Cores · Colors
Couleurs · Colores

360,00 €

RAL

440,00 €

70cm
50232_ _ _

285,00 €

370,00 €

465,00 €

80cm
50233_ _ _

290,00 €

390,00 €

490,00 €

100cm
50235_ _ _

330,00 €

430,00 €

540,00 €

espelhos

torneiras

Módulos · Modules
Módulos · Módulos

45 50

Prateleira · Shelf
Étagère · Balda

20cm
-- 50212 _ _ _

Branco/ Texturas · White/textures
Blanc/textures · Blanco/textures

125,00 €

Cores · Colors
Couleurs · Colores

185,00 €

RAL

240,00 €

Porta · Door
Porte · Puerta

20cm
50217_ _ _

140,00 €

200,00 €

260,00 €

Porta · Door
Porte · Puerta

40cm
50218_ _ _

170,00 €

230,00 €

285,00 €

Tulha · Bin
Poubelle · Cesto

40cm
50219_ _ _

260,00 €

315,00 €

375,00 €

 acessórios
de banho

divisórias

 bases e
banheiras

15

Textura de madeira · Wood texture
Texture du bois · Textura de madera

92
oak

82
cerejo
cherry
cerisier

88
riga
alerce
larch
mélèze

86
hera

93
nut

83
tabaco
tobacco
tabac
tabaco

84
nogal
walnut
noyer
nogal

89
mocca

 sistemas de
instalação

Lacado mate · matt lacquered
laqué mat · lacado mate

20
branco
white
blanc
blanco

24
cinzento
gray
gris
gris

25
cashmere

26
castanho
brown
brun
marrón

32
verde oliva
olive green
vert olive
verde oliva

29
azul claro
light blue
bleu clair
azul claro

30
azul
blue
bleu
azul

22
antracite
anthracite
anthracite
antracita

21
preto
black
noir
negro

ral

 coleções
sanitárias

 espaços
públicos

Móvel com lavatório · Vanity with basin · Meuble avec lavabo · Mueble con lavabo

④ 45 ① 50

④ 45 ① 26



60cm

70221_ _ _



70cm

70222_ _ _



80cm

70223_ _ _



100cm

77225_ _ _



60cm

70231_ _ _



70cm

70232_ _ _



80cm

70233_ _ _



100cm

70235_ _ _

Branco/ Texturas · White/textures
Blanc/textures · Blanco/textures

265,00 €

285,00 €

300,00 €

360,00 €

360,00 €

375,00 €

390,00 €

460,00 €

Cores · Colors
Couleurs · Colores

340,00 €

360,00 €

380,00 €

470,00 €

440,00 €

470,00 €

490,00 €

570,00 €

RAL

425,00 €

440,00 €

470,00 €

570,00 €

530,00 €

560,00 €

590,00 €

690,00 €

Móvel com tampo · Vanity with countertop · Meuble avec plateau · Mueble con encimera

④ 47 ① 50

④ 45 ① 26



60cm

70240_ _ _



70cm

70241_ _ _



80cm

70242_ _ _



100cm

70244_ _ _



60cm

70250_ _ _



70cm

70251_ _ _



80cm

70252_ _ _



100cm

70254_ _ _

Branco/ Texturas · White/textures
Blanc/textures · Blanco/textures

245,00 €

260,00 €

270,00 €

310,00 €

330,00 €

345,00 €

360,00 €

400,00 €

Cores · Colors
Couleurs · Colores

325,00 €

350,00 €

370,00 €

430,00 €

425,00 €

450,00 €

470,00 €

525,00 €

RAL

420,00 €

435,00 €

470,00 €

540,00 €

520,00 €

550,00 €

585,00 €

655,00 €

Coluna · Column · Colonne · Columna



27x30x120cm

50700_ _ _

Branco/ Texturas · White/textures
Blanc/textures · Blanco/textures

255,00 €

Cores · Colors
Couleurs · Colores

355,00 €

RAL

455,00 €

15

Textura de madeira · Wood texture
Texture du bois · Textura de madera92
oak82
cerejo
cerez
cherry
cerisier88
riga
alerce
larch
mélèze86
hera93
nut83
tabaco
tobacco
tabac
tabaco84
nogal
walnut
noyer
nogal89
moccaLacado mate · matt lacquered
laqué mat · lacado mate20
branco
white
blanc
blanco24
cinzento
gray
gris
gris25
cashmere26
castanho
brown
brun
marrón32
verde oliva
olive green
vert olive
verde oliva29
azul claro
light blue
bleu clair
azul claro30
azul
blue
bleu
azul22
antracite
anthracite
anthracite
antracita21
preto
black
noir
negro

ral



Móvel 100cm - tabaco · Lavatório Nevada · Monocomando lavatório alto - Pipeline · Espelho Join 100cm c/led
Vanity 100cm - tobacco · Nevada basin · Tall basin mixer - Pipeline · Join mirror 100cm with LED
Meuble 100cm - tabac · Lavabo Nevada · Mitigeur haut pour lavabo - Pipeline · Miroir Join 100cm avec LED
Mueble 100cm - tabaco · Encimera Nevada · Monomando lavabo alto - Pipeline · Espejo Join 100cm c/led

Tagus



Móvel 100cm - hera · Lavatório cerâmico de pousar - Cotton · Monocomando lavatório alto - Keen · Espelho Alva 60x100cm · Coluna Linea - hera
Vanity 100 cm - hera wood · Above-counter ceramic basin - Cotton · Tall basin mixer tap - Keen · Mirror Alva 60x100 cm · Column Linea - hera wood
Meuble 100 cm - bois hera · Lavabo céramique à poser - Cotton · Mitigeur lavabo haut - Keen · Miroir Alva 60x100 cm · Colonne Linea - bois hera
Mueble 100cm - hera · Lavabo cerámico sobre encimera - Cotton · Monomando lavabo alto - Keen · Espejo Alva 60x100cm · Columna Linea - hera



Móvel 80cm - nogal · Lavatório cerâmico 81cm - Left · Monocomando lavatório - Type · Espelho Luna 80cm
Vanity 80 cm - nogal · Ceramic basin 81 cm - Left · Basin mixer tap - Type · Mirror Luna 80 cm
Meuble 80 cm - noyer · Lavabo en céramique 81 cm - Left · Mitigeur lavabo - Type · Miroir Luna 80 cm
Mueble 80cm - walnut · Encimera de lavabo cerámico 81cm - Left · Monomando lavabo - Type · Espejo Luna 80cm

Móvel com lavatório · Vanity with basin
Meuble avec lavabo · Mueble con lavabo

🕒 45 🕒 50



80cm

82700 __

Branco · White
Blanc · Blanco

430,00 €

Texturas de madeira · Wood textures
Texture du bois · Texturas de madera

430,00 €

Cores · Colors
Couleurs · Colores

530,00 €

RAL

630,00 €



80cm

82701 __

430,00 €

430,00 €

530,00 €

630,00 €



100cm

82702 __

540,00 €

540,00 €

650,00 €

760,00 €



100cm

82703 __

540,00 €

540,00 €

650,00 €

760,00 €



120cm

82704 __

670,00 €

670,00 €

790,00 €

910,00 €



120cm

82705 __

670,00 €

670,00 €

790,00 €

910,00 €

Coluna Linea · Column
Colonne · Columna



27x30x120cm

50700 __ __

255,00 €

255,00 €

355,00 €

455,00 €

Móvel com tampo · Vanity with countertop
Meuble avec plateau · Mueble con encimera

🕒 45 🕒 50



80cm

82710 __

Branco · White
Blanc · Blanco

360,00 €

Texturas de madeira · Wood textures
Texture du bois · Texturas de madera

360,00 €

Cores · Colors
Couleurs · Colores

480,00 €

RAL

600,00 €



80cm

82711 __

360,00 €

360,00 €

480,00 €

600,00 €



100cm

82712 __

420,00 €

420,00 €

550,00 €

660,00 €



100cm

82713 __

420,00 €

420,00 €

550,00 €

660,00 €



120cm

82714 __

460,00 €

460,00 €

610,00 €

740,00 €



120cm

82715 __

460,00 €

460,00 €

610,00 €

740,00 €

STOCK

15

Lacado brilho · glossy lacquered
laqué brillant · lacado brilho



00
branco
white
blanc
blanco



01
preto
black
noir
negro



02
antracite
anthracite
antracita



04
cinzento
gray
gris
gris



92
oak



82
cerejo
cerez
cherry
cerisier



88
riga
alerce
larch
mélèze



86
hera



93
nut



83
tabaco
tobacco
tabac
tabaco



84
nogal
walnut
noyer
nogal



89
mocca



ral



Móvel 120cm - branco · Lavatório cerâmico 121cm - Left · Monocomando lavatório - Spirit · Espelho Luna 60cm
Vanity 120 cm - white · Ceramic basin 121 cm - Left · Basin mixer tap - Spirit · Mirror Luna 60 cm
Meuble 120 cm - blanc · Lavabo en céramique 121 cm - Left · Mitigeur lavabo - Spirit · Miroir Luna 60 cm
Mueble 120cm - blanco · Encimera de lavabo cerámico 121cm - Left · Monomando lavabo - Spirit · Espejo Luna 60cm

móveis

espelhos

torneiras

acessórios
de banho

divisórias

bases e
banheiras

sistemas de
instalação

coleções
sanitárias

espaços
públicos

Latus



Móvel 100cm - oak · Lavatório cerâmico de pousar - Nevada · Monocomando lavatório - Spirit · Espelho ALVA 80cm
Mueble 100cm - oak · Lavabo cerâmico sobre encimera - Nevada · Monocomando lavabo - Spirit · Espejo ALVA 80
Vanity 100 cm - oak · Above-counter ceramic basin - Nevada · Basin mixer tap - Spirit · Mirror ALVA 80 cm
Meuble 100 cm - oak · Lavabo céramique à poser - Nevada · Mitigeur lavabo - Spirit · Miroir ALVA 80 cm



Móvel 80cm · Lavatório cerâmico 81cm - Left · Monocomando lavatório - Spirit · Espelho Aura c/ led
Mueble 80cm · Encimera de lavabo cerâmico 81cm - Left · Monomando lavabo - Spirit · Espejo Aura c/ led
Vanity 80 cm · Ceramic basin 81 cm - Left · Basin mixer tap - Spirit · Mirror Aura with led
Meuble 80 cm · Lavabo en céramique 81 cm - Left · Mitigeur lavabo - Spirit · Miroir Aura avec led

Móvel com lavatório · Vanity with basin
Meuble avec lavabo · Mueble con lavabo

🕒 45 📦 50



80cm

81511 __

Branco · White
Blanc · Blanco

405,00 €

Texturas de madeira · Wood textures
Texture du bois · Texturas de madera

405,00 €

Cores · Colors
Couleurs · Colores

505,00 €

RAL

605,00 €



80cm

81512 __

405,00 €

405,00 €

505,00 €

605,00 €



100cm

81521 __

520,00 €

520,00 €

630,00 €

740,00 €



100cm

81522 __

520,00 €

520,00 €

630,00 €

740,00 €



120cm

81531 __

640,00 €

640,00 €

760,00 €

880,00 €



120cm

81532 __

640,00 €

640,00 €

760,00 €

880,00 €

Coluna Linea · Column
Colonne · Columna



27x30x120cm

50700 __ __

255,00 €

255,00 €

355,00 €

455,00 €

Móvel com tampo · Vanity with countertop
Meuble avec plateau · Mueble con encimera

🕒 45 📦 50



80cm

81513 __

Branco · White
Blanc · Blanco

330,00 €

Texturas de madeira · Wood textures
Texture du bois · Texturas de madera

330,00 €

Cores · Colors
Couleurs · Colores

430,00 €

RAL

530,00 €



80cm

81514 __

330,00 €

330,00 €

430,00 €

530,00 €



100cm

81523 __

390,00 €

390,00 €

500,00 €

610,00 €



100cm

81524 __

390,00 €

390,00 €

500,00 €

610,00 €



120cm

81533 __

435,00 €

435,00 €

555,00 €

675,00 €



120cm

81534 __

435,00 €

435,00 €

555,00 €

675,00 €

STOCK

15

Lacado brilho · glossy lacquered
laqué brillant · lacado brilho



00
branco
white
blanc
blanco



01
preto
black
noir
negro



02
antracite
anthracite
antracita



04
cinzento
gray
gris
gris

Textura de madeira · Wood texture
Texture du bois · Textura de madera



92
oak



82
cerejo
cerez
cherry
cerisier



88
riga
alerce
larch
mélèze



86
hera



93
nut



83
tabacco
tobacco
tabac
tabaco



84
nogal
walnut
noyer
nogal



89
mocca



ral



Móvel 100cm - nogal · Toalheiro auto-adesivo preto · Lavatório cerâmico 101cm - Left · Monocomando lavatório - Keen · Espelho Sunny 100cm c/led · Coluna Linea - nogal
Vanity 100 cm - walnut · Black self-adhesive towel rail · Ceramic basin 101 cm - Left · Basin mixer tap - Keen · Mirror Sunny 100 cm with led · Column Sunny 100 cm with led · Column Linea - walnut
Meuble 100 cm - noyer · Porte-serviette autocollant noir · Lavabo céramique 101 cm - Left · Mitigeur lavabo - Keen · Miroir Sunny 100 cm avec led · Colonne Linea - noyer
Mueble 100cm - nogal · Toallero autoadhesivo negro · Encimera de lavabo cerámico 101cm - Left · Monomando lavabo - Keen · Espejo Sunny 100cm c/led · Columna Linea nogal

Firm



Móvel 120cm - carvalho natural e branco · Lavatório cerâmico - Modern · Monocomando lavatório - Plane (2x) · Espelho Timer 120cm · Coluna Firm 140cm - carvalho natural e branco
Vanity 120cm - natural oak and white · Ceramic basin - Modern · Basin mixer - Plane (2x) · Timer mirror 120cm · Firm column 140cm - natural oak and white
Meuble 120cm - chêne naturel et blanc · Lavabo en céramique - Modern · Mitigeur lavabo - Plane (2x) · Miroir Timer 120cm · Colonne Firm 140cm - chêne naturel et blanc
Mueble 120cm - roble natural y blanco · Lavabo cerámico - Modern · Monomando lavabo - Plane (2x) · Espejo Timer 120cm · Columna Firm 140cm - roble natural y blanco Vanity 120cm -



Móvel 80cm - carvalho tabaco e branco - Lavatório solid surface Vory - Monocomando encastrar - Star duo - Espelho Timer 100cm c/led - Coluna Firm 140cm - carvalho tabaco e branco
Vanity 80cm - tobacco oak and white - Above-counter ceramic basin Tundra - Built-in mixer - Face duo - Timer mirror 80cm with LED - Firm column 140cm - tobacco oak and white
Meuble 80cm - chêne tabac et blanc - Lavabo en céramique à poser Tundra - Mitigeur encastré - Face duo - Miroir Timer 80cm avec LED - Colonne Firm 140cm - chêne tabac et blanc
Mueble 80cm - roble tabaco y blanco - Lavabo solid surface Vory - Monomando empotrado - Star duo - Espejo Timer 100cm c/led - Columna Firm 140cm - roble tabaco y blanco

Móvel com lavatório · Vanity with basin
Meuble avec lavabo · Mueble con lavabo

🕒 45 ⓘ 50



60cm
81000 _ _ _ _

Carvalho / Branco · Oak / White
Chêne / Blanc · Roble / Blanco

575,00 €

Carvalho / Cores · Oak / Colors
Chêne / Couleurs · Roble / Colores

655,00 €

Carvalho / RAL · Oak / RAL
Chêne / RAL · Roble / RAL

735,00 €



80cm
81010 _ _ _ _

660,00 €

760,00 €

860,00 €



100cm
81020 _ _ _ _

775,00 €

885,00 €

995,00 €



120cm
81030 _ _ _ _

975,00 €

1 095,00 €

1 235,00 €



Coluna · Column
Colonne · Columna

30x30x40cm
41070 _ _ _ _

520,00 €

600,00 €

680,00 €

Móvel com tampo · Vanity with countertop
Meuble avec plateau · Mueble con encimera

🕒 45 ⓘ 50



60cm
41001 _ _ _ _

Carvalho / Branco · Oak / White
Chêne / Blanc · Roble / Blanco

520,00 €

Carvalho / Cores · Oak / Colors
Chêne / Couleurs · Roble / Colores

600,00 €

Carvalho / RAL · Oak / RAL
Chêne / RAL · Roble / RAL

680,00 €



80cm
41011 _ _ _ _

605,00 €

705,00 €

805,00 €



100cm
41021 _ _ _ _

675,00 €

785,00 €

895,00 €



120cm
41031 _ _ _ _

790,00 €

910,00 €

1 050,00 €

15

Lacado brilho · glossy lacquered
laqué brillant · lacado brillo



00
branco
white
blanc
blanco



01
preto
black
noir
negro



02
antracite
anthracite
antracita



04
cinzento
gray
gris
gris



ral

Madeira natural · Natural wood
Bois naturel · Madera natural



78
carvalho natural
natural oak
chêne naturel
roble natural



79
carvalho tabaco
oak tobacco
chêne tabac
roble tabaco



Móvel 100cm - carvalho tabaco e branco · Lavatório cerâmico - Modern · Monocomando lavatório - Astra
Vanity 100cm - tobacco oak and white · Ceramic washbasin - Modern · Single lever basin mixer - Astra
Meuble 100cm - chêne tabac et blanc · Vasque en céramique - Modern · Mitigeur monocommande lavabo - Astra
Mueble 100cm - roble tabaco y blanco · Lavabo cerámico - Modern · Monomando lavabo - Astra

Aluminium



Móvel suspenso 100cm - branco · Lavatório cerâmico 101cm - Left · Monocomando lavatório - Straw · Espelho Timer 100cm c/led
100cm Wall-Mounted Cabinet - White · 101cm Ceramic Washbasin - Left · Single-Lever Washbasin Faucet - Straw · Timer 100cm Mirror with LED
Meuble suspendu 100 cm - blanc · Lavabo céramique 101 cm - Left · Mitigeur lavabo - Straw · Miroir Timer 100 cm avec LED
Mueble suspendido 100cm - blanco · Encimera de lavabo cerámico 101cm - Left · Monomando lavabo - Straw · Espejo Timer 100cm c/led



Móvel 60cm - nut · Lavatório cerâmico 61cm - Modern · Monocomando lavatório - Star · Espelho Aura c/ led
60cm Cabinet - Nut · 61cm Ceramic Washbasin - Modern · Single-Lever Washbasin Faucet - Star · Aura Mirror with LED
Meuble 60 cm - nut · Lavabo céramique 61 cm - Modern · Mitigeur lavabo - Star · Miroir Aura avec LED
Mueble 60cm - nut · Encimera de lavabo cerámico 61cm - Modern · Monomando lavabo - Star · Espejo Aura c/ led

Móvel com pés e lavatório · Vanity with legs and basin
Meuble avec pieds et lavabo · Mueble con pies y lavabo

🕒 45 ⓘ 80 com pés



60cm

--- 205 ---

Branco · White
Blanc · Blanco

735,00 €

Texturas de madeira · Wood textures
Texture du bois · Texturas de madera

735,00 €

Cores · Colors
Couleurs · Colores

815,00 €

RAL

895,00 €



80cm

--- 215 ---

805,00 €

805,00 €

905,00 €

1005,00 €



100cm

--- 225 ---

890,00 €

890,00 €

1000,00 €

1 110,00 €



28x35x120cm

--- 270 ---

520,00 €

520,00 €

600,00 €

680,00 €

Móvel suspenso com lavatório · Wall-mounted vanity with basin
Meuble suspendu avec lavabo · Mueble suspendido con lavabo

🕒 45 ⓘ 40



60cm

--- 200 ---

Branco · White
Blanc · Blanco

620,00 €

Texturas de madeira · Wood textures
Texture du bois · Texturas de madera

620,00 €

Cores · Colors
Couleurs · Colores

700,00 €

RAL

780,00 €



80cm

--- 210 ---

705,00 €

705,00 €

805,00 €

905,00 €



100cm

--- 220 ---

805,00 €

805,00 €

915,00 €

1 025,00 €



120cm

--- 230 ---

980,00 €

980,00 €

1 100,00 €

1 240,00 €

Móvel suspenso com lavatório · Wall-mounted vanity with basin
Meuble suspendu avec lavabo · Mueble suspendido con lavabo

🕒 45 ⓘ 40



80cm

--- 212 ---

Branco · White
Blanc · Blanco

735,00

Texturas de madeira · Wood textures
Texture du bois · Texturas de madera

735,00

Cores · Colors
Couleurs · Colores

835,00

RAL

935,00



100cm

--- 222 ---

890,00 €

890,00 €

1000,00 €

1 110,00 €



80cm

--- 213 ---

735,00

735,00

835,00

935,00



100cm

--- 223 ---

890,00 €

890,00 €

1000,00 €

1 110,00 €



Móvel 60cm - cashmere
Lavatório cerâmico 61cm - Modern
Monocomando lavatório - Plane
Espelho Illusion 60cm

Vanity 60cm - cashmere
 Ceramic washbasin 61cm - Modern
 Single-lever mixer tap - Plane
 Illusion mirror 60cm

Meuble 60cm - cachemire
 Lavabo en céramique 61cm - Modern
 Mitigeur - Plane
 Miroir Illusion 60cm

Mueble 60cm - cashmere
 Encimera de lavabo cerámico 61cm - Modern
 Monomando lavabo - Plane
 Espejo Illusion 60cm

15

Textura de madeira · Wood texture
 Texture du bois · Textura de madera



92 oak	82 cerejo cherry cerisier	88 riga alerce larch mélèze	86 hera	93 nut	83 tabaco tobacco tabac tabaco	84 nogal walnut noyer nogal	89 mocca
------------------	---	--	-------------------	------------------	---	--	--------------------

Estrutura · Structure
 Structure · Estructura



81 preto mate matte black noir mat negro mate	82 ouro mate matte gold or mat oro mate	83 branco mate matte white blanc mat blanco mate
--	--	---

Lacado brilho · Glossy lacquered
 Laqué brillant · Lacado brilho



00 branco white blanc blanco	01 preto black noir negro	02 antracite anthracite anthracite antracita	04 cinzento gray gris gris
---	--	---	---

Lacado mate · Matt lacquered
 Laqué mat · Lacado mate



20 branco white blanc blanco	24 cinzento gray gris gris	25 cashmere	26 castanho brown brun marrón	32 verde oliva olive green vert olive verde oliva	29 azul claro light blue bleu clair azul claro	30 azul blue bleu azul	22 antracite anthracite anthracite antracita	21 preto black noir negro	ral
---	---	-----------------------	--	--	---	---	---	--	-----

móveis

espelhos

torneiras

acessórios
de banho

divisórias

bases e
banheiras

sistemas de
instalação

coleções
sanitárias

espaços
públicos

Copper



Móvel 80cm - branco · Lavatório cerâmico de pousar - Mistic · Monocomando lavatório de encastrar duo - Knobe · Espelho Sunset 80cm
Vanity 80cm - white · Ceramic washbasin - Mistic · Built-in mixer - Knobe duo · Sunset mirror 80cm
Meuble 80cm - blanc · Lavabo en céramique - Mistic · Mitigeur encastré - Knobe duo · Miroir Sunset 80cm
Mueble 80cm - blanco · Lavabo cerâmico sobre encimera - Mistic · Monomando de lavabo mural empotrado duo - Knobe · Espejo Sunset 80cm



Móvel 120cm - branco e cobre · Lavatório cerâmico 121cm - Modern · Monocomando lavatório - Knobe · Espelho Tag 120cm c/led
Vanity 120cm - white and copper · Ceramic washbasin 121cm - Modern · Single lever mixer tap - Knobe · Tag mirror 120cm w/led
Meuble 120cm - blanc y cuivre · Lavabo en céramique 121cm - Modern · Mitigeur - Knobe · Miroir Tag 120cm a/led
Mueble 120cm - blanco y cobre · Encimera de lavabo cerámico 121cm - Modern · Monomando lavabo - Knobe · Espejo Tag 120cm c/led

Móvel com lavatório · Vanity with basin · Meuble avec lavabo · Mueble con lavabo

45 38

**60cm**

81400 _ _ _ _

Branco · White
Blanc · Blanco

405,00 €

Branco / Cobre · White / Copper
Blanc / Cuivre · Blanco / Cobre

445,00 €

Cores · Colors
Couleurs · Colores

485,00 €

Cores / Cobre · Colors / Copper
Couleurs / Cuivre · Colores / Corbre

525,00 €

RAL

565,00 €

RAL / Cobre · RAL / Copper
RAL / Cuivre · RAL / Corbre

605,00 €

**80cm**

81410 _ _ _ _

530,00 €

560,00 €

630,00 €

660,00 €

730,00 €

760,00 €

**100cm**

81420 _ _ _ _

620,00 €

650,00 €

730,00 €

760,00 €

840,00 €

870,00 €

**120cm**

81430 _ _ _ _

780,00 €

805,00 €

910,00 €

935,00 €

1 020,00 €

1 045,00 €

Móvel com tampo · Vanity with countertop · Meuble avec plateau de toilette · Mueble con encimera

45 38

**60cm**

41401 _ _ _ _

Branco · White
Blanc · Blanco

360,00 €

Branco / Cobre · White / Copper
Blanc / Cuivre · Blanco / Cobre

390,00 €

Cores · Colors
Couleurs · Colores

440,00 €

Cores / Cobre · Colors / Copper
Couleurs / Cuivre · Colores / Corbre

470,00 €

RAL

520,00 €

RAL / Cobre · RAL / Copper
RAL / Cuivre · RAL / Corbre

550,00 €

**80cm**

41411 _ _ _ _

460,00 €

490,00 €

560,00 €

590,00 €

660,00 €

690,00 €

**100cm**

41421 _ _ _ _

530,00 €

560,00 €

640,00 €

670,00 €

750,00 €

780,00 €

**120cm**

41431 _ _ _ _

590,00 €

620,00 €

720,00 €

750,00 €

830,00 €

860,00 €

15

Lacado brilho · glossy lacquered
laqué brillant · lacado brilho**00**
branco
white
blanc
blanco**01**
preto
black
noir
negro**02**
antracite
anthracite
antracita**04**
cinzento
gray
gris
gris**12**
cobre
copper
cuivre
cobre

ral



Móvel 100 cm - branco e preto · Lavatório cerâmico 101cm - Modern · Monocomando lavatório - Face · Espelho Join 80cm c/led
Vanity 100 cm - white and black · Ceramic washbasin 101 cm - Modern · Basin mixer tap - Face · Mirror Join 80 cm with led
Mueble 100cm - blanco y negro · Encimera de lavabo cerámico 101cm - Modern · Monomando lavabo - Face · Espejo Join 80cm c/led
Meuble 100 cm - blanc et noir · Lavabo céramique 101 cm - Modern · Mitigeur lavabo - Face · Miroir Join 80 cm avec led

Ark



Móvel 80cm - verde oliva mate · Lavatório cerâmico 81cm - Modern · Monocomando lavatório - Smooth · Espelho Sunny 80cm c/led · Coluna Ark 110cm - verde oliva mate
Vanity 80 cm - matte olive green · Ceramic basin 81 cm - Modern · Basin mixer tap - Smooth · Mirror 80 cm - Sunny with LED · Column unit 110 cm - Ark, matte olive green
Meuble 80 cm - vert olive mat · Lavabo en céramique 81 cm - Modern · Mitigeur lavabo - Smooth · Miroir Sunny 80 cm avec LED · Colonne Ark 110 cm - vert olive mat
Mueble 80cm - verde oliva mate · Encimera de lavabo cerámico 81cm - Modern · Monomando lavabo - Smooth · Espejo Sunny 80cm c/led · columna Ark 110cm - verde oliva mate



Móvel 60cm - branco - Lavatório cerâmico 61cm - Modern - Monocomando lavatório - Type - Espelho Aura c/led
Vanity 60 cm - white - Ceramic basin 61 cm - Modern - Basin mixer tap - Type - Mirror - Aura with LED
Meuble 60 cm - blanc - Lavabo en céramique 61 cm - Modern - Mitigeur lavabo - Type - Miroir Aura avec LED
Mueble 60cm - blanco - Encimera de lavabo cerámico 61cm - Modern - Monomando lavabo - Type - Espejo Aura c/led

móveis

espelhos

torneiras

acessórios
de banho

divisórias

bases e
banheiras

sistemas de
instalação

coleções
sanitárias

espaços
públicos



Móvel com lavatório • Vanity with basin
Meuble avec lavabo • Mueble con lavabo

🕒 45 🕒 50



60cm

81900 _ _ _ _

Branco • White
Blanc • Blanco

530,00 €

Cores • Colors
Couleurs • Colores

610,00 €

RAL

690,00 €



80cm

81910 _ _ _ _

605,00 €

705,00 €

805,00 €



100cm

81920 _ _ _ _

705,00 €

815,00 €

925,00 €



120cm

81930 _ _ _ _

945,00 €

1 065,00 €

1 205,00 €



Coluna • Column
Colonne • Columna

30x35x110cm

abertura esquerda
left opening
ouverture gauche
apertura izquierda

abertura direita
right opening
ouverture à droite
apertura derecha

41971 _ _ _ _

41970 _ _ _ _

460,00 €

540,00 €

620,00 €

15

Lacado brilho • Glossy lacquered
Laqué brillant • Lacado brilho



00
branco
white
blanc
blanco



01
preto
black
noir
negro



02
antracite
anthracite
antracita



04
cinzento
gray
gris
gris



20
branco
white
blanc
blanco



24
cinzento
gray
gris
gris



25
cashmere



26
castanho
brown
brun
marrón



32
verde oliva
olive green
vert olive
verde oliva



29
azul claro
light blue
bleu clair
azul claro



30
azul
blue
bleu
azul



22
antracite
anthracite
antracita



21
preto
black
noir
negro



ral



Móvel 120cm - preto · Lavatório cerâmico 121cm - Modern Duo · Monocomando lavatório - Plane (2x) · Espelho Timer 120cm c/led
Vanity 120 cm - black · Ceramic basin 121 cm - Modern Duo · Basin mixer tap - Plane (2x) · Mirror Timer 120 cm with LED
Meuble 120 cm - noir · Lavabo en céramique 121 cm - Modern Duo · Mítigeur lavabo - Plane (2x) · Miroir Timer 120 cm avec LED
Mueble 120cm - negro · Encimera de lavabo cerámico 121cm - Modern Duo · Monomando lavabo - Plane (x2) · Espejo Timer 120cm c/led

Open



Móvel com profundidade reduzida
Vanity with reduced depth
Meuble avec profondeur réduite
Mueble con profundidad reducida



Móvel 80cm - branco · Lavatório cerâmico 81cm - Short · Monocomando lavatório - Plane · Espelho Join 80cm c/led · Coluna Open 120cm - branco
Vanity 80 cm - white · Ceramic basin 81 cm - Short · Basin mixer tap - Plane · Mirror Join 80 cm with LED · Column Open 120 cm - white
Meuble 80 cm - blanc · Lavabo en céramique 81 cm - Short · Mitigeur lavabo - Plane · Miroir Join 80 cm avec LED · Colonne Open 120 cm - blanc
Mueble 80cm - blanco · Encimera de lavabo cerámico 81cm - Short · Monomando lavabo - Plane · Espejo Join 80cm c/led · Columna Open 120cm - blanco



Móvel 60cm - nut e branco · Lavatório cerâmico 61cm - Short · Monocomando lavatório - Plane · Espelho Timer 60cm c/led · Coluna Open 120 cm - nut e branco
Vanity 60 cm - nut and white · Ceramic basin 61 cm - Short · Basin mixer tap - Plane · Mirror Timer 60 cm with LED · Column Open 120 cm - nut and white
Meuble 60 cm - nut et blanc · Lavabo en céramique 61 cm - Short · Mitigeur lavabo - Plane · Miroir Timer 60 cm avec LED · Colonne Open 120 cm - nut et blanc
Mueble 60cm - nut y blanco · Encimera de lavabo cerámico 61cm - Short · Monomando lavabo - Plane · Espejo Timer 60cm c/led · Columna Open 120cm - nut y blanco



Móvel com profundidade reduzida
Vanity with reduced depth
Meuble avec profondeur réduite
Mueble con profundidad reducida

Móvel com lavatório · Vanity with basin · Meuble avec lavabo · Mueble con lavabo

🕒 39 📏 1 40

	60cm	80cm	100cm	Coluna · Column Colonne · Columna 30x35x140cm
81600 _ _ _ _	81610 _ _ _ _	81620 _ _ _ _	41670 _ _ _ _	
Branco · White Blanc · Blanco	360,00 €	460,00 €	560,00 €	375,00 €
Cores · Colors Couleurs · Colores	440,00 €	560,00 €	670,00 €	455,00 €
Branco / Texturas · White / Textures Blanc / Textures · Blanco / Texturas	360,00 €	460,00 €	560,00 €	375,00 €
Cores / Texturas · Colors / Textures Couleurs / Textures · Colores / Texturas	440,00 €	560,00 €	670,00 €	455,00 €
RAL / Branco · RAL / White RAL / Blanc · RAL / Blanco	520,00 €	660,00 €	800,00 €	535,00 €

STOCK

15

Lacado brilho · Glossy lacquered
Laqué brillant · Lacado brilho



00
branco
white
blanc
bianco



01
preto
black
noir
negro



02
antracite
anthracite
antracita



04
cinzento
gray
gris



ral

Textura de madeira · Wood texture
Texture du bois · Textura de madera



92
oak



82
cerejo
cerез
cherry
cerisier



88
riga
alerce
larch
méleze



86
hera



93
nut



83
tabacco
tobacco
tabac
tabaco



84
nogal
walnut
noyer
nogal



89
mocca



Móvel 100cm - mocca e branco · Lavatório cerâmico 101cm - Short · Monocomando lavatório - Knobe · Espelho Sunset 100cm c/led
Vanity 100 cm - mocca and white · Ceramic basin 101 cm - Short · Basin mixer tap - Knobe · Mirror Sunset 100 cm with LED
Meuble 100 cm - mocca et blanc · Lavabo en céramique 101 cm - Short · Mitigeur lavabo - Knobe · Miroir Sunset 100 cm avec LED
Mueble 100cm - mocca y blanco · Encimera de lavabo cerámico 101cm - Short · Monomando lavabo - Knobe · Espejo Sunset 100cm c/led

Rak



Bancada 60cm - Nogat · Lavatório cerâmico de pousar - Cold · Monocomando lavatório alto - Spirit · Espelho Illusion
Countertop 60 cm - Nogat · Above-counter ceramic basin - Cold · Tall basin mixer tap - Spirit · Mirror Illusion
Plateau 60 cm - Nogat · Lavabo céramique à poser - Cold · Mitigeur lavabo haut - Spirit · Miroir Illusion
Encimera 60cm - Nogat · Lavabo cerámico sobre encimera - Cold · Monomando lavabo alto - Spirit · Espejo Illusion



Bancada 120cm - Nut · Bancada 120cm - branco · Lavatório cerâmico de pousar - Snap · Monocomando lavatório alto - Jazzy · Espelho Join 80cm c/led
Countertop 120 cm - Nut · Countertop 120 cm - white · Above-counter ceramic basin - Snap · Tall basin mixer tap - Jazzy · Mirror Join 80 cm with LED
Plateau 120 cm - Nut · Plateau 120 cm - blanc · Lavabo cerâmique à poser - Snap · Mitigeur lavabo haut - Jazzy · Miroir Join 80 cm avec LED
Encimera 120cm - Nut · Encimera 120cm - blanco · Lavabo cerâmico sobre encimera - Snap · Monomando lavabo alto - Jazzy · Espejo Join 80cm c/led



Bancada · Countertop · Plateau · Encimera

45 ①9

	60cm	80cm	100cm	120cm
Branco · White Blanc · Blanco	42294	42295	42296	42297
Texturas de madeira · Wood textures Texture du bois · Texturas de madera	170,00 €	200,00 €	240,00 €	280,00 €
Cores · Colors Couleurs · Colores	225,00 €	270,00 €	320,00 €	380,00 €
RAL	285,00 €	340,00 €	410,00 €	480,00 €

10

Textura de madeira · Wood texture
Texture du bois · Textura de madera

92 oak	82 cerejo cerез cherry cerisier	88 rīga alerce larch mélèze	86 hera	93 nut	83 tabaco tobacco tabac tabaco	84 nogal walnut noyer nogal	89 mocca

STOCK

15

Lacado brilho · Glossy lacquered
Laqué brillant · Lacado brilho

00 branco white blanc blanco	01 preto black noir negro	02 antracite anthracite anthracite antracita	04 cinzento gray gris gris

Lacado mate · Matt lacquered
Laqué mat · Lacado mate

20 branco white blanc blanco	24 cinzento gray gris gris	25 cashmere	26 castanho brown brun marrón	32 verde oliva olive green vert olive verde oliva	29 azul claro light blue bleu clair azul claro	30 azul blue bleu azul	22 antracite anthracite anthracite antracita	21 preto black noir negro	ral



Lavatório solid surface Silk Right c/ aba 60cm · Bancada Rak - 80cm - mocca · Monocomando lavatório - Straw · Espelho Bow 120cm c/led
 Solid surface basin Silk Right with rim 60 cm · Countertop Rak 80 cm - mocca · Basin mixer tap - Straw · Mirror Bow 120 cm with LED
 Lavabo en solid surface Silk Right avec rebord 60 cm · Plateau Rak 80 cm - mocca · Mitigeur lavabo - Straw · Miroir Bow 120 cm avec LED
 Lavabo solid surface Silk Right c/ reborde 60cm · Encimera Rak 80cm - mocca · Monomando para lavabo - Straw · Espejo Bow 120cm c/led

Pax



Bancada 120cm - branco · Lavatório cerâmico de pousar - Cold · Monocomando lavatório alto - Spirit · Espelho Sunny 120cm c/led
80cm Countertop - Oak · Countertop Ceramic Washbasin - Cold · Built-in Single-Lever Washbasin Faucet - Jazzy · Simple 80cm Mirror
Plateau 80 cm - chêne · Lavabo céramique à poser - Cold · Mitigeur lavabo encastré - Jazzy · Miroir Simple 80 cm
Encimera 120cm - blanco · Lavabo cerâmico sobre encimera - Cold · Monomando lavabo alto - Spirit · Espejo Sunny 120cm c/led



Bancada 80cm - oak · Lavatório cerâmico de pousar - Cold · Monocomando lavatório de encastrar - Jazzy · Espelho Simples 80cm
80cm Countertop - Oak · Countertop Ceramic Washbasin - Cold · Built-in Single-Lever Washbasin Faucet - Jazzy · Simple 80cm Mirror
Plateau 80 cm - chêne · Lavabo céramique à poser - Cold · Mitigeur lavabo encastré - Jazzy · Miroir Simple 80 cm
Encimera 80cm - oak · Lavabo cerâmico sobre encimera - Cold · Monomando lavabo mural empotrado - Jazzy · Espejo Simples 80cm

móveis

espelhos

torneiras

acessórios
de banho

divisórias

bases e
banheiras

sistemas de
instalação

coleções
sanitárias

espaços
públicos

Bancada · Countertop · Plateau · Encimera

⌚ 45 ⌚ 18

	60cm	80cm	100cm	120cm
	55300 _ _ _ _	55302 _ _ _ _	55304 _ _ _ _	55306 _ _ _ _
Branco · White Blanc · Blanco	260,00 €	290,00 €	360,00 €	460,00 €
Texturas de madeira · Wood textures Texture du bois · Texturas de madera	260,00 €	290,00 €	360,00 €	460,00 €
Cores · Colors Couleurs · Colores	340,00 €	390,00 €	470,00 €	590,00 €
RAL	420,00 €	490,00 €	590,00 €	720,00 €

STOCK

15

Lacado brilho · Glossy lacquered
Laqué brillant · Lacado brillo

00
branco
white
blanc
blanco

01
preto
black
noir
negro

02
antracite
anthracite
anthracite
antracita

04
cinzento
gray
gris
gris

ral

10

Textura de madeira · Wood texture
Texture du bois · Textura de madera

92
oak

82
cerejo
cerez
cherry
cerisier

88
riga
alerce
larch
mélèze

86
hera

93
nut

83
tabacco
tobacco
tabac
tabaco

84
nogal
walnut
noyer
nogal

89
mocca



Bancada 100cm - cerezo · Bancada Rak 100cm - branco · Lavatório cerâmico de posar - Mystic · Monocomando lavatório de encastrar - Type duo · Espelho Simples 100cm
Encimera 100cm - cerezo · Encimera Rak - 100cm - blanco · Lavabo cerâmico sobre encimera - Mystic · Monomando de lavabo mural empotrado - Type duo · Espejo Simples 100cm
Countertop 100 cm - cherry · Countertop Rak 100 cm - white · Above-counter ceramic basin - Mystic · Built-in basin mixer tap - Type Duo · Mirror Simples 100 cm
Plateau 100 cm - cerisier · Plateau Rak 100 cm - blanc · Lavabo céramique à poser - Mystic · Mitigeur encastré pour lavabo - Type Duo · Miroir Simples 100 cm

Sado



Móvel 80cm - branco com puxador cromado · Lavatório cerâmico 81cm - Modern · Monocomando lavatório - Plane · Espelho Simples 80cm · Coluna Stance - branco
Vanity 80 cm - white with chrome handle · Ceramic basin 81 cm - Modern · Basin mixer tap - Plane · Simple mirror 80 cm · Column Stance - white
Meuble 80 cm - blanc avec poignée chromé · Lavabo céramique 81 cm - Modern · Mitigeur lavabo - Plane · Miroir Simple 80 cm · Colonne Stance - blanc
Mueble 80cm - blanco con tirador cromo · Encimera de lavabo cerámico 81cm - Modern · Monomando lavabo - Plane · Espejo Simples 80cm · Columna Stance - blanco



Móvel 60cm - azul claro com puxador branco mate · Lavatório cerâmico - Modern · Monocomando lavatório - Keen · Espelho Sunset 80cm · Coluna Stance - azul claro e branco
Vanity 60 cm - light blue with matte white handle · Ceramic basin - Modern · Basin mixer tap - Keen · Mirror Sunset 80 cm · Column Stance - light blue and white
Meuble 60 cm - bleu clair avec poignée blanche mate · Lavabo céramique - Modern · Mitigeur lavabo - Keen · Miroir Sunset 80 cm · Colonne Stance - bleu clair et blanc
Mueble 60cm - azul claro con tirador blanco mate · Lavabo cerámico - Modern · Monomando lavabo - Keen · Espejo Sunset 80cm · Columna Stance azul claro y blanco

Móvel com lavatório · Vanity with basin
Meuble avec lavabo · Mueble con lavabo

🕒 45 📄 50



	60cm __ 600 __	80cm __ 602 __	100cm __ 603 __	CENTRO 120cm __ 604 __	DUPLO 120cm __ 605 __	DUPLO 120cm __ 606 __	Coluna Stance · Column Colonne · Columna 30x40x140cm 57100__ __
Branco · White Blanc · Blanco	390,00 €	430,00 €	505,00 €	660,00 €	700,00 €	780,00 €	57100 __
Texturas de madeira · Wood textures Texture du bois · Texturas de madera	390,00 €	430,00 €	505,00 €	660,00 €	700,00 €	780,00 €	245,00 €
Cores · Colors Couleurs · Colores	475,00 €	530,00 €	615,00 €	780,00 €	830,00 €	910,00 €	330,00 €
RAL	560,00 €	630,00 €	725,00 €	900,00 €	960,00 €	1 040,00 €	430,00 €

Móvel com tampo · Vanity with countertop
Meuble avec plateau de toilette · Mueble con encimera

🕒 45 📄 50



	60cm __ 610 __	80cm __ 612 __	100cm __ 613 __	CENTRO 120cm __ 614 __	DUPLO 120cm __ 615 __	DUPLO 120cm __ 616 __
Branco · White Blanc · Blanco	345,00 €	390,00 €	445,00 €	520,00 €	545,00 €	640,00 €
Texturas de madeira · Wood textures Texture du bois · Texturas de madera	345,00 €	390,00 €	445,00 €	520,00 €	545,00 €	640,00 €
Cores · Colors Couleurs · Colores	455,00 €	510,00 €	575,00 €	680,00 €	670,00 €	790,00 €
RAL	545,00 €	630,00 €	690,00 €	810,00 €	805,00 €	920,00 €

STOCK

15

Lacado brilho · Glossy lacquered
Laqué brillant · Lacado brilho



00 branco
white
blanc
blanco

01 preto
black
noir
negro

02 antracite
anthracite
anthracite
antracita

04 cinzento
gray
gris
gris

Lacado mate · Matt lacquered
Laqué mat · Lacado mate



20 branco
white
blanc
blanco

24 cinzento
gray
gris
gris

25 cashmere

26 castanho
brown
brun
marrón

32 verde oliva
olive green
vert olive
verde oliva

29 azul claro
light blue
bleu clair
azul claro

30 azul
blue
bleu
azul

22 antracite
anthracite
anthracite
antracita

21 preto
black
noir
negro

ral

15

Textura de madeira · Wood texture
Texture du bois · Textura de madera

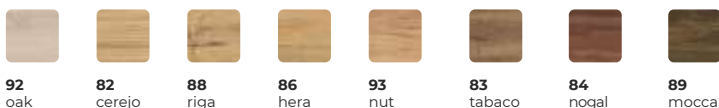

92 oak

82 cerejo
cherry
cerisier

88 riga
alerce
larch
mélèze

86 hera

93 nut

83 tabaco
tobacco
tabac
tabaco

84 nogal
walnut
noyer
nogal

89 mocca

Kit puxadores · Handles kit
Kit poignées · Kit manijas



70 cromado
chrome
chromé
cromo

72 preto mate
matte black
noir mat
negro mate

73 branco mate
matte white
blanc mat
blanco mate

71 ouro mate
matte gold
or mat
oro mate

Os puxadores estão incluídos.
The handles are included.
Les poignées sont incluses.
Las manijas están incluidas.



Móvel 120cm - castanho e riga · Lavatório cerâmico de pousar - Snap · Monocomando - Knobe · Espelho Lista 100cm - riga
Vanity 120 cm - brown and riga · Above-counter ceramic basin - Snap · Mixer tap - Knobe · Mirror Lista 100 cm - riga
Meuble 120 cm - marron et riga · Lavabo céramique à poser - Snap · Mitigeur - Knobe · Miroir Lista 100 cm - riga
Mueble 120cm - marrón y riga · Lavabo cerámico sobre encimera- Snap · Monomando - Knobe · Espejo Lista 100cm - riga

Sado modular



Modulo prateleira 20cm
Shelf module
Module étagère
Módulo estante



Modulo prateleira 40cm
Shelf module
Module étagère
Módulo estante



Modulo porta 20cm
Module door
Module porte
Mueble puerta



Módulo porta 40cm
Module door
Module porte
Módulo puerta



Móvel 60 / 70 / 80 / 100
Vanity
Meuble
Mueble



Módulo tulha 40cm
Tulip module
Module tulipe
Módulo cesto



Tampo 60, 80, 100, 120, 130, 140, 160, 170, 180cm
Countertop
Plateau
Encimera





Móvel 180cm (20+60+20+60+20cm) - branco e tabaco · Lavatório solid surface Silk Duo · Monocomando lavatório - Spirit (2x) · Espelho Join (2x) 60cm c/led
 Vanity 180 cm (20+60+20+60+20 cm) - white and tobacco · Solid surface basin Silk Duo · Basin mixer tap - Spirit (2x) · Mirror Join (2x) 60 cm with LED
 Meuble 180 cm (20+60+20+60+20 cm) - blanc et tabac · Lavabo solid surface Silk Duo · Mitigeur lavabo - Spirit (2x) · Miroir Join (2x) 60 cm avec LED
 Mueble 180cm (20+60+20+60+20cm) - blanco y tabaco · Lavabo solid surface Silk DUo · Monomando lavabo - Spirit (2x) · Espejo Join (2x) 60cm c/led

Móvel · Vanity · Meuble · Mueble

⌚ 45 ⓘ 50

60cm -- 620 --	80cm -- 621 --	100cm -- 622 --	CENTRO 120cm -- 623 --	DUPLO 120cm -- 624 --	DUPLO 120cm -- 625 --
Branco · White Blanc · Blanco	300,00 €	330,00 €	360,00 €	430,00 €	460,00 €
Texturas de madeira · Wood textures Texture du bois · Texturas de madera	300,00 €	330,00 €	360,00 €	430,00 €	460,00 €
Cores · Colors Couleurs · Colores	385,00 €	430,00 €	470,00 €	560,00 €	560,00 €
RAL	470,00 €	530,00 €	580,00 €	590,00 €	690,00 €

Módulos · Module · Module · Módulos

⌚ 45 ⓘ 50

Prateleira · Shelf Étagère · Balda	Prateleira · Shelf Étagère · Balda	Porta · Door Porte · Puerta	Porta · Door Porte · Puerta	Tulha · Tulip Tulipe · Cesto
20cm 55033	40cm 55034	20cm -- 630 --	40cm -- 631 --	40cm -- 632 --
Branco · White Blanc · Blanco	130,00 €	155,00 €	185,00 €	245,00 €
Texturas de madeira · Wood textures Texture du bois · Texturas de madera	130,00 €	155,00 €	185,00 €	245,00 €
Cores · Colors Couleurs · Colores	185,00 €	215,00 €	240,00 €	315,00 €
RAL	240,00 €	270,00 €	300,00 €	375,00 €

Tampo · Countertop · Plateau · Encimera

	60cm 57060	80cm 57080	100cm 570100	120cm 570120	140cm 570140	160cm 570160	180cm 570180
Branco · White Blanc · Blanco	65,00 €	80,00 €	90,00 €	100,00 €	125,00 €	150,00 €	170,00 €
Texturas de madeira · Wood textures Texture du bois · Texturas de madera	65,00 €	80,00 €	90,00 €	100,00 €	125,00 €	150,00 €	170,00 €
Cores · Colors Couleurs · Colores	105,00 €	115,00 €	135,00 €	150,00 €	170,00 €	205,00 €	230,00 €
RAL	135,00 €	150,00 €	185,00 €	195,00 €	220,00 €	265,00 €	290,00 €

15

Textura de madeira · Wood texture
Texture du bois · Textura de madera

92 oak	82 cerejo cerез cherry cerisier	88 riga alerce larch mélèze	86 hera	93 nut	83 tabaco tobacco tabac tabaco	84 nogal walnut noyer nogal	89 mocca
------------------	--	--	-------------------	------------------	---	--	--------------------

Kit puxadores · Handles kit
Kit poignées · Kit manijas

70 cromado chrome chromé cromo	72 preto mate matte black noir mat negro mate	73 branco mate matte white blanc mat blanco mate	71 ouro mate matte gold or mat oro mate
---	--	---	--

Os puxadores estão incluídos.
The handles are included.
Les poignées sont incluses.
Las manijas están incluidas.

Lacado brilho · Glossy lacquered
Laqué brillant · Lacado brilho

00 branco white blanc blanco	01 preto black noir negro	02 antracite anthracite anthracita	04 cinzento gray gris gris
---	--	--	---

Lacado mate · Matt lacquered
Laqué mat · Lacado mate

20 branco white blanc blanco	24 cinzento gray gris gris	25 cashmere	26 castanho brown brun marrón	32 verde oliva olive green vert olive verde oliva	29 azul claro light blue bleu clair azul claro	30 azul blue bleu azul	22 antracite anthracite anthracita	21 preto black noir negro
---	---	-----------------------	--	--	---	---	--	--



ral



Móvel 120cm (40+60+20cm) - cinzento · Lavatório cerâmico de pousar - Tundra · Monocomando lavatório - Keen duo · Espelho Luna 80cm
 Vanity 120 cm (40+60+20 cm) – gray · Countertop ceramic basin – Tundra · Basin mixer tap – Keen duo · Mirror Luna 80 cm
 Meuble 120 cm (40+60+20 cm) – gris · Lavabo en céramique à poser – Tundra · Mitigeur lavabo – Keen duo · Miroir Luna 80 cm
 Mueble 120cm (40+60+20cm) - gris · Lavabo cerâmico sobre encimera - Tundra · Monomando lavabo - Keen duo · Espejo Luna 80cm

Rustik



Móvel 60cm - cinzento · Lavatório cerâmico de pousar - Nevada · Monocomando lavatório alto · Type · Espelho Luna 60cm
Vanity 60cm - gray · Countertop ceramic basin - Nevada · Tall basin mixer tap · Type · Mirror Luna 60cm
Meuble 60cm - gris · Lavabo en céramique à poser - Nevada · Mitigeur lavabo haut · Type · Miroir Luna 60cm
Mueble 60cm - gris · Lavabo cerámico sobre encimera - Nevada · Monomando lavabo alto · Type · Espejo Luna 60cm



Móvel 120cm - tabaco · Lavatório solid surface de posar - Nevada · Monocomando lavatório alto - Spirit · Espelho Aura c/led
Vanity 120cm - tabaco · Countertop ceramic basin - Nevada · Tall basin mixer tap - Spirit · Mirror Aura w/led
Meuble 120cm - tabaco · Lavabo en céramique à poser - Nevada · Mitigeur lavabo haut - Spirit · Moroir Aura a/led
Mueble 120cm - tabaco · Lavabo solid surface sobre encimera - Nevada · Monomando lavabo alto- Spirit · Espejo Aura c/led



Móvel 80cm - mocca
Lavatório cerâmico de pousar - Melt
Monocomando lavatório encastrar duo - Keen
Espelho Join 80cm

Vanity 80 cm – mocca
 Countertop ceramic basin – Melt
 Built-in basin mixer tap duo – Keen
 Mirror Join 80 cm

Mueble 80cm - mocca
 Lavabo cerámico sobre encimera - Melt
 Monomando lavabo empotrar duo - Keen
 Espejo Join 80cm

Meuble 80 cm – mocca
 Lavabo en céramique à poser – Melt
 Mitigeur encastré duo pour lavabo – Keen
 Miroir Join 80 cm

Móvel · Vanity · Meuble · Mueble

🕒 45 ⓘ 70

	60cm	80cm	100cm	120cm
	42200	42210	42220	42230
Branco · White Blanc · Blanco	490,00	560,00	630,00	705,00
Texturas de madeira · Wood textures Texture du bois · Texturas de madera	490,00	560,00	630,00	705,00
Cores · Colors Couleurs · Colores	570,00	660,00	740,00	825,00
RAL	650,00	760,00	850,00	945,00

15

Textura de madeira · Wood texture
 Texture du bois · Textura de madera

92 oak	82 cerejo cerez cherry cerisier	88 riga alerce larch mélèze	86 hera	93 nut	83 tabaco tobacco tabac tabaco	84 nogal walnut noyer nogal	89 mocca

Lacado mate · Matt lacquered
 Laqué mat · Lacado mate

20 branco white blanc blanco	24 cinzento gray gris gris	25 cashmere	26 castanho brown brun marrón	32 verde oliva olive green vert olive verde oliva	29 azul claro light blue bleu clair azul claro	30 azul blue bleu azul	22 antracite anthracite anthracite antracita	21 preto black noir negro	ral



Móvel 100cm - nogal · Lavatório solid surface de posar - Alba · Monocomando lavatório alto - Smooth · Espelho Alva 80x100
Vanity 100 cm - walnut · Countertop solid surface basin - Alba · Tall basin mixer tap - Smooth · Mirror Alva 80x100
Meuble 100 cm - noyer · Lavabo solid surface à poser - Alba · Mitigeur haut pour lavabo - Smooth · Miroir Alva 80x100
Mueble 100cm - nogal · Lavabo solid surface sobre encimera - Alba · Monomando lavabo alto - Smooth · Espejo Alva 80x100

Anchor



Móvel com profundidade reduzida
Vanity with reduced depth
Meuble avec profondeur réduite
Mueble con profundidad reducida



Móvel 60cm - branco · Lavatório Flat 61cm · Monocomando lavatório - Plane · Espelho Liso 60cm
Vanity 60 cm - white · Flat basin 61 cm · Basin mixer tap - Plane · Mirror Liso 60 cm
Meuble 60 cm - blanc · Lavabo Flat 61 cm · Mitigeur lavabo - Plane · Miroir Liso 60 cm
Mueble 60cm - blanco · Lavamanos Flat 61cm · Monomando para lavamanos - Plane · Espejo Liso 60cm



Móvel 60cm - branco e carvalho tabaco · Lavatório cerâmico 61cm - Flat · Monocomando lavatório - Jazzy · Espelho Sunset 80cm c/led · Coluna Stance - branco e carvalho tabaco
Möbel 60cm - blanc et chêne tabac · Lavatoire en céramique 61cm - Flat · Mitigeur lavabo - Jazzy · Miroir Sunset 80 cm avec LED · Colonne Stance - blanc et chêne tabac
Mueble 60cm - blanco y roble tabaco · Encimera de lavabo cerámico 61cm - Flat · Monomando lavabo - Jazzy · Espejo Sunset 80cm c/led · Clumna a Stance - blanco y roble tabaco



Móvel suspenso com lavatório · Vanity with basin
Meuble avec lavabo · Mueble suspendido con lavabo

Coluna Stance · Column
Colonne · Columna

⊙ 36 ⓘ 50



60cm

82802 _ _ _ _

Branco · White
Blanc · Blanco

265,00 €

Hera / Branco · Hera / White
Hera / Blanc · Hera / Blanco

265,00 €

Nogal / Branco · Walnut / White
Noyer / Blanc · Noga / Blanco

265,00 €



80cm

82804 _ _ _ _

335,00 €

335,00 €

335,00 €



30x40x140cm

57100 _ _

245,00 €

245,00 €

245,00 €

STOCK

Acabamentos · Finishes
Finitions · Acabados



00
branco
white
blanc
blanco



86
hera/branco
hera/white
hera/blanc
hera/blanco



84
nogal/branco
walnut/white
noyer/blanc
nogal/blanco



Móvel 80cm - nogal e branco · Lavatório cerâmico 81cm - Flat · Monocomando lavatório - Spirit · Espelho Join 80cm c/led
Vanity 80 cm - walnut and white · Ceramic basin 81 cm - Flat · Basin mixer tap - Spirit · Mirror Join 80 cm with LED
Meuble 80 cm - noyer et blanc · Lavabo en céramique 81 cm - Flat · Mitigeur lavabo - Spirit · Miroir Join 80 cm avec LED
Mueble 80cm - nogal y blanco · Encimera de lavabo cerámico 81cm - Flat · Monomando lavabo - Spirit · Espejo Join 80cm c/led

Spot



Móvel 100cm - Branco · Lavatório cerâmico de pousar - Nevada · Monocomando lavatório alto - Keen · Espelho 60x100cm - Alva · Coluna Teen - Branco
Vanity 100cm - White · Ceramic countertop washbasin - Nevada · Tall single lever basin mixer - Keen · Mirror 60x100cm - Alva · Column Teen - White
Mueble 100cm - Blanc · Vasque à poser en céramique - Nevada · Mitigeur monocommande lavabo haut - Keen · Miroir 60x100cm - Alva · Colonne Teen - Blanc
Mueble 100cm - Blanco · Lavabo cerâmico sobre encimera - Nevada · Monomando lavabo alto - Keen · Espejo 60x100cm - Alva · Columna Teen - Blanco



Móvel 80cm - Nut · Lavatório cerâmico 81cm - Modern · Monocomando lavatório - Keen · Espelho 60x70cm - Luna
Vanity 80cm - Nut · Ceramic washbasin 81cm - Modern · Single lever basin mixer - Keen · Mirror 60x70cm - Luna
Mueble 80cm - Nut · Lavabo céramique 81cm - Modern · Mitigeur monocommande lavabo - Keen · Mirroir 60x70cm - Luna
Mueble 80cm - Nut · Encimera de lavabo cerâmico 81cm - Modern · Monomando lavabo - Keen · Espejo 60x70cm - Luna



Móvel com lavatório · Vanity w/ washbasin
Meuble a/ lavabo · Mueble con lavabo

Móvel com tampo · With vanity top
Meuble avec plateau · Mueble con encimera

Coluna Teen · Column
Colonne · Columna

🕒 45 📦 35

	60cm	80cm	100cm	60cm	80cm	100cm	30x30x140cm
	200	201	202	205	206	207	299
Branco · White Blanc · Blanco	190,00 €	220,00 €	260,00 €	190,00 €	220,00 €	260,00 €	200,00 €
Hera · Nogueira	190,00 €	220,00 €	260,00 €	190,00 €	220,00 €	260,00 €	200,00 €
	24	12	12	24	12	12	12

STOCK

Acabamentos · Finishes
Finitions · Acabados



00
branco
white
blanc
blanco



86
hera



84
nogal
walnut
noyer
nogal

Kit puxadores · Handles kit
Kit poignées · Kit manijas



74
aço inox
stainless steel
acier inoxydable
acero inoxidable



72
preto mate
matte black
noir mat
negro mate



75
ouro escovado
brushed gold
or brossé
oro cepillado



Móvel 60cm - Hera · Lavatório cerâmico 61cm - Modern · Monocomando lavatório - Jazzy · Espelho ø60cm - Aria · Coluna Teen - Hera
Vanity 60cm - Hera · Ceramic washbasin 61cm - Modern · Single lever basin mixer - Jazzy · Mirror ø60cm - Aria · Column Teen - Hera
Mueble 60cm - Hera · Lavabo cerámico 61cm - Modern · Mitigeur monocommande lavabo - Jazzy · Mirroir ø60cm - Aria · Colonne Teen - Hera
Mueble 60cm - Hera · Encimera de lavabo cerámico 61cm - Modern · Monomando lavabo - Jazzy · Espejo ø60cm - Aria · Columna Teen - Hera

Twice



Móvel 80cm - Branco · Lavatório cerâmico de pousar - Cold · Monocomando lavatório alto - Spirit · Espelho 80x70cm - Sunny · Coluna Teen - Branco
Vanity 80cm - White · Ceramic countertop washbasin - Cold · Tall single lever basin mixer - Spirit · Mirror 80x70cm - Sunny · Column Teen - White
Mueble 80cm - Blanc · Vasque à poser en céramique - Cold · Mitigeur monocommande lavabo haut - Spirit · Mirroir 80x70cm - Sunny · Colonne Teen - Blanc
Mueble 80cm - Blanco · Lavabo cerámico sobre encimera - Cold · Monomando lavabo alto - Spirit · Espejo 80x70cm - Sunny · Columna Teen - Blanco



Móvel 60cm - Riga · Lavatório cerâmico 61cm - Modern · Monocomando lavatório - Keen · Espelho 60x75cm Lista - Riga
Vanity 60cm - Riga · Ceramic washbasin 61cm - Modern · Single lever basin mixer - Keen · Mirror 60x75cm Lista - Riga
Mueble 60cm - Riga · Lavabo cerâmique 61cm - Modern · Mitigeur monocommande lavabo - Keen · Mirroir 60x75cm Lista - Riga
Mueble 60cm - Riga · Encimera de lavabo cerâmico 61cm - Modern · Monomando lavabo - Keen · Espejo 60x75cm Lista - Riga



Móvel com lavatório · Vanity w/ washbasin
Meuble a/ lavabo · Mueble con lavabo

Móvel com tampo · With vanity top
Meuble avec plateau · Mueble con encimera

Coluna Teen · Column
Colonne · Columna

🕒 45 🕒 50



60cm

80cm

100cm

--- 220 ---

--- 221 ---

--- 222 ---

Branco · White
Blanc · Bianco

240,00 €

280,00 €

335,00 €

Hera · Nogueira

240,00 €

280,00 €

335,00 €



16

8

8



60cm

80cm

100cm

--- 225 ---

--- 226 ---

--- 227 ---

240,00 €

280,00 €

335,00 €

240,00 €

280,00 €

335,00 €

16

8

8



30x30x140cm

--- 299 ---

200,00 €

200,00 €

12

STOCK

Acabamentos · Finishes
Finitions · Acabados



00
branco
white
blanc
blanco



86
hera



84
nogal
walnut
noyer
nogal



74
aço inox
stainless steel
acier inoxydable
acero inoxidable



72
preto mate
matte black
noir mat
negro mate



75
ouro escovado
brushed gold
or brossé
oro cepillado



Móvel 100cm - Nogueira - Lavatório cerâmico 101cm - Modern - Monocomando lavatório - Spirit - Espelho 100x70cm - Luna - Toalheiro de pousar
Vanity 100cm - Walnut - Ceramic washbasin 101cm - Modern - Single lever basin mixer - spirit - Mirror 100x70cm - Luna - Countertop towel rack
Mueble 100cm - Noyer - Lavabo cerâmico 101cm - Modern - Mitigeur monocommande lavabo - Spirit - Mirroir 100x70cm - Luna - Porte-serviettes à poser
Mueble 100cm - Nogueira - Encimera de lavabo cerâmico 101cm - Modern - Monomando lavabo - Spirit - Espejo 100x70cm - Luna - Toallero de apoyo

móveis

espelhos

torneiras

acessórios
de banho

divisórias

bases e
banheiras

sistemas de
instalação

coleções
sanitárias

espaços
públicos

Nexus



Móvel 80cm - Tabaco · Lavatório cerâmico 81cm - Modern · Monocomando lavatório - Knobe · Espelho 80x70cm - Sunny · Toalheiro auto-adesivo
Vanity 80cm - Tabaco · Ceramic washbasin 81cm - Modern · Single lever basin mixer - Knobe · Mirror 80x70cm - Sunny · Self-adhesive towel rack
Mueble 80cm - Tabaco · Lavabo cerâmico 81cm - Modern · Mitigeur monocommande lavabo - Knobe · Mirroir 80x70cm - Sunny · Porte-serviettes autocollant
Mueble 80cm - Tabaco · Encimera de lavabo cerâmico 81cm - Modern · Monomando lavabo - Knobe · Espejo 80x70cm - Sunny · Toallero autoadhesivo



« Nexus »

Móvel 100cm - Hera · Lavatório cerâmico 101cm - Modern · Monocomando lavatório - Spirit · Espelho 100x70cm - Luna
Vanity 100cm - Hera · Ceramic washbasin 101cm - Modern · Single lever basin mixer - Spirit · Mirror 100x70cm - Luna
Mueble 100cm - Hera · Lavabo céramique 101cm - Modern · Mitigeur monocommande lavabo - Spirit · Mirroir 100x70cm - Luna
Mueble 100cm - Hera · Encimera de lavabo cerámico 101cm - Modern · Monomando lavabo - Spirit · Espejo 100x70cm - Luna



Móvel com lavatório · Vanity w/ washbasin
Meuble a/ lavabo · Mueble con lavabo

Coluna Teen · Column
Colonne · Columna

⌚ 60 ⌚ 70



60cm

--- 230 ---

Branco · White
Blanc · Blanco

320,00 €

Hera · Nogal

320,00 €



12



80cm

--- 231 ---

360,00 €

360,00 €

6



100cm

--- 232 ---

430,00 €

430,00 €

6



30x30x140cm

--- 299 ---

200,00 €

200,00 €

12

STOCK

Acabamentos · Finishes
Finitions · Acabados



00
branco
white
blanc
blanco



86
hera



84
nogal
walnut
noyer
nogal



74
aço inox
stainless steel
acier inoxydable
acero inoxidable



72
preto mate
matte black
noir mat
negro mate



75
ouro escovado
brushed gold
or brossé
oro cepillado



Móvel 60cm - Branco · Lavatório cerâmico 61cm - Modern · Monocomando lavatório - Keen · Espelho 60x70cm - Luna · Coluna Teen - Branco
Vanity 60cm - White · Ceramic washbasin 61cm - Modern · Single lever basin mixer - Keen · Mirror 60x70cm - Luna · Column Teen - White
Mueble 60cm - Blanc · Lavabo cerâmico 61cm - Modern · Mitigeur monocommande lavabo - Keen · Mirroir 60x70cm - Luna · Colonne Teen - Blanc
Mueble 60cm - Blanco · Encimera de lavabo cerâmico 61cm - Modern · Monomando lavabo - Keen · Espejo 60x70cm - Luna · Columna Teen - Blanco

móveis

espelhos

torneiras

acessórios
de banho

divisórias

bases e
banheiras

sistemas de
instalação

coleções
sanitárias

espaços
públicos

Deko



Móvel 80cm - Branco · Lavatório cerâmico 81cm - Modern · Monocomando lavatório - Plane · Espelho 80x70cm - Sunny · Coluna Teen - Branco
Vanity 80cm - White · Ceramic washbasin 81cm - Modern · Single lever basin mixer - Plane · Mirror 80x70cm - Sunny · Column Teen - White
Mueble 80cm - Blanc · Lavabo cerâmico 81cm - Modern · Mitigeur monocommande lavabo - Plane · Miroir 80x70cm - Sunny · Colonne Teen - Blanc
Mueble 80cm - Blanco · Encimera de lavabo cerámico 81cm - Modern · Monomando lavabo - Plane · Espejo 80x70cm - Sunny · Columna Teen - Blanco



Móvel 60cm - Nogueira - Lavatório cerâmico 61cm - Modern - Monocomando lavatório - Knobê - Espelho 60x70cm - Luna
Vanity 60cm - Walnut - Ceramic washbasin 61cm - Modern - Single lever basin mixer - Knobê - Mirror 60x70cm - Luna
Mueble 60cm - Noyer - Lavabo cerâmico 61cm - Modern - Mitigeur monocommande lavabo - Knobê - Mirróir 60x70cm - Luna
Mueble 60cm - Nogueira - Encimera de lavabo cerâmico 61cm - Modern - Monomando lavabo - Knobê - Espejo 60x70cm - Luna



Móvel com lavatório · Vanity w/ washbasin
Meuble a/ lavabo · Mueble con lavabo

Coluna Teen · Column
Colonne · Columna

⌚ 45 ⓘ 70



60cm

--- 260 ---

Branco · White
Blanc · Blanco

255,00 €

Hera · Nogal

255,00 €



12



80cm

--- 261 ---

300,00 €

300,00 €

6



100cm

--- 262 ---

370,00 €

370,00 €

6



30x30x140cm

--- 299 ---

200,00 €

200,00 €

12



Acabamentos · Finishes
Finitions · Acabados



00
branco
white
blanc
blanco



86
hera



84
nogal
walnut
noyer
nogal



74
aço inox
stainless steel
acier inoxydable
acero inoxidable



72
preto mate
matte black
noir mat
negro mate



75
ouro escovado
brushed gold
or brossé
oro cepillado



Móvel 100cm - Hera · Lavatório cerâmico 101cm - Modern · Monocomando lavatório - Type · Espelho 100x70cm - Luna
Vanity 100cm - Hera · Ceramic washbasin 101cm - Modern · Single lever basin mixer - Type · Mirror 100x70cm - Luna
Mueble 100cm - Hera · Lavabo céramique 101cm - Modern · Mitigeur monocommande lavabo - Type · Mirroir 100x70cm - Luna
Mueble 100cm - Hera · Encimera de lavabo cerâmico 101cm - Modern · Monomando lavabo - Type · Espejo 100x70cm - Luna

Raki



Móvel 100cm - Nogueira - Lavatório cerâmico 101cm - Modern - Monocomando lavatório - Knobe - Espelho 100x70cm - Luna
Vanity 100cm - Walnut - Ceramic washbasin 101cm - Modern - Single lever basin mixer - Knobe - Mirror 100x70cm - Luna
Mueble 100cm - Noyer - Lavabo cerâmico 101cm - Modern - Mitigeur monocommande lavabo - Knobe - Mirroir 60x70cm - Luna
Mueble 100cm - Nogueira - Encimera de lavabo cerâmico 101cm - Modern - Monomando lavabo - Knobe - Espejo 60x70cm - Luna



Móvel 60cm - Nut · Lavatório cerâmico 61cm - Modern · Monocomando lavatório - Plane · Espelho 60x75cm - Lista Nut · Coluna Teen - Nut
Vanity 60cm - Nut · Ceramic washbasin 61cm - Modern · Single lever basin mixer - Plane · Mirror 60x75cm - Lista Nut · Column Teen - Nut
Mueble 60cm - Nut · Lavabo cerámique 61cm - Modern · Mitigeur monocommande lavabo - Plane · Mirroir 60x75cm - Lista Nut · Colonne Teen - Nut
Mueble 60cm - Nut · Encimera de lavabo cerámico 61cm - Modern · Monomando lavabo - Plane · Espejo 60x75cm - Lista Nut · Columna Teen - Nut



Móvel com lavatório · Vanity w/ washbasin
Meuble a/ lavabo · Mueble con lavabo

Coluna Teen · Column
Colonne · Columna

⌚ 45 ⓘ 70



60cm

--- 240 ---



80cm

--- 241 ---



100cm

--- 242 ---



30x30x140cm

--- 299 ---

Branco · White
Blanc · Blanco

255,00 €

282,00 €

375,00 €

200,00 €

Hera · Nogal

255,00 €

282,00 €

375,00 €

200,00 €



12

6

6

12

STOCK

Acabamentos · Finishes
Finitions · Acabados



00
branco
white
blanc
blanco



86
hera



84
nogal
walnut
noyer
nogal

Kit puxadores · Handles kit
Kit poignées · Kit manijas



74
aço inox
stainless steel
acier inoxydable
acero inoxidable



72
preto mate
matte black
noir mat
negro mate



75
ouro escovado
brushed gold
or brossé
oro cepillado



Móvel 80cm - Branco · Lavatório cerâmico 81cm - Modern · Monocomando lavatório - Knobe · Espelho 80x60cm - Koper
Vanity 80cm - White · Ceramic washbasin 81cm - Modern · Single lever basin mixer - Knobe · Mirror 80x60cm - Koper
Mueble 80cm - Blanc · Lavabo céramique 81cm - Modern · Mitigeur monocommande lavabo - Knobe · Mirroir 80x60cm - Koper
Mueble 80cm - Blanco · Encimera de lavabo cerámico 81cm - Modern · Monomando lavabo - Knobe · Espejo 80x60cm - Koper



Móvel 60cm - Nogal · Lavatório cerâmico 61cm - Modern · Monocomando lavatório - Knobe · Espelho ø80cm - Aria
Vanity 60cm - Nogal · Ceramic washbasin 61cm - Modern · Single lever basin mixer - Knobe · Mirror ø80cm - Aria
Mueble 60cm - Nogal · Lavabo céramique 61cm - Modern · Mitigeur monocommande lavabo - Knobe · Mirroir ø80cm - Aria
Mueble 60cm - Nogal · Encimera de lavabo cerámico 61cm - Modern · Monomando lavabo - Knobe · Espejo ø80cm - Aria



Móvel 80cm - Branco · Lavatório cerâmico 81cm - Modern · Monocomando lavatório - Spirit · Espelho ø80cm - Aria
Vanity 80cm - White · Ceramic washbasin 81cm - Modern · Single lever basin mixer - Spirit · Mirror ø80cm - Aria Mueble 80cm - Blanc · Lavabo céramique 81cm -
Modern · Mitigeur monocommande lavabo - Spirit · Mirroir ø80cm - Aria
Mueble 80cm - Blanco · Encimera de lavabo cerâmico 81cm - Modern · Monomando lavabo - Spirit · Espejo ø80cm - Aria

Profundidade reduzida

Reduced depth
Profondeur réduite
Profundidad reducida

36 cm



Móvel com lavatório · Vanity w/ washbasin
Meuble a/ lavabo · Mueble con lavabo

Coluna Teen · Column
Colonne · Columna

🕒 35 🕒 70



60cm

--- 270 ---



80cm

--- 271 ---



30x30x140cm

--- 299 ---

Branco · White
Blanc · Blanco

275,00 €

320,00 €

200,00 €

Hera · Nogal

275,00 €

320,00 €

200,00 €



18

9

12

STOCK

Acabamentos · Finishes
Finitions · Acabados



00
branco
white
blanc
blanco



86
herá



84
nogal
walnut
noyer
nogal



74
aço inox
stainless steel
acier inoxydable
acero inoxidable



72
preto mate
matte black
noir mat
negro mate



75
ouro escovado
brushed gold
or brossé
oro cepillado



Móvel 60cm - Hera · Lavatório cerâmico 61cm - Modern · Monocomando lavatório - Knobe · Espelho 60x70cm - Sunny · Toalheiro auto-adesivo
Vanity 60cm - Hera · Ceramic washbasin 61cm - Modern · Single lever basin mixer - Knobe · Mirror 60x70cm - Sunny · Self-adhesive towel rack
Mueble 60cm - Hera · Lavabo céramique 61cm - Modern · Mitigeur monocommande lavabo - Knobe · Mirroir 60x70cm - Sunny · Porte-serviettes autocollant
Mueble 60cm - Hera · Encimera de lavabo cerâmico 61cm - Modern · Monomando lavabo - Knobe · Espejo 60x70cm - Sunny · Toallero auadhesivo

Ryo



Móvel 60cm - Hera · Lavatório cerâmico 61cm - Modern · Monocomando lavatório - Plane · Espelho 60x75cm - Lista Hera
Vanity 60cm - Hera · Ceramic washbasin 61cm - Modern · Single lever basin mixer - Plane · Mirror 60x75cm - Lista Hera
Mueble 60cm - Hera · Lavabo céramique 61cm - Modern · Mitigeur monocommande lavabo - Plane · Mirroir 60x75cm - Lista Hera
Mueble 60cm - Hera · Encimera de lavabo cerámico 61cm - Modern · Monomando lavabo - Plane · Espejo 60x75cm - Lista Hera



Móvel 80cm - Cerejo - Lavatório cerâmico 81cm - Modern - Monocomando lavatório - Keen - Espelho ø80cm - Aria - Coluna Teen - Cerejo
Vanity 80cm - Cerejo - Ceramic washbasin 81cm - Modern - Single lever basin mixer - Keen - Mirror ø80cm - Aria - Column Teen - Cerejo
Mueble 80cm - Cerejo - Lavabo cerámico 81cm - Modern - Mitigeur monocommande lavabo - Keen - Mirroir ø80cm - Aria - Colonne Teen - Cerejo
Mueble 80cm - Cerejo - Encimera de lavabo cerámico 81cm - Modern - Monómando lavabo - Keen - Espejo ø80cm - Aria - Columna Teen - Cerejo

móveis

espelhos

torneiras

acessórios
de banho

divisórias

bases e
banheiras

sistemas de
instalação

coleções
sanitárias

espaços
públicos



Móvel com lavatório · Vanity w/ washbasin
Meuble a/ lavabo · Mueble con lavabo

Coluna Teen · Column
Colonne · Columna

⌚ 45 ⓘ 70



60cm

--- 250 ---



80cm

--- 251 ---



100cm

--- 252 ---



30x30x140cm

--- 299 ---

Branco · White
Blanc · Blanco

225,00 €

266,00 €

345,00 €

200,00 €

Hera · Nogal

225,00 €

266,00 €

345,00 €

200,00 €



12

6

6

12

STOCK

Acabamentos · Finishes
Finitions · Acabados



00
branco
white
blanc
blanco



86
hera



84
nogal
walnut
noyer
nogal



74
aço inox
stainless steel
acier inoxydable
acero inoxidable



72
preto mate
matte black
noir mat
negro mate



75
ouro escovado
brushed gold
or brossé
oro cepillado



Móvel 100cm - Branco - Lavatório 101cm - Modern - Monocomando lavatório - Spirit - Espelho 100x70cm - Luna
Vanity 100cm - White - Ceramic washbasin 101cm - Modern - Single lever basin mixer - Spirit - Mirror 100x70cm - Luna
Mueble 100cm - Blanc - Lavabo céramique 101cm - Modern - Mitigeur monocommande lavabo - Spirit - Miroir 100x70cm - Luna
Mueble 100cm - Blanco - Encimera de lavabo cerámico 101cm - Modern - Monomando lavabo - Spirit - Espejo 100x70cm - Luna

espaços públicos
coleções sanitárias
sistemas de instalação
bases e banheiras
divisórias
acessórios de banho
torneiras
espelhos
móveis

Lavatórios

Lavabos · Washbasins

Os lavatórios cerâmicos CTESI unem qualidade, estética e durabilidade. Resistentes e fáceis de limpar, mantêm o aspeto de novo por mais tempo. Disponíveis em várias formas, tamanhos e acabamentos — incluindo modelos de encastrar, de pousar e duplos — oferecem soluções práticas e versáteis para qualquer projeto.

Los lavabos cerámicos CTESI combinan calidad, estética y durabilidad. Resistentes y fáciles de limpiar, mantienen su aspecto como nuevo durante más tiempo. Disponibles en diversas formas, tamaños y acabados —incluyendo modelos empotrados, sobre encimera y dobles— ofrecen soluciones prácticas y versátiles para cualquier proyecto.

CTESI ceramic washbasins merge style, durability, and functionality. Designed to be durable and easy to clean, they stay looking like new for longer. Available in a range of shapes, sizes, and finishes — including built-in, countertop, and double models — they offer practical, versatile solutions for every bathroom project.

Les lavabos céramiques CTESI allient qualité, esthétique et durabilité. Résistants et faciles à nettoyer, ils conservent leur aspect neuf plus longtemps. Disponibles en plusieurs formes, tailles et finitions — y compris modèles encastrés, à poser et doubles — ils offrent des solutions pratiques et polyvalentes pour tous les projets.



**MODERN**

Lavatório cerâmico · Ceramic washbasin
Lavabo céramique · Lavabo cerâmico

REF.	mm	€
BL6002160	510 X 390	80,00
BL6002100	610 X 460	80,00
BL6002105	710 x 460	90,00
BL6002110	810 X 460	100,00
BL6002120	1010 X 460	130,00
BL6002130	1210 X 460	190,00

**MODERN DUO**

Lavatório cerâmico 2 pias · Ceramic washbasin 2 sinks
Lavabo céramique 2 vasques · Lavabo cerâmico 2 senos

REF.	mm	€
BL6002135	1210 X 465	210,00

**LEFT**

Lavatório cerâmico · Ceramic washbasin
Lavabo céramique · Lavabo cerâmico

REF.	mm	€
BL6001000	810 X 465	110,00
BL6001020	1010 X 465	180,00
BL6001030	1210 X 465	240,00

**RIGHT**

Lavatório cerâmico · Ceramic washbasin
Lavabo céramique · Lavabo cerâmico

REF.	mm	€
BL6001110	810 X 465	110,00
BL6001120	1010 X 465	180,00
BL6001130	1210 X 465	240,00

**SHORT**

Lavatório cerâmico · Ceramic washbasin
Lavabo céramique · Lavabo cerâmico

REF.	mm	€
BL6000410	610 X 395	100,00
BL6000420	810 X 395	140,00
BL6000430	1010 X 395	210,00

**FLAT**

Lavatório cerâmico · Ceramic washbasin
Lavabo céramique · Lavabo cerâmico

REF.	mm	€
BL6000590	420 X 360	60,00
BL6000500	510 X 360	80,00
BL6000510	610 X 360	90,00
BL6000520	810 X 360	110,00

espelhos

torneiras

acessórios
de banho

divisórias

bases e
banheirassistemas de
instalaçãocoleções
sanitáriasespaços
públicos

**NEVADA**

Lavatório cerâmico · Ceramic washbasin
Lavabo céramique · Lavabo cerâmico

REF.	mm	ⓘ	€
BL6006330	Ø 395	115 mm	90,00

**NEVADA**

Lavatório cerâmico - preto mate · Ceramic washbasin - matte black
Lavabo céramique - noir mat · Lavabo cerâmico - negro mate

REF.	mm	ⓘ	€
BL6006331	Ø 395	115 mm	170,00

**NEVADA**

Lavatório cerâmico - ouro brilho · Ceramic washbasin - glossy gold
Lavabo céramique - or brillant · Lavabo cerâmico - oro brillo

REF.	mm	ⓘ	€
BL6006332	Ø 395	115 mm	230,00

**NEVADA**

Lavatório cerâmico - bronze brilho · Ceramic washbasin - bronze gold
Lavabo céramique - bronze brillant · Lavabo cerâmico - bronze brillo

REF.	mm	ⓘ	€
BL6006333	Ø 395	115 mm	230,00

**TUNDRA**

Lavatório cerâmico · Ceramic washbasin
Lavabo céramique · Lavabo cerâmico

REF.	mm	€
BL6006355	505 x 375 x 110	110,00

**TUNDRA**

Lavatório cerâmico - preto mate · Ceramic washbasin - matte black
Lavabo céramique - noir mat · Lavabo cerâmico - negro mate

REF.	mm	€
BL6006356	505 x 375 x 110	200,00

**TUNDRA**

Lavatório cerâmico - ouro brilho · Ceramic washbasin - glossy gold
Lavabo céramique - or brillant · Lavabo cerâmico - oro brillo

REF.	mm	€
BL6006357	505 x 375 x 110	240,00

**TUNDRA**

Lavatório cerâmico - bronze brilho · Ceramic washbasin - bronze gold
Lavabo céramique - bronze brillant · Lavabo cerâmico - bronze brillo

REF.	mm	€
BL6006358	505 x 375 x 110	240,00

**COLD**Lavatório cerâmico · Ceramic washbasin
Lavabo céramique · Lavabo cerâmico

REF.	mm	ⓘ	€
BL6006310	Ø 415	135mm	90,00

**MELT**Lavatório cerâmico · Ceramic washbasin
Lavabo céramique · Lavabo cerâmico

REF.	mm	€
BL6006350	410 x 410 x 135	100,00

**NIVO**Lavatório cerâmico · Ceramic washbasin
Lavabo céramique · Lavabo cerâmico

REF.	mm	ⓘ	€
BL6006305	Ø 400	140mm	65,00

**FRESH**Lavatório cerâmico · Ceramic washbasin
Lavabo céramique · Lavabo cerâmico

REF.	mm	€
BL6006060	510 x 360 x 130	90,00

**SNAP**Lavatório cerâmico · Ceramic washbasin
Lavabo céramique · Lavabo cerâmico

REF.	mm	€
BL6006340	530 x 310 x 115	110,00

**FREEZE**Lavatório cerâmico · Ceramic washbasin
Lavabo céramique · Lavabo cerâmico

REF.	mm	€
BL6006050	380 x 350 x 150	80,00

**MISTIC**Lavatório cerâmico · Ceramic washbasin
Lavabo céramique · Lavabo cerâmico

REF.	mm	€
BL6006095	425 x 425 x 145	90,00

**FROST**Lavatório cerâmico · Ceramic washbasin
Lavabo céramique · Lavabo cerâmico

REF.	mm	€
BL6006090	500 x 400 x 145	100,00

Espelhos · Espejos · Mirrors · Miroirs

Os espelhos CTESI combinam sofisticação e personalização. Disponíveis em várias formas e tamanhos, alguns modelos incluem iluminação LED com película de segurança anti-quebra e regulação da cor da luz, unindo funcionalidade e elegância.

Les miroirs CTESI allient sophistication et personnalisation. Disponibles en plusieurs formes et tailles, certains modèles incluent un éclairage LED avec film de sécurité anti-casse et réglage de la couleur de la lumière, combinant fonctionnalité et élégance.

CTESI mirrors offer sophistication and customization. Available in various shapes and sizes, some models include LED lighting with shatterproof film and adjustable color temperature, combining elegance and functionality.

Los espejos CTESI combinan sofisticación y personalización. Disponibles en diversas formas y tamaños, algunos modelos incluyen iluminación LED con película de seguridad anti-rotura y regulación del color de la luz, uniendo funcionalidad y elegancia.

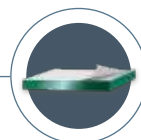
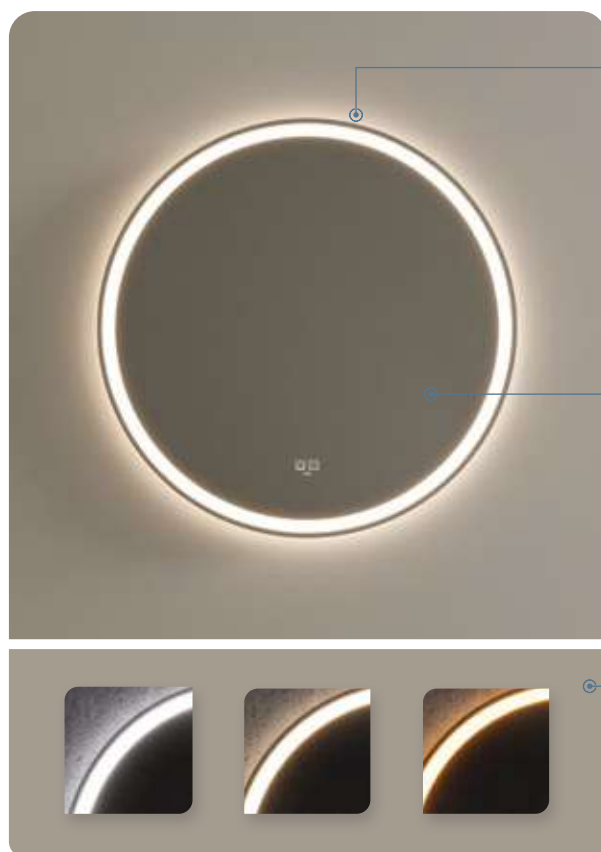

- Espelhos LED com película de segurança anti-quebra
- LED mirrors with anti-break safety film
- Miroirs LED avec film de sécurité anti-casse
- Espejos con luz LED con película de seguridad anti-rotura

- espelho copper-free
- grau de proteção IP44
- classe energética E
- Copper-free mirror
- Protection rating IP44
- Energy class E
- Miroir sans cuivre
- Degré de protection IP44
- Classe énergétique E
- espejo copper-free
- grado de protección IP44
- clase energética E

- regulador 3CCT que define a cor da luz (quente, fria ou neutra)*
- 3CCT dimmer that sets the light color (warm, cool, or neutral)*
- Régulateur 3CCT qui définit la couleur de la lumière (chaude, froide ou neutre)*
- regulador 3CCT que define el color de la luz (cálida, fría o neutra)



cor
color
couleur
color



intensidade da luz
light intensity
intensité de la lumière
intensidad de luz

Personalize

À sua medida e forma

Customize it to your specifications and shape.

Personnalisez-le selon vos spécifications et la forme souhaitée.

Personalízalo según tus especificaciones y forma.

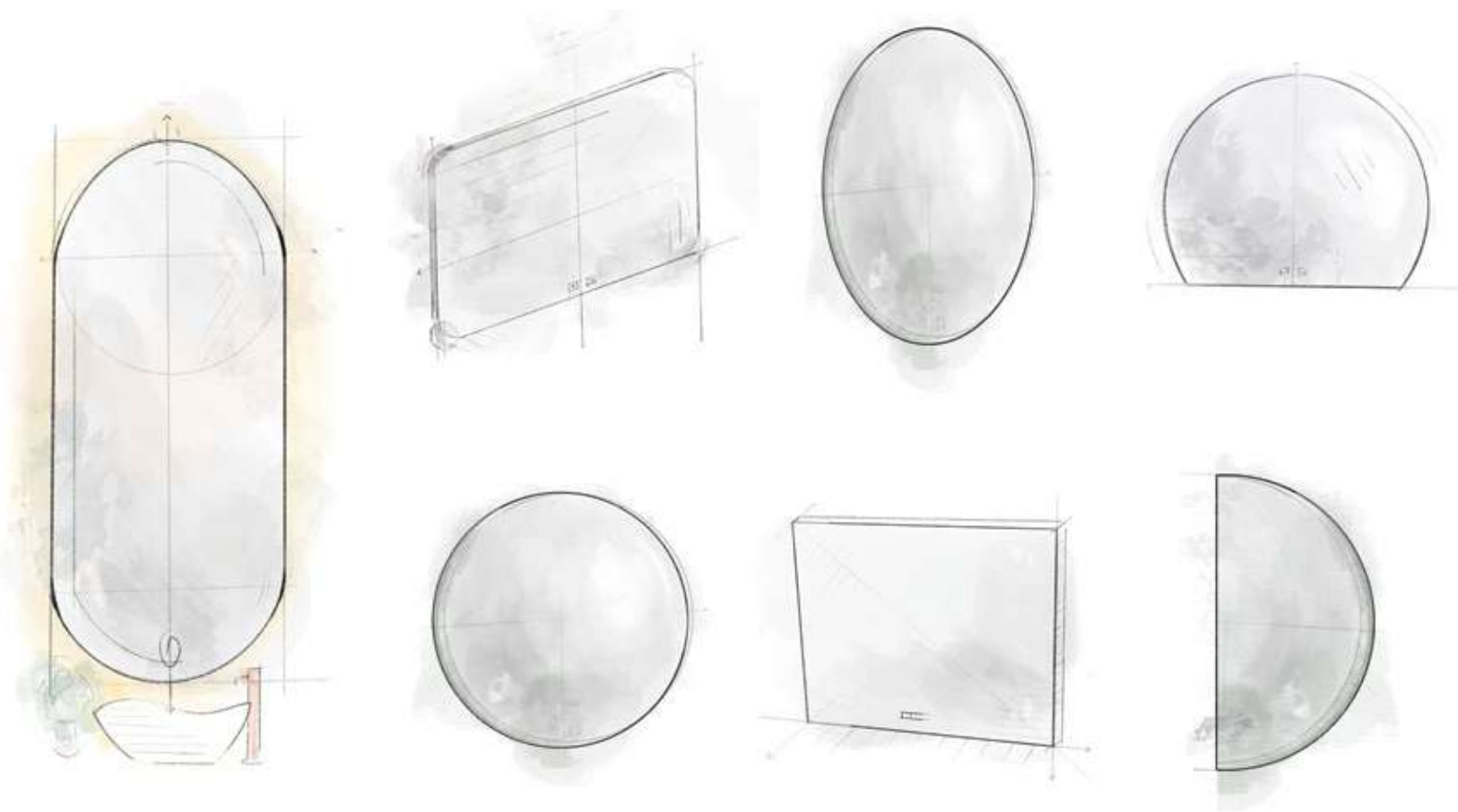



Illusion

ref.	cm	€
BL5003100	60 X 80	210,00

STOCK



Moon

ref.	cm	€
BL5003000	Ø 60	190,00
BL5003010	Ø 80	250,00

STOCK



Tag

ref.	cm	€
BL5003200	80 X 60	260,00
BL5003210	100 x 60	310,00
BL5003220	120 x 60	340,00

STOCK



Aura

ref.	cm	€
BL5003300	50 X 100	270,00

STOCK



ref.	cm	€
BL5003800	60 X 70	240,00
BL5003810	80 X 70	270,00
BL5003820	100 X 70	310,00
BL5003830	120 X 70	340,00

STOCK



ref.	cm	€
BL5003600	60 X 70	200,00
BL5003610	80 x 70	220,00
BL5003620	100 x 70	260,00
BL5003630	120 x 70	290,00

STOCK



ref.	cm	€
BL5003900	60 X 70	220,00
BL5003910	80 X 70	260,00
BL5003920	100 X 70	300,00
BL5003930	120 X 70	330,00

STOCK



ref.	cm	€
BL5003400	Ø 60	180,00
BL5003410	Ø 80	220,00
BL5003420	Ø 90	295,00
BL5003430	Ø 100	340,00

STOCK

móveis

espelhos

torneiras

acessórios
de banho

divisórias

bases e
banheiras

sistemas de
instalação

coleções
sanitárias

espaços
públicos



Sunset

ref.	cm	€
BL5003500	Ø 60	160,00
BL5003510	Ø 80	200,00
BL5003520	Ø 90	285,00
BL5003530	Ø 100	320,00

STOCK

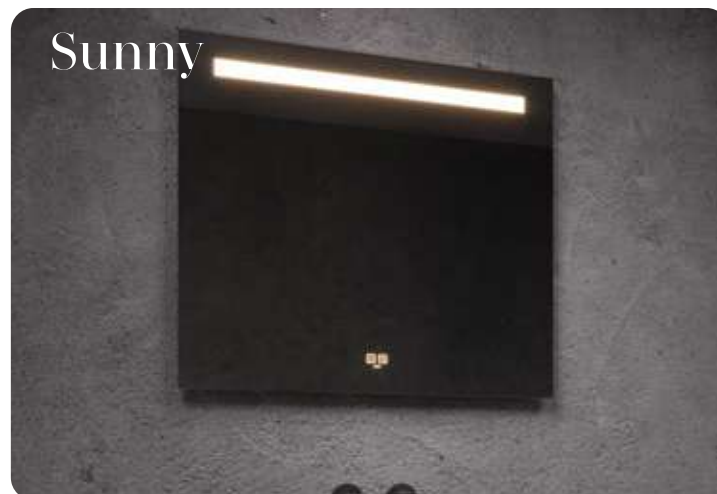

Sunny

ref.	cm	€
BL5003700	60 X 70	160,00
BL5003710	80 x 70	190,00
BL5003720	100 x 70	220,00
BL5003730	120 x 70	260,00

STOCK



Alva

ref.	cm	€
BL8901010	60 X 100	79,00
BL8901015	70 x 100	107,00
BL8901030	80 x 100	135,00
BL8901040	100 x 100	174,00
BL8901050	120 x 100	212,00

STOCK



Luna

ref.	cm	€
BL8900320	60 X 70	62,00
BL8900325	70 x 70	68,00
BL8900330	80 x 70	73,00
BL8900340	100 x 70	90,00
BL8900350	120 x 70	114,00

STOCK



ref.	cm	€
BL8900160	Ø 60	47,50
BL8900162	Ø 80	70,00

STOCK

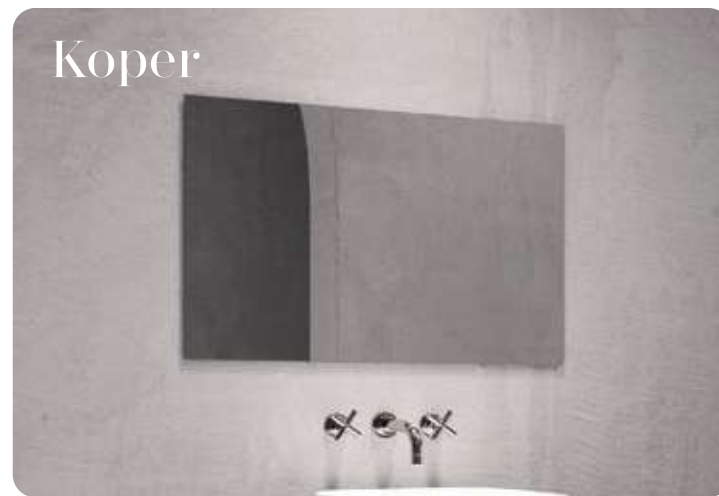

ref.	cm	€
BL8900130	80 X 60	45,00

STOCK



ref.	cm	€
BL50014 __	60 X 75	60,00
BL50015 __	80 X 75	70,00
BL50016 __	100 X 75	80,00
BL50017 __	120 X 75	115,00

STOCK

00		BRANCO BLANCO
86		HERA
84		NOGAL

10

88		RIGA	83		TABACO
92		OAK	82		CEREJO
93		NUT	89		MOCCA

ctesi

ffppj
Colors





espaços
públicos

coleções
sanitárias

sistemas de
instalação

bases e
banheiras

divisórias

acessórios
de banho

torneiras

espelhos

móveis

Torneiras

Faucets • Robinetterie • Grifos



As torneiras CTESI unem design, funcionalidade e fiabilidade. Desenvolvidas com rigoroso controlo de qualidade, garantem desempenho seguro no dia a dia. Com materiais resistentes à corrosão e linhas modernas, valorizam qualquer espaço, oferecendo qualidade e estilo que perduram.

Les robinetteries CTESI allient design, fonctionnalité et fiabilité. Développées avec un contrôle qualité rigoureux, elles garantissent des performances sûres au quotidien. Avec des matériaux résistants à la corrosion et des lignes modernes, elles valorisent tous les espaces, offrant qualité et style durables.

CTESI faucets blend design, functionality, and reliability. Built with rigorous quality standards, they deliver safe everyday performance. Featuring corrosion-resistant materials and contemporary lines, they enhance any space with lasting style and quality.

Los grifos CTESI combinan diseño, funcionalidad y fiabilidad. Desarrollados con un riguroso control de calidad, garantizan un rendimiento seguro en el día a día. Con materiales resistentes a la corrosión y líneas modernas, realzan cualquier espacio, ofreciendo calidad y estilo que perduran.

-
- 136. PLANE
 - 140. TYPE
 - 144. KNOBE
 - 148. KEEN
 - 152. SPIRIT
 - 156. FOCUS
 - 158. JAZZY
 - 161. DUCHETAS
 - 162. COLUNAS DE DUCHE
 - 164. TORNEIRAS COZINHA
 - 168. SISTEMAS DE DUCHE

Sustentabilidade

Sostenibilidad | Sustainability | Durabilité

Qualidade superior

Calidad superior | Superior quality | Qualité supérieure

As torneiras CTESI combinam sustentabilidade e qualidade. Desenvolvidas com responsabilidade ambiental, garantem maior durabilidade e menor impacto ecológico.

Com resistência excepcional à corrosão e produzidas sem chumbo, são uma escolha segura, fiável e comprometida com a preservação da água potável e um futuro mais sustentável.

CTESI faucets combine sustainability and quality. Developed with environmental responsibility, they ensure greater durability and a reduced ecological impact.

With exceptional corrosion resistance and manufactured lead-free, they are a safe and reliable choice, committed to preserving drinking water and supporting a more sustainable future.

Les robinetteries CTESI allient durabilité et qualité. Développées dans le respect de l'environnement, elles garantissent une plus grande longévité et un impact écologique réduit.

Avec une résistance exceptionnelle à la corrosion et fabriquées sans plomb, elles représentent un choix sûr, fiable et engagé pour la préservation de l'eau potable et un avenir plus durable.

Los grifos CTESI combinan sostenibilidad y calidad. Desarrollados con responsabilidad ambiental, garantizan mayor durabilidad y un menor impacto ecológico.

Con una resistencia excepcional a la corrosión y fabricados sin plomo, son una opción segura, fiable y comprometida con la preservación del agua potable y un futuro más sostenible.



ABERTURA SUAVE

Movimentos mais graciosos na operação do manípulo da torneira, dando maior controlo do caudal de água.

APERTURA SUAVE

Movimientos más elegantes al accionar la maneta del grifo, lo que proporciona un mayor control del caudal de agua.

SOFT OPENING

Smoother movements when operating the faucet handle, providing greater control of the water flow.

OUVERTURE DOUCE

Mouvements plus fluides lors de la manipulation du levier du robinet, offrant un meilleur contrôle du débit d'eau.



LIMITADOR DE CAUDAL

Permite ajustar o fluxo máximo do caudal evitando gastar mais água do que o necessário.

LIMITADOR DE CAUDAL

Permite ajustar el caudal máximo para evitar desperdiciar más agua de la necesaria.

FLOW RESTRICTOR

Allows adjusting the maximum water flow, preventing the use of more water than necessary.

LIMITEUR DE DÉBIT

Permet de régler le débit maximal, évitant de consommer plus d'eau que nécessaire.



ABERTURA A FRIO

A abertura da torneira na posição inicial inicia sempre com água fria poupando no consumo energético.

ARRANQUE EN FRÍO

Al abrir el grifo en la posición inicial, siempre sale agua fría, lo que ahorra consumo de energía.

COLD START

The faucet opens in the initial position always with cold water, saving energy consumption.

OUVERTURE À FROID

L'ouverture du robinet en position initiale commence toujours avec de l'eau froide, économisant ainsi la consommation d'énergie.



LIMITADOR DE TEMPERATURA

Permite ajustar a temperatura da água em diferentes níveis evitando consumos de energia indevidos.

LIMITADOR DE TEMPERATURA

Permite ajustar la temperatura del agua a diferentes niveles, evitando un consumo excesivo de energía.

TEMPERATURE LIMITER

Allows adjusting the water temperature at different levels, preventing unnecessary energy consumption.

LIMITEUR DE TEMPÉRATURE

Permet de régler la température de l'eau à différents niveaux, évitant ainsi des consommations d'énergie inutiles.



ECO-ENERGY

Poupança de até 10% de energia e 22% de água

Sistema de abertura sempre com água fria, evitando o acionamento desnecessário do sistema de aquecimento. Controlo de temperatura ao rodar gradualmente o manípulo para a esquerda, ativa o fluxo de água quente de modo controlado.

A função SUAVE torna o manuseamento 40% mais eficiente e preciso da temperatura e fluxo de água.

Saves up to 10% energy and 22% water

Cold-start system, avoiding unnecessary activation of the heating system.

Temperature control by gradually turning the handle.

Turning counterclockwise activates the hot water flow in a controlled way.

The SMOOTH function makes temperature and water flow control 40% more efficient and precise.

Économie jusqu'à 10 % d'énergie et 22 % d'eau

Sistema de abertura siempre con agua fría, evitando activaciones innecesarias del sistema de calefacción. Control de temperatura girando gradualmente la perilla.

En sentido contrario a las agujas del reloj se activa el flujo de agua caliente de forma controlada.

La función SMOOTH hace que el manejo de la temperatura y la temperatura sean un 40% más eficientes y precisos flujo de agua.

Ecoenergía: Ahorro de hasta un 10% en Energía y un 22% en agua

Sistema de abertura siempre con agua fría, evitando activaciones innecesarias del sistema de calefacción. Control de temperatura girando gradualmente la perilla.

En sentido contrario a las agujas del reloj se activa el flujo de agua caliente de forma controlada.

La función SMOOTH hace que el manejo de la temperatura y la temperatura sean un 40% más eficientes y precisos flujo de agua.



ECO-SAFE

Economizar água de um modo inteligente

A regulação do fluxo de água ocorre em dois níveis: abertura total e meia abertura.

Na posição de meia abertura, o caudal é de 50%, adequado para a maioria das utilizações.

Isto resulta numa redução da pegada hídrica e em poupanças financeiras substanciais.

Eco-Safe permite uma economia significativa sem comprometer o conforto ou a funcionalidade.

Save water in a smart way

The water flow regulation works on two levels: full opening and half opening.

At the half-opening position, the flow rate is reduced to 50%, suitable for most uses.

This leads to a reduced water footprint and substantial financial savings.

Eco-Safe enables significant savings without compromising comfort or functionality.

Eco-Safe: Ahorrar agua de forma inteligente

La regulación del caudal de agua se produce en dos niveles: apertura total y media apertura.

En posición semiabierta, el caudal es del 50%, apto para la mayoría de usos.

Esto da como resultado una huella hídrica reducida y ahorros financieros sustanciales.

Eco-Safe permite ahorros importantes sin comprometer la comodidad ni la funcionalidad.

Économiser l'eau de manière intelligente

La régulation du débit d'eau s'effectue à deux niveaux : ouverture totale et demi-ouverture.

En position de demi-ouverture, le débit est de 50 %, ce qui convient à la majorité des usages.

Cela permet de réduire l'empreinte hydrique et de réaliser des économies substantielles.

Eco-Safe permet une économie significative sans compromettre le confort ni la fonctionnalité.

Acabamentos

Finishes · Finitions · Acabados

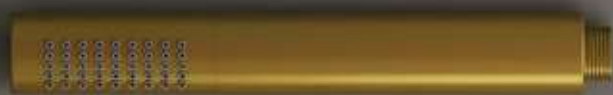

04
ouro mate
matte gold
or mat
oro mate



03
ouro escovado
brushed gold
or brossé
oro cepillado



02
ouro
gold
or
oro



00
cromado
chrome
chromé
cromo



05
preto mate
matte black
noir mat
negro mate



09
bronze escovado
brushed bronze
bronze brossé
bronce cepillado



01
satinox

Cores · colors
couleurs · colores

06 · 07 · 25 · 40 · 42 · 44

Metals · metals
métaux · metales

01 · 02 · 03 · 04 · 08 · 09



08
bronze
bronze
bronze
bronze



42
azul brilho
bright blue
bleu briller
azul brillo



40
vermelho brilho
bright red
rouge briller
rojo brillo



44
amarelo brilho
bright yellow
jaune briller
amarillo brillo



25
cashmere mate
matte cashmere
cashmere mat
cashmere mate



06
branco mate
matte white
blanc mat
blanco mate



07
grafite mate
graphite matte
graphite mat
grafito mate

móveis

espelhos

torneiras

acessórios
de banho

divisórias

bases e
banheiras

sistemas de
instalação

coleções
sanitárias

espaços
públicos

Plane

As linhas planas e acentuadamente retilíneas vinculam a personalidade deste modelo. Tudo nesta torneira emana contemporaneidade.

The flat, distinctly straight lines highlight this model's character. Everything about this tap exudes contemporaneity.

Les lignes plates et résolument rectilignes soulignent la personnalité de ce modèle. Tout dans ce mitigeur évoque la contemporanéité.

Con sus líneas puras y claras, el grifo Font se destaca por la forma como sobresale en tu baño. Todo en este grifo desprende un estilo contemporáneo.

Acabamentos • finishes • finitions • acabados



00
cromado
chrome
chromé
cromo



01
satinox



02
ouro
gold
or
oro



03
ouro escovado
brushed gold
or brossé
oro cepillado



04
ouro mate
matte gold
or mat
oro mate



05
preto mate
matte black
noir mat
negro mate



06
branco mate
matte white
blanc mat
blanco mate



07
grafite mate
graphite matte
graphite mat
grafito mate



08
bronze escovado
brushed bronze
bronze brossé
bronze cepillado



09
bronze
bronze
bronze
bronce



25
cashmere mate
matte cashmere
cashmere mat
cashmere mate



40
vermelho brilho
bright red
rouge briller
rojo brillo



42
azul brilho
bright blue
bleu briller
azul brillo



44
amarelo brilho
bright yellow
jaune briller
amarillo brillo

Cores • colors • couleurs • colores
06 • 07 • 25 • 40 • 42 • 44

Metals • metals • métaux • metales
01 • 02 • 03 • 04 • 08 • 09

Monocomando lavatório alto
High basin mixer tap
Mitigeur lavabo haut
Monomando lavabo alto

142,40€

Cromado • chrome chrome • cromo	CT2519200	142,40 €
Preto • black noir • negro	CT2519205	170,90 €
Cores • colors couleurs • colores	CT25192 __	185,10 €
Metals • metals métaux • metales	CT25192 __	199,40 €

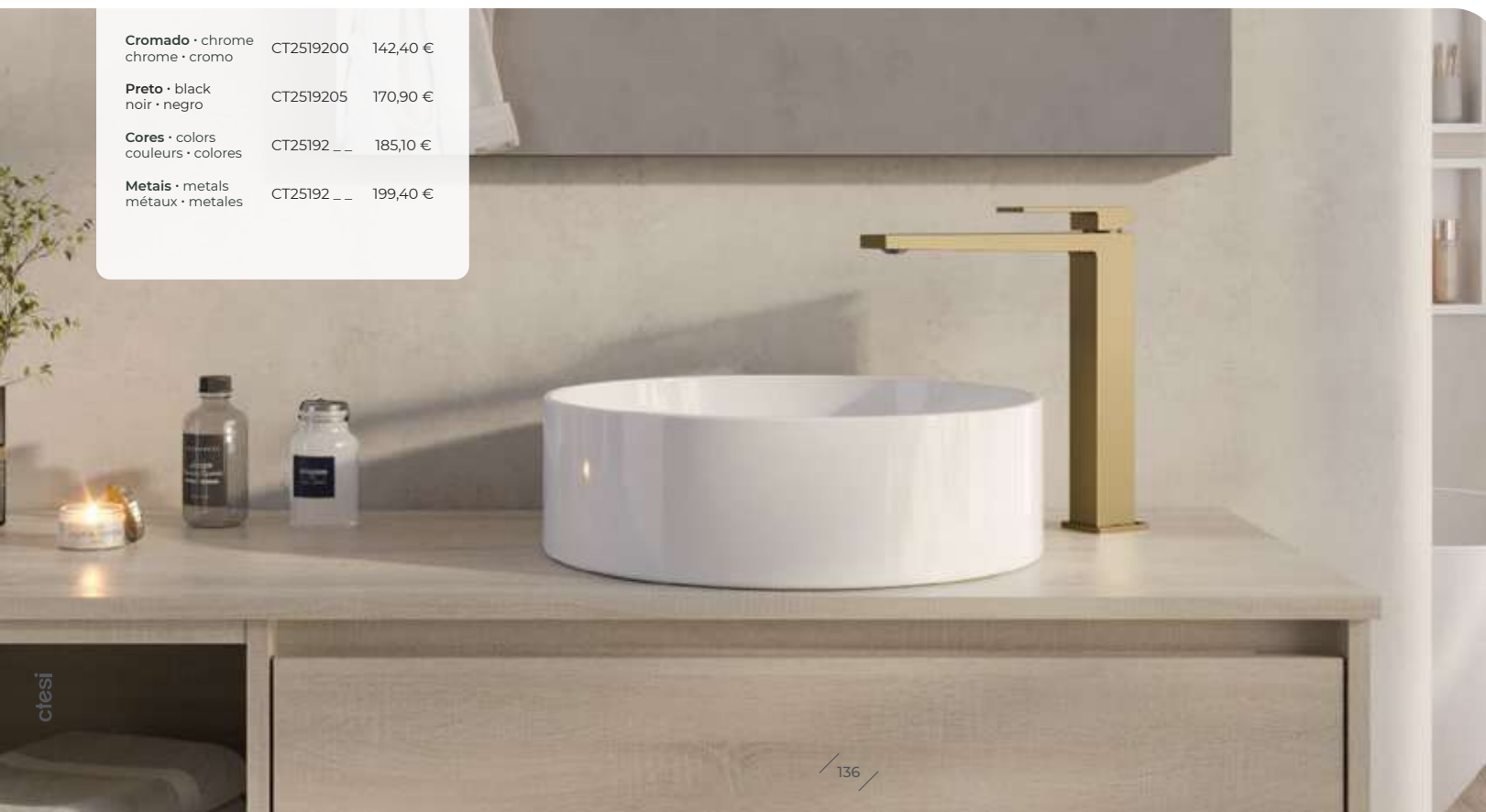



Monocomando lavatório
Basin mixer tap
Mitigeur lavabo
Monomando lavabo

93,10€

Cromado · chrome chrome · cromo	CT2519000	93,10 €
Preto · black noir · negro	CT2519005	111,70 €
Cores · colors couleurs · colores	CT25190 __	121,00 €
Metais · metals métaux · metales	CT25190 __	130,30 €



Monocomando bidé
Bidet mixer tap
Mitigeur bidet
Monomando bidé

93,10€

Cromado · chrome chrome · cromo	CT2519400	93,10 €
Preto · black noir · negro	CT2519405	111,70 €
Cores · colors couleurs · colores	CT25194 __	121,00 €
Metais · metals métaux · metales	CT25194 __	130,0 €



Monocomando lavatório de encastrar
Built-in basin mixer tap
Mitigeur lavabo encastré
Monomando lavabo empotrable

234,30€

Cromado · chrome chrome · cromo	CT2710000	234,30 €
Preto · black noir · negro	CT2710005	282,40 €
Cores · colors couleurs · colores	CT27100 __	302,50 €
Metais · metals métaux · metales	CT27100 __	327,20 €

Inclui box de encastrar
Includes built-in box
Comprend un boîtier encastré
Incluye box para empotrar



Monocomando lavatório de encastrar duo
Built-in basin mixer tap duo
Mitigeur lavabo encastré duo
Monomando lavabo empotrable duo

223,70€

Cromado · chrome chrome · cromo	CT2710200	223,70 €
Preto · black noir · negro	CT2710205	269,70 €
Cores · colors couleurs · colores	CT27102 __	288,70 €
Metais · metals métaux · metales	CT27102 __	312,40 €

Inclui box de encastrar
Includes built-in box
Comprend un boîtier encastré
Incluye box para empotrar

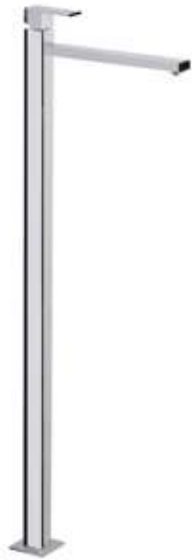

Monocomando lavatório de chão
single lever basin floor mounting mixer
mitigeur monocommande lavabo montage au sol
monomando lavabo de solo

890,00€

Cromado · chrome
chrome · cromo CT2519800 890,00 €

Preto · black
noir · negro CT2519805 1068,00 €

Cores · colors
couleurs · colores CT25198 __ 1157,00 €

Metals · metals
métaux · metales CT25198 __ 1246,00 €



Monocomando banheira
single lever bath mixer
mitigeur monocommande baignoire
monomando mural bañera

163,20€

Cromado · chrome
chrome · cromo CT2519600 163,20 €

Preto · black
noir · negro CT2519605 195,80 €

Cores · colors
couleurs · colores CT25196 __ 212,20 €

Metals · metals
métaux · metales CT25196 __ 228,50 €



Monocomando duche
single lever shower mixer
mitigeur monocommande douche
monomando mural ducha

127,10€

Cromado · chrome
chrome · cromo CT2519700 127,10 €

Preto · black
noir · negro CT2519705 152,50 €

Cores · colors
couleurs · colores CT25197 __ 165,20 €

Metals · metals
métaux · metales CT25197 __ 177,90 €



Monocomando banheira de chão
single lever bath floor mounting mixer
mitigeur monocommande baignoire montage au sol
monomando bañera de solo

990,00€

Cromado · chrome
chrome · cromo CT2519900 990,00 €

Preto · black
noir · negro CT2519905 1188,00 €

Cores · colors
couleurs · colores CT25199 __ 1287,00 €

Metals · metals
métaux · metales CT25199 __ 1386,00 €



Square
Kit ducheta higiénica
hygienic shower kit
kit douchete hugiénique
kit ducheta higienica

158,50€

Cromado · chrome
chrome · cromo CT2222400 158,50 €

Preto · black
noir · negro CT2222405 190,20 €

Cores · colors
couleurs · colores CT22224 __ 206,10 €

Metals · metals
métaux · metales CT22224 __ 221,90 €



Coluna de duche
shower column
colonne de douche
columna de ducha

440,00€

Cromado · chrome
chrome · cromo CT2520100 440,00 €

Preto · black
noir · negro CT2520105 528,00 €

Cores · colors
couleurs · colores CT25201 __ 572,00 €

Metais · metals
métaux · metales CT25201 __ 616,00 €



Coluna de duche termostática
thermostatic shower column
colonne thermostatique de douche
columna termostática de ducha

460,00€

Cromado · chrome
chrome · cromo CT2520800 460,00 €

Preto · black
noir · negro CT2520805 552,00 €

Cores · colors
couleurs · colores CT25208 __ 598,00 €

Metais · metals
métaux · metales CT25208 __ 644,00 €



SISTEMA DE DUCHE - 2 VIAS
SISTEMA DE DUCHA - 2 SALIDAS

C/ DESVIADOR

352,10€

Cromado · chrome
chrome · cromo CT2255700 352,10 €

Preto · black
noir · negro CT2255705 422,50 €

Cores · colors
couleurs · colores CT22557 __ 457,70 €

Metais · metals
métaux · metales CT22557 __ 492,90 €



Sistema de duche 1 via
shower system 1 way
système de douche 1 sortie
sistema de ducha 1 salida

206,80€

Cromado · chrome
chrome · cromo CT2255600 206,80 €

Preto · black
noir · negro CT2255605 248,20 €

Cores · colors
couleurs · colores CT22556 __ 268,80 €

Metais · metals
métaux · metales CT22556 __ 289,50 €

móveis

espelhos

torneiras

acessórios
de banho

divisórias

bases e
banheiras

sistemas de
instalação

coleções
sanitárias

espaços
públicos

Type

A torneira Type é uma escolha que representa o ajuste perfeito entre a fluidez das linhas e a funcionalidade. Assente numa base cilíndrica como uma forma basilar para o equilíbrio do seu espaço de banho esta torneira assume-se como uma peça adaptável a diferentes estilos.

A torneira Type valoriza-se pelo seu fácil manuseamento, para que viva o seu dia-a-dia de forma prática e confortável.

The Type faucet is a choice that represents the perfect balance between fluid lines and functionality. Built upon a cylindrical base as a fundamental shape for the harmony of your bathroom, this faucet stands out as an adaptable piece for different styles.

The Type faucet is enhanced by its ease of use, ensuring your daily routine is both practical and comfortable.

Le robinet Type est un choix qui représente l'accord parfait entre la fluidité des lignes et la fonctionnalité. Reposant sur une base cylindrique comme forme fondamentale pour l'équilibre de votre salle de bain, ce robinet s'impose comme une pièce adaptable à différents styles.

Le robinet Type se distingue par sa facilité d'utilisation, pour que vous profitiez de votre quotidien de manière pratique et confortable.

El grifo Type es una opción que representa el ajuste perfecto entre la fluidez de sus líneas y la funcionalidad. Este grifo se apoya en un cilindro como forma básica de equilibrar tu baño y se asume como una pieza adaptable a diferentes estilos.

El modelo Type se destaca por su fácil manejo, para que puedas vivir tu día a día de forma práctica y cómoda.

Acabamentos · finishes · finitions · acabados



00
cromado
chrome
chromé
cromo



01
satinox



02
ouro
gold
or
oro



03
ouro escovado
brushed gold
or brossé
oro cepillado



04
ouro mate
matte gold
or mat
oro mate



05
preto mate
matte black
noir mat
negro mate



06
branco mate
matte white
blanc mat
blanco mate



07
grafite mate
graphite matte
graphite mat
grafito mate



08
bronze escovado
brushed bronze
bronze brossé
bronze cepillado



09
bronze
bronze
bronze
bronce



25
cashmere mate
matte cashmere
cashmere mat
cashmere mate



40
vermelho brilho
bright red
rouge briller
rojo brillo



42
azul brilho
bright blue
bleu briller
azul brillo



44
amarelo brilho
bright yellow
jaune briller
amarillo brillo

Cores · colors · couleurs · colores
06 · 07 · 25 · 40 · 42 · 44

Metals · metals · métaux · metales
01 · 02 · 03 · 04 · 08 · 09 · 10

Monocomando lavatório alto
single lever tall basin mixer
mitigeur lavabo haut monocommande
monomando lavabo alto

116,50€

bica · spout · bec · caño
200 mm

Cromado · chrome CT2512400 116,50 €
chrome · cromo

Preto · black CT2512405 139,80 €
noir · negro

Cores · colors CT25124__ 151,50 €
couleurs · colores

Metals · metals CT25124__ 163,10 €
métaux · metales



eco ENERGY

eco ENERGY



Monocomando lavatório
single lever basin mixer
mitigeur monocommande lavabo
monomando lavabo

78,60€

Cromado · chrome chrome · cromo	CT2512000	78,60 €
Preto · black noir · negro	CT2512005	94,40 €
Cores · colors couleurs · colores	CT25120__	102,20 €
Metais · metals métaux · metales	CT25120 __	110,10 €

Monocomando bidé
single lever bidet basin mixer
mitigeur monocommande bidet
monomando bidé

78,60€

Cromado · chrome chrome · cromo	CT2512600	78,60 €
Preto · black noir · negro	CT2512605	94,40 €
Cores · colors couleurs · colores	CT25126 __	102,20 €
Metais · metals métaux · metales	CT25126 __	110,10 €



Monocomando lavatório de encastrar
single lever built-in basin mixer
mitigeur monocommande encastrable
monomando mural empotrado

197,30€

Cromado · chrome chrome · cromo	CT2711000	197,30 €
Preto · black noir · negro	CT2711005	237,70 €
Cores · colors couleurs · colores	CT27110 __	253,20 €
Metais · metals métaux · metales	CT27110 __	274,00 €

Inclui box de encastrar
Includes built-in box
Comprend un boîtier encastré
Incluye box para empotrar



Monocomando lavatório encastrar duo
single lever built-in basin mixer duo
mitigeur monocommande encastrable duo
monomando mural empotrado duo

186,70€

Cromado · chrome chrome · cromo	CT2711200	186,70 €
Preto · black noir · negro	CT2711205	225,00 €
Cores · colors couleurs · colores	CT27112 __	239,40 €
Metais · metals métaux · metales	CT27112 __	259,10 €

Inclui box de encastrar
Includes built-in box
Comprend un boîtier encastré
Incluye box para empotrar



móveis

espelhos

torneiras

acessórios
de banho

divisórias

bases e
banheiras

sistemas de
instalação

coleções
sanitárias

espaços
públicos



Monocomando lavatório de chão
 floor-mounted basin mixer
 mitigeur sur pied pour lavabo
 monomando lavabo con toma a suelo

690,00€

Cromado · chrome chrome · cromo	CT2514800	690,00 €
Preto · black noir · negro	CT2514805	828,00 €
Cores · colors couleurs · colores	CT25148 __	897,00 €
Metals · metals métaux · metales	CT25148 __	966,00 €



Monocomando banheira de chão
 floor-mounted bath mixer
 mitigeur sur pied pour baignoire
 monomando bañera con toma a suelo

820,00€

Cromado · chrome chrome · cromo	CT2514900	820,00 €
Preto · black noir · negro	CT2514905	984,00 €
Cores · colors couleurs · colores	CT25149 __	1066,00 €
Metals · metals métaux · metales	CT25149 __	1148,00 €

Monocomando banheira
 single lever bath mixer
 mitigeur monocommande baignoire
 monomando mural bañera

186,80€



Cromado · chrome chrome · cromo	CT2512800	186,80 €
Preto · black noir · negro	CT2512805	224,20 €
Cores · colors couleurs · colores	CT25128 __	242,90 €
Metals · metals métaux · metales	CT25128 __	261,60 €



Trevi
 Kit ducheta higiénica
 Hygienic spray kit
 Kit hygiénique
 Kit ducheta higiénica

117,50€

Cromado · chrome chrome · cromo	CT2222300	117,50 €
Preto · black noir · negro	CT2222305	141,00 €
Cores · colors couleurs · colores	CT22223 __	152,80 €
Metals · metals métaux · metales	CT22223 __	164,50 €



Monocomando duche
 single lever shower mixer
 mitigeur monocommande douche
 monomando mural ducha

157,70€

Cromado · chrome chrome · cromo	CT2512900	157,70 €
Preto · black noir · negro	CT2512905	189,30 €
Cores · colors couleurs · colores	CT25129 __	205,10 €
Metals · metals métaux · metales	CT25129 __	220,80 €



Coluna de duche termostática
thermostatic shower column
colonne thermostatique de douche
columna termostática de ducha

390,00€

Cromado · chrome chrome · cromo	CT2521200	390,00 €
Preto · black noir · negro	CT2521205	468,00 €
Cores · colors couleurs · colores	CT25212 __	507,00 €
Metais · metals métaux · metales	CT25212 __	546,00 €



Sistema de duche 1 via
shower system 1 way
système de douche 1 sortie
sistema de ducha 1 salida

187,60€

Cromado · chrome chrome · cromo	CT2255300	187,60 €
Preto · black noir · negro	CT2255305	225,10 €
Cores · colors couleurs · colores	CT22553 __	243,90 €
Metais · metals métaux · metales	CT22553 __	262,60 €



Sistema de duche 2 vias
shower system 2 ways
système de douche 2 sorties
sistema de ducha 2 salidas

338,70€

Cromado · chrome chrome · cromo	CT2255400	338,70 €
Preto · black noir · negro	CT2255405	406,40 €
Cores · colors couleurs · colores	CT22554 __	440,30 €
Metais · metals métaux · metales	CT22554 __	474,20 €



Coluna de duche
shower column
colonne de douche
columna de ducha

370,00€

Cromado · chrome chrome · cromo	CT2521000	370,00 €
Preto · black noir · negro	CT2521005	444,00 €
Cores · colors couleurs · colores	CT25210 __	481,00 €
Metais · metals métaux · metales	CT25210 __	518,00 €



móveis

espelhos

torneiras

acessórios
de banho

divisórias

bases e
banheiras

sistemas de
instalação

coleções
sanitárias

espaços
públicos

Knobe

Knobe é a torneira que representa o elegante equilíbrio entre um desenho que se assume minimalista e a funcionalidade exigida aos espaços de duche contemporâneos.

Knobe is the faucet that represents the elegant balance between a design that embraces minimalism and the functionality required for contemporary shower spaces.

Knobe est le robinet qui représente l'équilibre élégant entre un design qui se veut minimaliste et la fonctionnalité exigée pour les espaces de douche contemporains.

El grifo Knobe representa el equilibrio perfecto entre un diseño minimalista y la funcionalidad requerida en los espacios de ducha contemporáneos.

Acabamentos · finishes · finitions · acabados



00
cromado
chrome
chromé
cromo



01
satinox



02
ouro
gold
or
oro



03
ouro escovado
brushed gold
or brossé
oro cepillado



04
ouro mate
matte gold
or mat
oro mate



05
preto mate
matte black
noir mat
negro mate



06
branco mate
matte white
blanc mat
blanco mate



07
grafite mate
graphite matte
graphite mat
grafito mate



08
bronze escovado
brushed bronze
bronze brossé
bronze cepillado



09
bronze
bronze
bronze



25
cashmere mate
matte cashmere
cashmere mat
cashmere mate



40
vermelho brilho
bright red
rouge briller
rojo brillo



42
azul brilho
bright blue
bleu briller
azul brillo



44
amarelo brilho
bright yellow
jaune briller
amarillo brillo

Cores · colors · couleurs · colores
06 · 07 · 25 · 40 · 42 · 44

Metals · metals · métaux · metales
01 · 02 · 03 · 04 · 08 · 09



Monocomando lavatório
single lever basin mixer
mitigeur monocommande lavabo
monomando lavabo

78,60€

Cromado · chrome
chrome · cromo CT2514000 78,60 €

Preto · black
noir · negro CT2514005 94,40 €

Cores · colors
couleurs · colores CT25140_ _ 102,20 €

Metals · metals
métaux · metales CT25140_ _ 110,10 €

Monocomando bidé
single lever bidet basin mixer
mitigeur monocommande bidet
monomando bidé

78,60€

Cromado · chrome
chrome · cromo CT2512600 78,60 €

Preto · black
noir · negro CT2512605 94,40 €

Cores · colors
couleurs · colores CT25126_ _ 102,20 €

Metals · metals
métaux · metales CT25126_ _ 110,10 €



Monocomando lavatório alto
single lever tall basin mixer
mitigeur lavabo haut monocommande
monomando lavabo alto

116,50€

bica · spout · bec · caño
200 mm

Cromado · chrome
chrome · cromo CT2514400 116,50 €

Preto · black
noir · negro CT2514405 139,80 €

Cores · colors
couleurs · colores CT25144__ 151,50 €

Metais · metals
métaux · metales CT25144__ 163,10 €

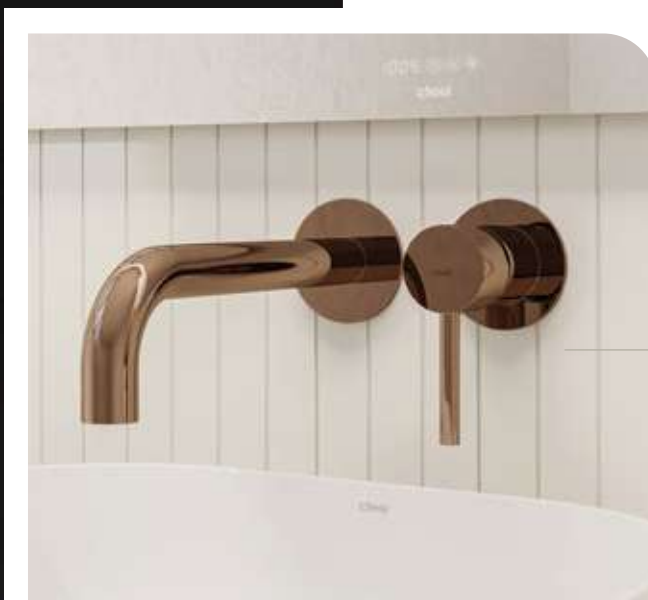

Monocomando lavatório de encastrar
single lever built-in basin mixer
mitigeur monocommande encastrable
monomando mural empotrado

197,30€

Cromado · chrome
chrome · cromo CT2714000 197,30 €

Preto · black
noir · negro CT2714005 237,70 €

Cores · colors
couleurs · colores CT27140__ 253,20 €

Metais · metals
métaux · metales CT27140__ 274,00 €

Inclui box de encastrar
Includes built-in box
Comprend un boîtier encastré
Incluye box para empotrar

Monocomando lavatório encastrar duo
single lever built-in basin mixer duo
mitigeur monocommande encastrable duo
monomando mural empotrado duo

186,70€

Cromado · chrome
chrome · cromo CT2714200 186,70 €

Preto · black
noir · negro CT2714205 225,00 €

Cores · colors
couleurs · colores CT27142__ 239,40 €

Metais · metals
métaux · metales CT27142__ 259,10 €

Inclui box de encastrar
Includes built-in box
Comprend un boîtier encastré
Incluye box para empotrar

Coluna de duche
shower column
colonne de douche
columna de ducha

370,00€

Cromado · chrome chrome · cromo	CT2521000	370,00 €
Preto · black noir · negro	CT2521005	444,00 €
Cores · colors couleurs · colores	CT25210 __	481,00 €
Metals · metals métaux · metales	CT25210 __	518,00 €



Monocomando banheira
single lever bath mixer
mitigeur monocommande baignoire
monomando mural bañera

186,80€

Cromado · chrome chrome · cromo	CT2512800	186,80 €
Preto · black noir · negro	CT2512805	224,20 €
Cores · colors couleurs · colores	CT25128 __	242,90 €
Metals · metals métaux · metales	CT25128 __	261,60 €

Monocomando duche
single lever shower mixer
mitigeur monocommande douche
monomando mural ducha

157,70€

Cromado · chrome chrome · cromo	CT2512900	157,70 €
Preto · black noir · negro	CT2512905	189,30 €
Cores · colors couleurs · colores	CT25129 __	205,10 €
Metals · metals métaux · metales	CT25129 __	220,80 €



Trevi
Kit ducheta higiénica
Hygienic spray kit
Kit hygiénique
Kit ducheta higiénica

117,50€

Cromado · chrome chrome · cromo	CT2222300	117,50 €
Preto · black noir · negro	CT2222305	141,00 €
Cores · colors couleurs · colores	CT22223 __	152,80 €
Metals · metals métaux · metales	CT22223 __	164,50 €





Coluna de duche termostática
thermostatic shower column
colonne thermostatique de douche
columna termostática de ducha

390,00€

Cromado · chrome chrome · cromo	CT2521200	390,00 €
Preto · black noir · negro	CT2521205	468,00 €
Cores · colors couleurs · colores	C25212 __	507,00 €
Metals · metals métaux · metales	CT25212 __	546,00 €



Sistema de duche 1 via
shower system 1 way
système de douche 1 sortie
sistema de ducha 1 salida

187,60€

Cromado · chrome chrome · cromo	CT2255300	187,60 €
Preto · black noir · negro	CT2255305	225,10 €
Cores · colors couleurs · colores	CT22553 __	243,90 €
Metals · metals métaux · metales	CT22553 __	262,60 €



Sistema de duche 2 vias
shower system 2 ways
système de douche 2 sorties
sistema de ducha 2 salidas

338,70€

Cromado · chrome chrome · cromo	CT2255400	338,70 €
Preto · black noir · negro	CT2255405	406,40 €
Cores · colors couleurs · colores	CT22554 __	440,30 €
Metals · metals métaux · metales	CT22554 __	474,20 €



c/ desviador · w/ diverter
a/ déviateur · c/ desviador

Keen

A torneira Keen é um modelo com um design arrojado e extremamente dinâmico, idealizado para ambientes de requinte.

The Keen faucet is a model with a bold and extremely dynamic design, created for refined environments.

Le robinet Keen est un modèle au design audacieux et extrêmement dynamique, conçu pour des environnements raffinés.



Keen es un modelo con un diseño audaz y extremadamente dinámico, diseñado para ambientes refinados.



MONOCOMANDO LAVATÓRIO ALTO
HIGH BASIN MIXER
MITIGEUR LAVABO HAUT
MONOMANDO LAVABO ALTO



96,10€

BICA 200 MM

-  CT2511340 102,50 €
-  CT2511345 112,80 €
-  CT2511343 133,30 €

MONOCOMANDO LAVATÓRIO
BASIN MIXER
MITIGEUR LAVABO
MONOMANDO LAVABO

68,00€

-  CT2511300 68,00 €
-  CT2511305 74,80 €
-  CT2511303 88,40 €







MONOCOMANDO LAVATÓRIO DE ENCASTRAR DUO
 BUILT-IN BASIN MIXER DUO
 MITIGEUR LAVABO ENCASTRÉ DUO
 MONOMANDO LAVABO EMPOTRABLE DUO

Inclui box de encastrar
 Includes built-in box
 Comprend un boîtier encastré
 Incluye box para empotrar

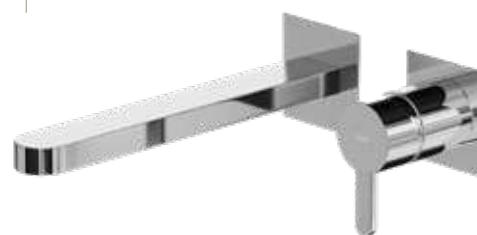

226,00€

	CT2713110	226,00 €
	CT2713115	272,10 €
	CT2713113	326,60 €



MONOCOMANDO BIDÉ
 BIDET MIXER
 MITIGEUR BIDET
 MONOMANDO BIDÉ

68,00€



	CT2511400	68,00 €
	CT2511405	74,80 €
	CT2511403	88,40 €



MONOCOMANDO LAVATÓRIO DE ENCASTRAR
 BUILT-IN BASIN MIXER
 MITIGEUR LAVABO ENCASTRÉ
 MONOMANDO LAVABO EMPOTRABLE

Inclui box de encastrar
 Includes built-in box
 Comprend un boîtier encastré
 Incluye box para empotrar

233,90€

	CT2713010	233,90 €
	CT2713015	281,60 €
	CT2713013	338,50 €





Chuveiro fixo em inox
Chuveiro de mão em latão
Bicha Giraflex



Fixed stainless steel showerhead
Brass handheld shower
Giraflex hose

Douche fixe en inox
Douchette en laiton
Flexible Giraflex

Rociador de acero inoxidable
Ducha de mano en latón
Flexible de ducha Giraflex

COLUNA DE DUCHE - 2 VIAS
SHOWER COLUMN - 2-WAY
COLONNE DE DOUCHE - 2 VOIES
MONOMANDO DUCHA - 2 SALIDAS



370,00€

-  CT2520600 370,00 €
-  CT2520605 444,00 €
-  CT2520603 518,00 €



MONOCOMANDO BANHEIRA
BATH MIXER
MITIGEUR BAIGNOIRE
MONOMANDO MURAL BAÑERA



217,60€

-  CT2511120 217,60€
-  CT2511125 239,40 €
-  CT2511123 282,90 €



MONOCOMANDO DUCHE
SHOWER MIXER
MITIGEUR DOUCHE
MONOMANDO DUCHA



166,10€

-  CT2511200 166,10 €
-  CT2511205 182,70 €
-  CT2511203 215,90 €



TERMOSTÁTICA DE DUCHE ROUND
ROUND SHOWER THERMOSTATIC MIXER
MITIGEUR THERMOSTATIQUE DOUCHE ROUND
TERMOSTÁTICO DE DUCHA ROUND

185,00€



-  CT2515250 185,00€
-  CT2515255 222,00 €
-  CT2515253 277,50 €





COLUNA DE DUCHE TERMOSTÁTICA - 2 VIAS
THERMOSTATIC SHOWER COLUMN - 2-WAY
COLONNE DE DOUCHE THERMOSTATIQUE - 2 VOIES
MONOMANDO DUCHA MURAL TERMOSTÁTICO - 2 SALIDAS

390,00€



-  CT2521200 390,00 €
-  CT2521205 468,00 €
-  CT2521203 546,00 €



SISTEMA DE DUCHE - 2 VIAS
SHOWER SYSTEM - 2-WAY
SYSTÈME DE DOUCHE - 2 VOIES
SISTEMA DE DUCHA - 2 SALIDAS

 C/ DESVIADOR
WITH DIVERTER
AVEC INVERSEUR



338,70€

-  CT2255100 338,70€
-  CT2255105 406,40 €
-  CT2255103 474,20 €



SISTEMA DE DUCHE - 1 VIA
SHOWER SYSTEM - 1-WAY
SYSTÈME DE DOUCHE - 1 VOIE
SISTEMA DE DUCHA - 1 SALIDA

187,60€

-  CT2255000 187,60 €
-  CT2255005 225,10 €
-  CT2255003 262,60 €



Spirit

A torneira Spirit apresenta-se com linhas leves e delicadas que são reflexo de um aprimorado espírito de inovação e de viver em pleno o espaço de banho. Com proporções equilibradas entre as linhas direitas que se diluem em suaves curvas.

A Spirit aporta elegância e modernidade ao seu espaço de banho.

The Spirit faucet features light and delicate lines that reflect a refined spirit of innovation and fully embracing the bathroom space. With balanced proportions between straight lines that flow into gentle curves. The Spirit brings elegance and modernity to your bathroom space.

Le robinet Spirit se présente avec des lignes légères et délicates qui reflètent un esprit raffiné d'innovation et de vivre pleinement l'espace de bain. Avec des proportions équilibrées entre des lignes droites qui se fondent en courbes douces.



La Spirit apporte élégance et modernité à votre espace de bain

El grifo Spirit presenta líneas suaves y delicadas, reflejo de un espíritu de innovación que busca mejorar la vida en el espacio de baño. Con proporciones equilibradas entre líneas rectas que se diluyen en curvas suaves. El grifo Spirit aporta elegancia y modernidad a tu baño.





MONOCOMANDO BIDÉ
BIDET MIXER
MITIGEUR BIDET
MONOMANDO BIDÉ

54,80€

-  CT2009220 54,80 €
-  CT2009225 60,30 €
-  CT2009223 71,20 €

MONOCOMANDO LAVATÓRIO ALTO
MONOMANDO LAVABO ALTO
HIGH BASIN MIXER
MITIGEUR LAVABO HAUT

98,80€



-  CT2009210 98,80 €
-  CT2009215 108,70 €
-  CT2009213 128,40 €





MONOCOMANDO LAVATÓRIO
BASIN MIXER
MITIGEUR LAVABO
MONOMANDO LAVABO



54,80€

-  CT2009200 54,80 €
-  CT2009205 60,30 €
-  CT2009203 71,20 €

MONOCOMANDO LAVATÓRIO DE ENCASTRAR DUO
BUILT-IN BASIN MIXER DUO
MITIGEUR LAVABO ENCASTRABLE DUO
MONOMANDO LAVABO EMPOTRABLE DUO

Inclui box de encastrar
Includes built-in box
Comprend un boîtier encastré
Incluye box para empotrar

162,40€



-  CT2713900 162,40 €
-  CT2713905 178,60 €
-  CT2713903 211,10 €



MONOCOMANDO LAVATÓRIO DE ENCASTRAR DUO
BUILT-IN BASIN MIXER
MITIGEUR LAVABO ENCASTRABLE
MONOMANDO LAVABO EMPOTRABLE

Inclui box de encastrar
Includes built-in box
Comprend un boîtier encastré
Incluye box para empotrar

170,80€

-  CT2713800 170,80 €
-  CT2713805 187,90 €
-  CT2713803 222,00 €





MONOCOMANDO BANHEIRA
BATH MIXER
MITIGEUR BAIGNOIRE
MONOMANDO BAÑERA

88,40€

CT2009230 88,40 €

CT2009235 97,20 €

CT2009233 114,90 €



MONOCOMANDO DUCHE
SHOWER MIXER
MITIGEUR DOUCHE
MONOMANDO DUCHA

67,80€

CT2009240 67,80 €

CT2009245 74,60 €

CT2009243 88,10 €



COLUNA DE DUCHE
SHOWER COLUMN
COLONNE DE DOUCHE
MONOMANDO LAVABO

226,00€

CT2404000 226,00 €

CT2404005 248,60 €

CT2404003 293,80 €



SISTEMA DE DUCHE - 1 VIA
SHOWER SYSTEM - 1-WAY
SYSTÈME DE DOUCHE - 1 VOIE
SISTEMA DE DUCHA - 1 SALIDA

C/ DESVIADOR

123,70€

CT2705200 123,70 €

CT2705205 136,10 €

CT2705203 160,80 €



SISTEMA DE DUCHE - 2 VIAS
SHOWER SYSTEM - 2-WAY
SYSTÈME DE DOUCHE - 2 VOIES
SISTEMA DE DUCHA - 2 SALIDAS

228,40€

CT2705300 228,40 €

CT2705305 251,20 €

CT2705303 296,90 €



móveis

espelhos

torneiras

acessórios
de banho

divisórias

bases e
banheiras

sistemas de
instalação

coleções
sanitárias

espaços
públicos

Focus



A torneira Focus não passa despercebida em nenhum espaço de banho. A sua forma tubular combinada com uma ligeira curvatura, tornam esta torneira num modelo de exemplo de linhas contemporâneas.

The Focus faucet does not go unnoticed in any bathroom space. Its tubular shape combined with a slight curve make this faucet an exemplary model of contemporary lines.

Le robinet Focus ne passe inaperçu dans aucun espace de bain. Sa forme tubulaire combinée à une légère courbure font de ce robinet un modèle exemplaire de lignes contemporaines.

El grifo Focus no pasa desapercibido en ningún espacio de baño. Su forma tubular combinada con sus curvas hace de este grifo un modelo ejemplar de líneas contemporâneas.



MONOCOMANDO LAVATÓRIO
BASIN MIXER
MITIGEUR LAVABO
MONOMANDO LAVABO

72,00€

CT2009000 72,00€



MONOCOMANDO BIDÉ
BIDET MIXER
MITIGEUR BIDET
MONOMANDO BIDÉ

72,00€

CT2009010 72,00€



MONOCOMANDO DUCHE
SHOWER MIXER
MITIGEUR DOUCHE
MONOMANDO DUCHA

88,00€

CT2009030 88,00€



MONOCOMANDO BANHEIRA
BATH MIXER
MITIGEUR BAIGNOIRE
MONOMANDO BAÑERA

116,00€

CT2009020 116,00€



Chuveiro fixo de aço inox
Fixed stainless steel shower
Douche fixe en acier inoxydable
Rociador en acero inoxidable

COLUNA DE DUCHE
SHOWER COLUMN
COLONNE DE DOUCHE

255,00€

CT2404202 255,00€



MONOCOMANDO CABELEIREIRO
HAIRDRESSER MIXER
MITIGEUR COIFFURE
MONOMANDO PELUQUERIA

112,00€

CT2009085 112,00€



Jazzy

A torneira Jazzy engloba na sua forma robusta um traço que lhe confere uma personalidade forte e moderna.

Está equipada com um cartucho de manuseamento suave que resulta num modelo que potencia o seu conforto no funcionamento quotidiano no espaço de banho.

The Jazzy faucet embodies, in its robust form, a feature that gives it a strong and modern personality.

It is equipped with a smooth-operation cartridge, resulting in a model that enhances your comfort in daily use within the bathroom space.

Le robinet Jazzy intègre, dans sa forme robuste, une touche qui lui confère une personnalité forte et moderne.

Il est équipé d'un cartouche à manipulation douce, offrant un modèle qui optimise votre confort dans l'utilisation quotidienne de l'espace de bain.

El grifo Jazzy incluye, en su forma robusta, un rasgo que le confiere una personalidad fuerte y moderna.

El cartucho de manejo suave de este modelo mejora la comodidad de tu baño. El sistema ECO ENERGY de los grifos CTESI te permite ahorrar energía, manteniendo todo el confort y funcionalidad.

MONOCOMANDO LAVATÓRIO DE ENCASTRAR
BUILT-IN BASIN MIXER
MITIGEUR LAVABO ENCASTRABLE
MONOMANDO LAVABO EMPOTRABLE

207,50€

CT2713410 207,50€



Inclui box de encastrar
Includes built-in box
Comprend un boîtier encastré
Incluye box para empotrar

MONOCOMANDO LAVATÓRIO DE ENCASTRAR DUO
BUILT-IN BASIN MIXER DUO
MITIGEUR LAVABO ENCASTRABLE DUO
MONOMANDO LAVABO EMPOTRABLE DUO

196,90€

CT2713510 196,90€

Inclui box de encastrar
Includes built-in box
Comprend un boîtier encastré
Incluye box para empotrar





MONOCOMANDO LAVATÓRIO
 BASIN MIXER
 MITIGEUR LAVABO
 MONOMANDO LAVABO

73,30€

CT2008700 73,30€

MONOCOMANDO BIDÉ
 BIDET MIXER
 MITIGEUR BIDET
 MONOMANDO BIDÉ

73,30€

CT2008710 73,30€

MONOCOMANDO LAVATÓRIO ALTO
 HIGH BASIN MIXER
 MITIGEUR LAVABO HAUT
 MONOMANDO LAVABO ALTO

142,90€

CT2008705 124,90€



móveis

espelhos

torneiras

acessórios
de banho

divisórias

bases e
banheiras

sistemas de
instalação

coleções
sanitárias

espaços
públicos



- Chuveiro inox
- Chuveiro de mão inox
- Bicha de duche cromada
- Rociador en acero inoxidable
- Ducha de mano en acero inoxidable
- Flexible de ducha cromado

Stainless steel shower
Stainless steel hand shower
Chrome shower hose
Duche inox
Douchette inox
Tuyau de douche chromé

MONOCOMANDO C/ CHUVEIRO FIXO EM INOX
MIXER WITH FIXED STAINLESS STEEL SHOWER
MITIGEUR AVEC DOUCHE FIXE EN INOX
MONOMANDO C/ROCIADOR FIJO DE ACERO INOXIDABLE

290,00€

CT2403902



MONOCOMANDO DE BANHEIRA
BATH MIXER
MITIGEUR BAIGNOIRE
MONOMANDO DE BAÑERA

120,70€

CT2008720



MONOCOMANDO DUCHE
SHOWER MIXER
MITIGEUR DOUCHE
MONOMANDO DUCHA

109,70€

CT2008730

Duchetas higiênicas



Duchas higiênicas • Hygienic hand showers • Douchettes hygiéniques



SQUARE

KIT DUCHETA C/ TORNEIRA DE ESQUADRIA
KIT DUCHETA C/ LLAVE DE ESCUADRA
HYGIENIC HAND SHOWER KIT WITH CORNER FAUCET
KIT DOUCHETTES HYGIÉNIQUES AVEC ROBINET D'ANGLE

72,50€



	CT2222600	72,50 €
	CT2222605	87,00 €
	CT2222603	101,50 €



SQUARE

KIT DUCHETA HIGIÉNICA LATÃO
KIT DUCHETA HIGIÉNICA
BRASS HYGIENIC HAND SHOWER KIT
KIT DOUCHETTE HYGIÉNIQUE EN LAITON

47,50€



	CT2222800	47,50 €
	CT2222805	57,00 €
	CT2222803	66,50 €



TREVI

KIT DUCHETA C/ TORNEIRA DE ESQUADRIA
KIT DUCHETA C/ LLAVE DE ESCUADRA
HYGIENIC HAND SHOWER KIT WITH CORNER FAUCET
KIT DOUCHETTES HYGIÉNIQUES AVEC ROBINET D'ANGLE

62,50€



	CT2222500	62,50 €
	CT2222505	75,00 €
	CT2222503	87,50 €



TREVI

KIT DUCHETA HIGIÉNICA LATÃO
KIT DUCHETA HIGIÉNICA
BRASS HYGIENIC HAND SHOWER KIT
KIT DOUCHETTE HYGIÉNIQUE EN LAITON

37,50€

	CT2222700	37,50 €
	CT2222705	45,00 €
	CT2222703	52,50 €





Colunas de duche

Columnas de ducha · Shower columns · Colonne de douche



Chuveiro fixo em inox
Rociador de acero inoxidable
Fixed stainless steel showerhead
Douche fixe en inox

ROUND MONOSENSE
COLUNA DE DUCHE MONOCOMANDO
COLUMN DUCHA MONOMANDO
OWER COLUMN
COLONNE DE DOUCHE

	CT2400520	280,00 €
	CT2400521	310,00 €
	CT2400523	400,00 €



Chuveiro fixo em inox
Rociador de acero inoxidable
Single-lever shower column
Colonne de douche à mitigeur monocommande

SQUARE MONOSENSE
COLUNA DE DUCHE MONOCOMANDO
COLUMN DUCHA MONOMANDO
OWER COLUMN
COLONNE DE DOUCHE

	CT2400720	290,00 €
	CT2400721	320,00 €
	CT2400723	410,00 €



Colunas termostáticas

Columnas de ducha termostáticas · Thermostatic shower columns · Colonnes de douche thermostatiques



Chuveiro fixo em inox
Fixed stainless steel showerhead
Douche fixe en inox
Rociador de acero inoxidable



ROUND THERMOSENSE
COLUNA DE DUCHE TERMOSTÁTICA
THERMOSTATIC SHOWER COLUMNS
COLONNES DE DOUCHE THERMOSTATIQUES
COLUMNA DUCHA TERMOSTÁTICA

	CT2400500	290,00 €
	CT2400501	320,00 €
	CT2400503	410,00 €



Chuveiro fixo em inox
Fixed stainless steel showerhead
Douche fixe en inox
Rociador de acero inoxidable

SQUARE THERMOSENSE
COLUNA DE DUCHE TERMOSTÁTICA
THERMOSTATIC SHOWER COLUMNS
COLONNES DE DOUCHE THERMOSTATIQUES
COLUMNA DUCHA TERMOSTÁTICA

	CT2400700	300,00 €
	CT2400701	330,00 €
	CT2400703	420,00 €

móveis

espelhos

torneiras

acessórios
de banho

divisórias

bases e
banheiras

sistemas de
instalação

coleções
sanitárias

espaços
públicos

Torneiras de Cozinha

Kitchen taps · Robinets de cuisine · Grifos de cocina





Plane
Monocomando de balcão
sink single lever mixer
mitigeur évier
mezclador fregadero

115,00€

Cromado · chrome chrome · cromo	CT2519800	115,00 €
Preto · black noir · negro	CT2519805	138,00 €
Cores · colors couleurs · colores	CT25198 __	150,00 €
Metais · metals métaux · metales	CT25198 __	165,00 €



Knobe
Monocomando de balcão
sink single lever mixer
mitigeur évier
mezclador fregadero

160,00€

Cromado · chrome chrome · cromo	CT2012200	160,00 €
Preto · black noir · negro	CT2012205	190,00 €
Cores · colors couleurs · colores	CT20122 __	210,00 €
Metais · metals métaux · metales	CT20122 __	230,00 €



Type
Monocomando de balcão
sink single lever mixer
mitigeur évier
mezclador fregadero

160,00€

Cromado · chrome chrome · cromo	CT2012100	160,00 €
Preto · black noir · negro	CT2012105	190,00 €
Cores · colors couleurs · colores	CT20121 __	210,00 €
Metais · metals métaux · metales	CT20121 __	230,00 €

Acabamentos · finishes · finitions · acabados



00
cromado
chrome
chromé
cromo



01
satinox



02
ouro
gold
or
oro



03
ouro escovado
brushed gold
or brossé
oro cepillado



04
ouro mate
matte gold
or mat
oro mate



05
preto mate
matte black
noir mat
negro mate



06
branco mate
matte white
blanc mat
blanco mate



07
grafite mate
graphite matte
graphite mat
grafito mate



08
bronze escovado
brushed bronze
bronze brossé
bronze cepillado



09
bronze
bronze
bronze
bronze



25
cashmere mate
matte cashmere
cashmere mat
cashmere mate



40
vermelho brilho
bright red
rouge briller
rojo brillo



42
azul brilho
bright blue
bleu briller
azul brillo



44
amarelo brilho
bright yellow
jaune briller
amarillo brillo

Cores · colors · couleurs · colores
06 · 07 · 25 · 40 · 42 · 44

Metais · metals · métaux · metales
01 · 02 · 03 · 04 · 08 · 09



SPIRIT
MONOCOMANDO BALCÃO
DECK-MOUNTED MIXER
MITIGEUR SUR PLAN
MEZCLADOR DE FREGADERO

96,00€

CT2009270



SPIRIT
MONOCOMANDO BALCÃO
DECK-MOUNTED MIXER
MITIGEUR SUR PLAN
MEZCLADOR DE FREGADERO

101,40€

CT2009260



KEEN
MONOCOMANDO BALCÃO
DECK-MOUNTED MIXER
MITIGEUR SUR PLAN
MEZCLADOR DE FREGADERO

BICA ALTA COM CHUVEIRO
HIGH SPOUT WITH HAND SHOWER
BEC HAUT AVEC DOUCHETTE
CAÑO ALTO CON DUCHA

143,30€

CT2003270



Type
Monocomando de balcão
sink single lever mixer
mitigeur évier
mezclador fregadero

170,00€

CT2002445



Plane
Monocomando de balcão
sink single lever mixer
mitigeur évier
mezclador fregadero

178,00€

CT2000645



ORION
MONOCOMANDO BALCÃO
DECK-MOUNTED MIXER
MITIGEUR SUR PLAN
MEZCLADOR DE FREGADERO

96,00€

CT2007855



ORION
MONOCOMANDO BALCÃO
DECK-MOUNTED MIXER
MITIGEUR SUR PLAN
MEZCLADOR DE FREGADERO

96,00€

CT2007860



ORION
MONOCOMANDO BALCÃO
DECK-MOUNTED MIXER
MITIGEUR SUR PLAN
MEZCLADOR DE FREGADERO

98,00€

CT2007845



FOCUS
MONOCOMANDO BALCÃO
DECK-MOUNTED MIXER
MITIGEUR SUR PLAN
MEZCLADOR DE FREGADERO

COM BICA RECLINÁVEL
WITH RECLINING SPOUT
AVEC BEC INCLINABLE
CAÑO ABATIBLE

110,00€

CT2009047

Sistemas de duche

CRIE
o seu
PRÓPRIO
SISTEMA
de **DUCHE**

Shower systems · Système de douche · Sistema de ducha

A Ctesi disponibiliza-lhe uma ampla gama de soluções para duchas embutidas - shower systems, que lhe permite obter múltiplas combinações e adaptá-las ao seu espaço de banho.

Create your own built-in shower system

Ctesi presents you a wide range of built-in shower systems, which allows you to get multiple combinations and adapt them to your bathroom.

Créez votre propre système de douche intégré

Ctesi vous présente une large gamme de systèmes de douche intégrés, ce qui vous permet d'obtenir de multiples combinaisons et de les adapter à votre salle de bains.

Crea tu propio sistema de ducha incorporado

Ctesi te presenta una amplia gama de soluciones para duchas empotradas - shower systems, que te permite obtener múltiples combinaciones y adaptarlas a tu espacio de baño.



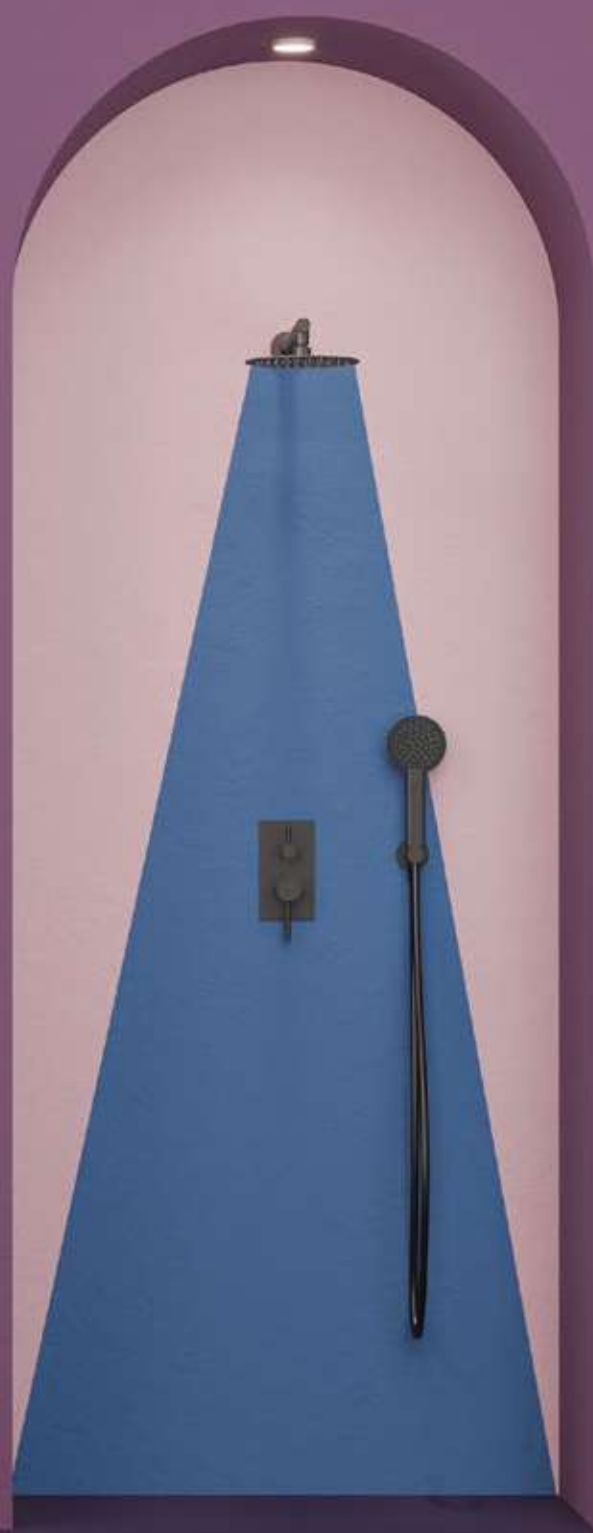

espaços
públicos

coleções
sanitárias

sistemas de
instalação

bases e
banheiras

divisórias

acessórios
de banho

torneiras

espelhos

móveis

Acabamentos · finishes · finitions · acabados



00
cromado
chrome
chromé
cromo



01
satinox



02
ouro
gold
or
oro



03
ouro escovado
brushed gold
or brossé
oro cepillado



04
ouro mate
matte gold
or mat
oro mate



05
preto mate
matte black
noir mat
negro mate



06
branco mate
matte white
blanc mat
blanco mate



07
grafite mate
graphite matte
graphite mat
grafito mate



08
bronze escovado
brushed bronze
bronze brossé
bronze cepillado



09
bronze
bronze
bronze
bronze



25
cashmere mate
matte cashmere
cashmere mat
cashmere mate



40
vermelho brilho
bright red
rouge briller
rojo brillo



42
azul brilho
bright blue
bleu briller
azul brillo



44
amarelo brilho
bright yellow
jaune briller
amarillo brillo

Cores · colors · couleurs · colores
06 · 07 · 25 · 40 · 42 · 44

Metais · metals · métaux · metales
01 · 02 · 03 · 04 · 08 · 09 · 10



Box monocomando de encastrar*
concealed box single lever mixer
box mitigeur monocommande encastrable
box monomando mural empotrable

Cromado · chrome
chrome · cromo CT2700000 73,70 €

Preto · black
noir · negro CT2700005 88,40 €

Cores · colors
couleurs · colores CT27000 __ 95,80 €

Metais · metals
métaux · metales CT27000 __ 103,20 €

1 saída · 1 way · 1 sortie · 1 salida



City
monocomando 1 via
single lever mixer 1 way
mitigeur monocommande 1 sortie
monomando 1 salida

Cromado · chrome
chrome · cromo CT2702100 52,70 €

Preto · black
noir · negro CT2702105 63,20 €

Cores · colors
couleurs · colores CT27021 __ 68,50 €

Metais · metals
métaux · metales CT27021 __ 73,80 €



Box monocomando de encastrar*
concealed box single lever mixer
box mitigeur monocommande encastrable
box monomando mural empotrable

Cromado · chrome
chrome · cromo CT2700100 87,70 €

Preto · black
noir · negro CT2700105 105,20 €

Cores · colors
couleurs · colores CT270010 __ 114,00 €

Metais · metals
métaux · metales CT270010 __ 122,80 €

1 saída · 1 way · 1 sortie · 1 salida



Plane
monocomando 1 via
single lever mixer 1 way
mitigeur monocommande 1 sortie
monomando 1 salida

Cromado · chrome
chrome · cromo CT2702300 52,70 €

Preto · black
noir · negro CT2702305 63,20 €

Cores · colors
couleurs · colores CT27023 __ 68,50 €

Metais · metals
métaux · metales CT27023 __ 73,80 €

* Inclui tela e tampa de proteção
includes waterproof membrane and protection cover
inclut une membrane d'imperméabilisation et un couvercle de protection
incluye membrana impermeabilizante y tapa de protección

no momento da encomenda deverá indicar a referência da box + a referência do modelo de torneira escolhido
at the time of ordering, you must indicate the reference box + reference model tap
au moment de la commande, vous devez indiquer la référence de la box + référence du modèle de robinet
en el momento de la encomienda deberá indicar la referencia de la box + la referencia del modelo de grifo.



Box monocomando de encastrar*
concealed box single lever mixer
box mitigeur monocommande encastrable
box monomando mural empotrable

	2 saídas · 2 ways 2 sorties · 2 salidas		3 saídas · 3 ways 3 sorties · 3 salidas	
Cromado · chrome chrome · cromo	CT2700200	112,30 €	CT2700300	119,30 €
Preto · black noir · negro	CT2700205	134,80 €	CT2700305	143,20 €
Cores · colors couleurs · colores	CT27002 __	146,00 €	CT27003 __	155,10 €
Metais · metals métaux · metales	CT27002 __	157,20 €	CT27003 __	167,00 €



Box monocomando de encastrar*
concealed box single lever mixer
box mitigeur monocommande encastrable
box monomando mural empotrable

	2 saídas · 2 ways 2 sorties · 2 salidas		3 saídas · 3 ways 3 sorties · 3 salidas	
Cromado · chrome chrome · cromo	CT2700400	126,30 €	CT2700500	136,80 €
Preto · black noir · negro	CT2700405	151,60 €	CT2700505	164,20 €
Cores · colors couleurs · colores	CT27004 __	164,20 €	CT27005 __	177,80 €
Metais · metals métaux · metales	CT27004 __	176,80 €	CT27005 __	191,50 €



City**
monocomando 2 vias
single lever mixer 2 ways
mitigeur monocommande 2 sorties
monomando 2 salidas

Cromado · chrome chrome · cromo	CT2702600	115,80 €
Preto · black noir · negro	CT2702605	139,00 €
Cores · colors couleurs · colores	CT27026 __	150,50 €
Metais · metals métaux · metales	CT27026 __	162,10 €



Plane
monocomando 2 vias
single lever mixer 2 ways
mitigeur monocommande 2 sorties
monomando 2 salidas

Cromado · chrome chrome · cromo	CT2702800	115,80 €
Preto · black noir · negro	CT2702805	139,00 €
Cores · colors couleurs · colores	CT27028 __	150,50 €
Metais · metals métaux · metales	CT27028 __	162,10 €

* Inclui tela e tampa de proteção
includes waterproof membrane and protection cover
includ une membrane d'imperméabilisation et un couvercle de protection
incluye membrana impermeabilizante y tapa de protección

** espelho e manipulador - com desviador
shower mixer - w/ diverter
mitigeur douche - a/ déviateur
monomando ducha - c/ desviador

no momento da encomenda deverá indicar a referência da box + a referência do modelo de torneira escolhido
at the time of ordering, you must indicate the reference box + reference model tap
au moment de la commande, vous devez indiquer la référence de la box + référence du modèle de robinet
en el momento de la encomienda deberá indicar la referencia de la box + la referencia del modelo de grifo.



Box monocomando de encastrar*
concealed box single lever mixer
box mitigeur monocommande encastrable
box monomando mural empotrable

	2 saídas · 2 ways 2 sorties · 2 salidas		3 saídas · 3 ways 3 sorties · 3 salidas	
Cromado · chrome chrome · cromo	CT2700900	273,60 €	CT2701000	291,20 €
Preto · black noir · negro	CT2700905	328,30 €	CT2701005	349,40 €
Cores · colors couleurs · colores	CT27009 __	355,70 €	CT27010 __	378,60 €
Metals · metals métaux · metales	CT27009 __	383,00 €	CT27010 __	407,70 €



City
Kit banheira / duche
bath / shower kit
kit baignoire / douche
kit bañera / ducha

	2 saídas · 2 ways 2 sorties · 2 salidas		3 saídas · 3 ways 3 sorties · 3 salidas	
	CT2715000	112,30 €	CT2715100	112,30 €
	CT2715005	134,80 €	CT2715105	134,80 €
	CT27150 __	146,00 €	CT27151 __	146,00 €
	CT27150 __	157,20 €	CT27151 __	157,20 €



City duo
Kit banheira / duche
bath / shower kit
kit baignoire / douche
kit bañera / ducha

	2 saídas · 2 ways 2 sorties · 2 salidas		3 saídas · 3 ways 3 sorties · 3 salidas	
	CT2715200	105,30 €	CT2715300	105,30 €
	CT2715205	126,40 €	CT2715305	126,40 €
	CT27152 __	136,90 €	CT27153 __	136,90 €
	CT27152 __	147,40 €	CT27153 __	147,40 €



Box monocomando de encastrar*
concealed box single lever mixer
box mitigeur monocommande encastrable
box monomando mural empotrable

	2 saídas · 2 ways 2 sorties · 2 salidas		3 saídas · 3 ways 3 sorties · 3 salidas	
Cromado · chrome chrome · cromo	CT2701100	315,70 €	CT2701200	333,20 €
Preto · black noir · negro	CT2701105	378,80 €	CT2701205	399,80 €
Cores · colors couleurs · colores	CT27011 __	410,40 €	CT27012 __	433,20 €
Metals · metals métaux · metales	CT27011 __	442,00 €	CT27012 __	466,50 €



Cube
Kit banheira / duche
bath / shower kit
kit baignoire / douche
kit bañera / ducha

	2 saídas · 2 ways 2 sorties · 2 salidas		3 saídas · 3 ways 3 sorties · 3 salidas	
	CT2715500	119,30 €	CT2715600	119,30 €
	CT2715505	143,20 €	CT2715605	143,20 €
	CT27155 __	155,10 €	CT27156 __	155,10 €
	CT27155 __	167,00 €	CT27156 __	167,00 €



Cube duo
Kit banheira / duche
bath / shower kit
kit baignoire / douche
kit bañera / ducha

	2 saídas · 2 ways 2 sorties · 2 salidas		3 saídas · 3 ways 3 sorties · 3 salidas	
	CT2715700	115,80 €	CT2715800	115,80 €
	CT2715705	139,00 €	CT2715805	139,00 €
	CT27157 __	150,50 €	CT27158 __	150,50 €
	CT27157 __	162,10 €	CT27158 __	162,10 €

* Inclui tela e tampa de proteção
includes waterproof membrane and protection cover
inclut une membrane d'imperméabilisation et un couvercle de protection
incluye membrana impermeabilizante y tapa de protección

no momento da encomenda deverá indicar a referência da box + a referência do modelo de torneira escolhido
at the time of ordering, you must indicate the reference box + reference model tap
au moment de la commande, vous devez indiquer la référence de la box + référence du modèle de robinet
en el momento de la encomienda deberá indicar la referencia de la box + la referencia del modelo de grifo.



Round kit haste com chuveiro - 200mm
round kit
round kit
round kit

Cromado · chrome
chrome · cromo CT2228500 89,30 €

Preto · black
noir · negro CT2228505 107,20 €

Cores · colors
couleurs · colores CT22285 __ 116,10 €

Metais · metals
métaux · metales CT22285 __ 125,00 €



Square kit haste com chuveiro - 200mm
square kit
square kit
square kit

Cromado · chrome
chrome · cromo CT2228700 97,80 €

Preto · black
noir · negro CT2228705 117,40 €

Cores · colors
couleurs · colores CT22287 __ 127,10 €

Metais · metals
métaux · metales CT22287 __ 136,90 €



Round kit Chuveiro
round shower kit
round kit douche
round kit ducha

Cromado · chrome
chrome · cromo CT2228600 71,00 €

Preto · black
noir · negro CT2228605 85,20 €

Cores · colors
couleurs · colores CT222865 __ 92,30 €

Metais · metals
métaux · metales CT222865 __ 99,40 €



Square kit Chuveiro
square shower kit
square kit douche
square kit ducha

Cromado · chrome
chrome · cromo CT2228800 78,30 €

Preto · black
noir · negro CT2228805 94,00 €

Cores · colors
couleurs · colores CT22288 __ 101,80 €

Metais · metals
métaux · metales CT22288 __ 109,60 €



Square cascade

Chuveiro parede de encastrar
wall mounted shower head
douche murale
rociador de ducha a pared

 CT2252050 550 x 220 390,00 €

aço inoxidável · stainless steel · acier inoxydable · acero inoxidable



Keen cascade

Chuveiro parede de encastrar
wall mounted shower head
douche murale
rociador de ducha a pared

 CT2252150 550 x 220 390,00 €

aço inoxidável · stainless steel · acier inoxydable · acero inoxidable



Cube

Chuveiro de encastrar teto
ceiling mounted shower head
douche de plafond encastrable
rociador empotrable de techo

 CT2251030 300 x 300 320,00 €

 CT2251040 400 x 400 420,00 €

 CT2251050 500 x 500 530,00 €

aço inoxidável · stainless steel · acier inoxydable · acero inoxidable



Rond

Chuveiro de encastrar teto
ceiling mounted shower head
douche de plafond encastrable
rociador empotrable de techo

 CT2251230 Ø 300 320,00 €

 CT2251240 Ø 400 420,00 €

 CT2251250 Ø 500 530,00 €

aço inoxidável · stainless steel · acier inoxydable · acero inoxidable



Square

Chuveiro fixo slim
slim shower head
douche de plafond slim
rociador slim

	250x250x2	300x300x2	400x400x2
Cromado · chrome chrome · cromo	CT2253100 64,70 €	CT2253200 89,60 €	CT2253300 154,80 €
Preto · black noir · negro	CT2253105 77,60 €	CT2253205 107,50 €	CT2253305 185,80 €
Cores · colors couleurs · colores	CT22531 __ 84,10 €	CT22532 __ 116,50 €	CT22533 __ 201,20 €
Metais · metals métaux · metales	CT22531 __ 90,60 €	CT22532 __ 125,40 €	CT22533 __ 216,70 €

aço inoxidável · stainless steel · acier inoxydable · acero inoxidable



Round

Chuveiro fixo slim
slim shower head
douche de plafond slim
rociador slim

	Ø 250x2	Ø 300x2	Ø 400x2
Cromado · chrome chrome · cromo	CT2253600 64,70 €	CT2253700 89,60 €	CT2253800 154,80 €
Preto · black noir · negro	CT2253605 77,60 €	CT2253705 107,50 €	CT2253805 185,80 €
Cores · colors couleurs · colores	CT22536 __ 84,10 €	CT22537 __ 116,50 €	CT22538 __ 201,20 €
Metais · metals métaux · metales	CT22536 __ 90,60 €	CT22537 __ 125,40 €	CT22538 __ 216,70 €

aço inoxidável · stainless steel · acier inoxydable · acero inoxidable



Cube
Haste de parede
wall mounted arm
bras mural
brazo a pared

Cromado · chrome chrome · cromo	CT2254000	59,70 €
Preto · black noir · negro	CT2254005	71,60 €
Cores · colors couleurs · colores	CT22540 __	77,60 €
Metals · metals métaux · metales	CT22540 __	83,60 €



Cube
Haste de teto
ceiling mounted arm
bras de plafond
brazo a techo

Cromado · chrome chrome · cromo	CT2254200	44,50 €
Preto · black noir · negro	CT2254205	53,40 €
Cores · colors couleurs · colores	CT22542 __	57,90 €
Metals · metals métaux · metales	CT22542 __	62,30 €



Cilin
Haste de parede
wall mounted arm
bras mural
brazo a pared

Cromado · chrome chrome · cromo	CT2254100	51,20 €
Preto · black noir · negro	CT2254105	61,40 €
Cores · colors couleurs · colores	CT22541 __	66,60 €
Metals · metals métaux · metales	CT22541 __	71,70 €

Cilin
Haste de teto
ceiling mounted arm
bras de plafond
brazo a techo

Cromado · chrome chrome · cromo	CT2254300	40,10 €
Preto · black noir · negro	CT2254305	48,10 €
Cores · colors couleurs · colores	CT22543 __	52,10 €
Metals · metals métaux · metales	CT22543 __	56,10 €



Cube
Jato lateral
body jets
jets latérales
jet de ducha

Cromado · chrome chrome · cromo	CT2254700	42,40 €
Preto · black noir · negro	CT2254705	50,90 €
Cores · colors couleurs · colores	CT22547 __	55,10 €
Metals · metals métaux · metales	CT22547 __	59,40 €



Cilin
Jato lateral
body jets
jets latérales
jet de ducha

Cromado · chrome chrome · cromo	CT2254800	35,60 €
Preto · black noir · negro	CT2254805	42,70 €
Cores · colors couleurs · colores	CT22548 __	46,30 €
Metals · metals métaux · metales	CT22548 __	49,80 €



Plane
Bica
spout
bec
caño

Cromado · chrome chrome · cromo	CT2250800	68,90 €
Preto · black noir · negro	CT2250805	82,70 €
Cores · colors couleurs · colores	CT22508 __	89,60 €
Metals · metals métaux · metales	CT22508 __	96,50 €



Cilin
Bica
spout
bec
caño

Cromado · chrome chrome · cromo	CT2250900	56,80 €
Preto · black noir · negro	CT2250905	68,20 €
Cores · colors couleurs · colores	CT22509 __	73,80 €
Metals · metals métaux · metales	CT22509 __	79,50 €



Cube
Tomada de água
wall outlet
coude mural
tomas de água

Cromado · chrome
chrome · cromo CT2254500 42,60 €

Preto · black
noir · negro CT2254505 51,10 €

Cores · colors
couleurs · colores CT22545 __ 55,40 €

Metals · metals
métaux · metales CT22545 __ 59,60 €



Cilin
Tomada de água
wall outlet
coude mural
tomas de água

Cromado · chrome
chrome · cromo CT2254600 37,60 €

Preto · black
noir · negro CT2254605 45,10 €

Cores · colors
couleurs · colores CT22546 __ 48,90 €

Metals · metals
métaux · metales CT22546 __ 52,60 €



Cube
Chuveiro de mão
hand shower
douchette
ducha

Cromado · chrome
chrome · cromo CT2221500 27,10 €

Preto · black
noir · negro CT2221505 32,50 €

Cores · colors
couleurs · colores CT22215 __ 35,20 €

Metals · metals
métaux · metales CT22215 __ 37,90 €



Cilin
Chuveiro de mão
hand shower
douchette
ducha

Cromado · chrome
chrome · cromo CT2221600 24,80 €

Preto · black
noir · negro CT2221605 29,80 €

Cores · colors
couleurs · colores CT22216 __ 32,20 €

Metals · metals
métaux · metales CT22216 __ 34,70 €



Giraflex 175cm
Bicha de chuveiro
shower hose
flexible de douche
flexible de ducha

Cromado · chrome
chrome · cromo CT2202000 13,60 €

Preto · black
noir · negro CT2202005 16,30 €

Cores · colors
couleurs · colores CT22020 __ 17,70 €

Metals · metals
métaux · metales CT22020 __ 19,00 €





1

Square monocomando
Kit ducheta higiénica
hygienic shower kit
kit douchete hygiénique
kit ducheta higienica

158,50€

Cromado · chrome
chrome · cromo CT2222400 158,50 €

Preto · black
noir · negro CT2222405 190,20 €

Cores · colors
couleurs · colores CT22224 __ 206,10 €

Metais · metals
métaux · metales CT22224 __ 221,90 €



2

Square esquadria
Kit ducheta higiénica
hygienic shower kit
kit douchete hygiénique
kit ducheta higienica

72,50€

Cromado · chrome
chrome · cromo CT2222600 72,50 €

Preto · black
noir · negro CT2222605 87,00 €

Cores · colors
couleurs · colores CT22226 __ 94,30 €

Metais · metals
métaux · metales CT22226 __ 101,50 €



3

Trevi monocomando
Kit ducheta higiénica
Hygienic spray kit
Kit hygiénique
Kit ducheta higienica

117,50€

Cromado · chrome
chrome · cromo CT2222300 117,50 €

Preto · black
noir · negro CT2222305 141,00 €

Cores · colors
couleurs · colores CT22223 __ 152,80 €

Metais · metals
métaux · metales CT22223 __ 164,50 €



4

Trevi esquadria
Kit ducheta higiénica
Hygienic spray kit
Kit hygiénique
Kit ducheta higienica

62,50€

Cromado · chrome
chrome · cromo CT2222500 62,50 €

Preto · black
noir · negro CT2222505 75,00 €

Cores · colors
couleurs · colores CT22225 __ 81,30 €

Metais · metals
métaux · metales CT22225 __ 87,50 €

Toalheiros e acessórios de banho

Toalleros y accesorios de baño
Towel rails and bathroom accessories
Porte-serviettes et accessoires de salle de bain

Os toalheiros e acessórios de banho CTESI são pensados para complementar o seu espaço com funcionalidade, personalidade e total harmonia.

A diversidade da coleção permite uma combinação perfeita com as linhas de torneiras e cabines CTESI, criando um ambiente coeso, equilibrado e elegante valorizando cada detalhe do espaço. Mais do que peças utilitárias, são elementos de design que acrescentam funcionalidade e sofisticação à sua casa de banho.

Los toalleros y accesorios de baño CTESI están diseñados para complementar tu espacio con funcionalidad, personalidad y total armonía.

La diversidad de la colección permite una combinación perfecta con las líneas de grifos y mamparas CTESI, creando un ambiente cohesionado, equilibrado y elegante que realza cada detalle del espacio.

Más que simples elementos utilitarios, son piezas de diseño que aportan funcionalidad y sofisticación a tu baño.

The CTESI towel rails and bathroom accessories are designed to complement your space with functionality, personality, and complete harmony.

The collection's variety allows a perfect match with CTESI's tapware and shower cabin lines, creating a cohesive, balanced, and elegant environment that highlights every detail of the space. More than just utilitarian pieces, they are design elements that add both functionality and sophistication to your bathroom.

Les porte-serviettes et accessoires de salle de bain CTESI sont conçus pour compléter votre espace avec fonctionnalité, personnalité et harmonie totale.

La diversité de la collection permet une combinaison parfaite avec les gammes de robinets et cabines CTESI, créant un environnement cohérent, équilibré et élégant, valorisant chaque détail de la pièce. Plus que de simples éléments utilitaires, ce sont des pièces de design qui ajoutent fonctionnalité et sophistication à votre salle de bain.

-
- 180. SMOOTH
 - 181. PIXEL
 - 182. DORY
 - 185. HOTEL



ctesi

espaços
públicos

coleções
sanitárias

sistemas de
instalação

bases e
banheiras

divisórias

acessórios
de banho

torneiras

espelhos

móveis

Smooth

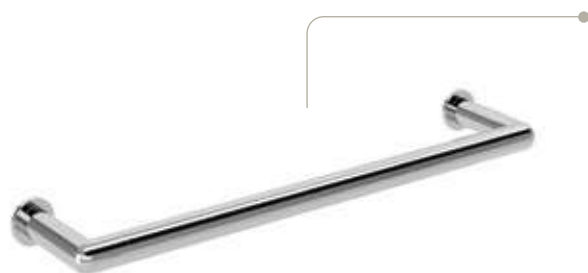

Toalheiro
towel rail
porte-serviettes
toallero

37,20 €

	300mm	450mm	600mm
Cromado · chrome chrome · cromo	CT1302000 37,20 €	CT1302100 43,70 €	CT1302200 48,60 €
Preto · black noir · negro	CT1302005 44,70 €	CT1302105 52,50 €	CT1302205 58,40 €
Cores · colors couleurs · colores	CT13020 __ 48,40 €	CT13021 __ 56,90 €	CT13022 __ 63,20 €
Metals · metals métaux · metales	CT13020 __ 52,10 €	CT13021 __ 61,20 €	CT13022 __ 68,10 €



Cabide
hook
crochet
percha

19,90 €

Cromado · chrome chrome · cromo	CT1301400	19,90 €
Preto · black noir · negro	CT1301405	23,90 €
Cores · colors couleurs · colores	CT13014 __	25,90 €
Metals · metals métaux · metales	CT13014 __	27,90 €



Porta rolo
toilet paper holder
porte-rouleau
portarollos

47,10€

Cromado · chrome chrome · cromo	CT1301300	47,10 €
Preto · black noir · negro	CT1301305	56,60 €
Cores · colors couleurs · colores	CT13013 __	61,30 €
Metals · metals métaux · metales	CT13013 __	66,00 €



Piaçaba
toilet brush
brosse de toilette
excobillero

69,50€

Cromado · chrome chrome · cromo	CT1300900	69,50 €
Preto · black noir · negro	CT1300905	83,40 €
Cores · colors couleurs · colores	CT13009 __	90,40 €
Metals · metals métaux · metales	CT13009 __	97,30 €

Pixel



Toalheiro
towel rail
porte-serviettes
toallero

49,30€

300mm

450mm

600mm

	300mm	450mm	600mm
Cromado · chrome chrome · cromo	CT1304000 49,30 €	CT1304100 53,40 €	CT1304200 56,70 €
Preto · black noir · negro	CT1304005 59,20 €	CT1304105 64,10 €	CT1304205 68,10 €
Cores · colors couleurs · colores	CT13040__ 64,10 €	CT13041__ 69,50 €	CT13042__ 73,80 €
Metais · metals métaux · metales	CT13040__ 69,10 €	CT13041__ 74,80 €	CT13042__ 79,40 €



Cabide
hook
crochet
percha

27,80€

Cromado · chrome chrome · cromo	CT1304400	27,80 €
Preto · black noir · negro	CT1304405	33,40 €
Cores · colors couleurs · colores	CT13044__	36,20 €
Metais · metals métaux · metales	CT13044__	39,00 €



Porta rolo
toilet paper holder
porte-rouleau
portarollos

53,40€

Cromado · chrome chrome · cromo	CT1304300	53,40 €
Preto · black noir · negro	CT1304305	64,10 €
Cores · colors couleurs · colores	CT13043__	69,50 €
Metais · metals métaux · metales	CT13043__	74,80 €



Piaçaba
toilet brush
brosse de toilette
excobillero

87,80€

Cromado · chrome chrome · cromo	CT1304900	87,80 €
Preto · black noir · negro	CT1304905	105,40 €
Cores · colors couleurs · colores	CT13049__	114,20 €
Metais · metals métaux · metales	CT13049__	123,00 €

Acabamentos · finishes · finitions · acabados



00
cromado
chrome
chromé
cromo



01
satinox



02
ouro
gold
or
oro



03
ouro escovado
brushed gold
or brossé
oro cepillado



04
ouro mate
matte gold
or mat
oro mate



05
preto mate
matte black
noir mat
negro mate



06
branco mate
matte white
blanc mat
blanco mate



07
grafite mate
graphite matte
graphite mat
grafito mate



08
bronze escovado
brushed bronze
bronze brossé
bronze cepillado



09
bronze
bronze
bronze
bronce



25
cashmere mate
matte cashmere
cashmere mat
cashmere mate



40
vermelho brilho
bright red
rouge briller
rojo brillo



42
azul brilho
bright blue
bleu briller
azul brillo



44
amarelo brilho
bright yellow
jaune briller
amarillo brillo

Cores · colors · couleurs · colores
06 · 07 · 25 · 40 · 42 · 44

Metais · metals · métaux · metales
01 · 02 · 03 · 04 · 08 · 09

Dory



TOALHEIRO
TOWEL RAIL
PORTE-SERVIETTES
TOALLERO

47,30 €

cm	POLIDO/PULIDO POLISHED/POLÍ	€
45	CT1310000	47,30
60	CT1310100	52,80
45	CT1310005	56,80
60	CT1310105	63,40
45	CT1310003	66,30
60	CT1310103	74,00



PORTA TOALHAS
TOWEL HOLDER
PORTE-SERVIETTES
TOALLERO

164,30 €

cm	POLIDO/PULIDO POLISHED/POLÍ	€
60	CT1310400	164,30
60	CT1310405	197,20
60	CT1310403	230,10



TOALHEIRO DUPLO
TOALLERO DOBLE
DOUBLE TOWEL RAIL
PORTE-SERVIETTES DOUBLE

64,30 €

cm	POLIDO/PULIDO POLISHED/POLÍ	€
60	CT1310300	64,30
60	CT1310305	77,20
60	CT1310303	90,10





CABIDE
HOOK
CROCHET
PERCHA

12,70 €

POLIDO/PULIDO POLISHED/POLÍ	€
CT1311200	12,70
CT1311205	15,30
CT1311203	17,80

PORTA ROLO C/ SUPORTE P/ SMARTPHONE
 TOILET PAPER HOLDER WITH SMARTPHONE STAND
 PORTE-ROULEAU AVEC SUPPORT POUR SMARTPHONE
 PORTAROLLOS C/SOPORTE P/ SMARTPHONE



37,80€

	POLIDO/PULIDO POLISHED/POLI	€
	CT1310600	37,80
	CT1310605	45,40
	CT1310603	53,00



PORTA ROLO
 TOILET PAPER HOLDER
 PORTE-ROULEAU
 PORTAROLLOS



26,20€

	POLIDO/PULIDO POLISHED/POLI	€
	CT1310500	26,20
	CT1310505	31,50
	CT1310503	36,70



SABONETEIRA
 SOAP HOLDER
 PORTE-SAVON
 JABONERA



39,80€

	POLIDO/PULIDO POLISHED/POLI	€
	CT1310900	39,80
	CT1310905	47,80
	CT1310903	55,80



SABONETEIRA DE CANTO
 CORNER SOAP HOLDER
 PORTE-SAVON D'ANGLE
 JABONERA DE ESQUINA

38,10€

	POLIDO/PULIDO POLISHED/POLI	€
	CT1311000	38,10
	CT1311005	45,80
	CT1311003	53,40

móveis

espelhos

torneiras

acessórios
de banho

divisórias

bases e
banheiras

sistemas de
instalação

coleções
sanitárias

espaços
públicos

Toalheiros para móveis • Towel holders for Cabinets
 Porte-serviettes pour meubles • Toalleros para muebles

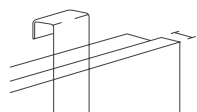
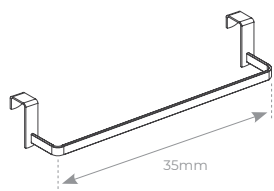

20mm



2,5 Kg

Toalheiro de pousar | Hanging towel rack | Porte-serviettes à suspendre
 | Toallero de apoyo



Cromado • chrome chrome • cromo	BL5550100	31,10 €
Cores • colors couleurs • colores	BL55501 __	42,40 €
Metals • metals métaux • metales	BL55501 __	53,30 €

Toalheiro auto-adesivo | Self-adhesive towel rack |
 Porte-serviettes auto-adhésif | Toallero autoadhesivo



Cromado • chrome chrome • cromo	BL5550200	32,70 €
Cores • colors couleurs • colores	BL55502 __	43,80 €
Metals • metals métaux • metales	BL55502 __	54,90 €



Hotel



Barra de apoio
Grab bar
Barre d'appui
barra de apoyo

40,50€

cm
30 CT1202500 40,50€
40 CT1202600 43,50€
50 CT1202700 48,50€

AISI 304



Piaçaba
toilet brush
brosse de toilette
escobillero

40,30€

A CHÃO SUELO CT1202460 40,30€
B PAREDE PARED CT1202465 48,50€

AISI 304



Barra de apoio com ângulo
Grab bar with angle
Barre d'appui avec angle
barra de apoyo angular

66,50€

CT1202650

AISI 304



Porta rolos simples
toilet paper holder
porte-rouleau
portarrollos

26,60€

CT1205620

AISI 304



SC1800
Secador de cabelo
Hair dryer
Sèche-cheveux
secador de pelo

84,10€

CT1205820

1800 W CLASSE II IPX0



Espelho telescópico
Telescopic mirror
Miroir télescopique
espejo telescópico

65,50€

CT1205160

COM AUMENTO 1X / 5X | CON AUMENTO 1X / 5X



móveis

espelhos

torneiras

acessórios
de banho

divisórias

bases e
banheiras

sistemas de
instalação

coleções
sanitárias

espaços
públicos

Divisórias de duche

Shower enclosures | Parois de douche | Mamparas de ducha

As divisórias de duche são muito mais do que um simples elemento da sua casa de banho – são a combinação perfeita entre design, conforto e funcionalidade. As inúmeras configurações disponíveis permitem aproveitar melhor o espaço, tornando-o mais funcional, moderno e elegante.

Na CTESI, estamos sempre um passo à frente, combinando inovação, qualidade e personalização. Oferecemos opções únicas e adaptadas às suas necessidades, com vidros temperados de alta qualidade – transparentes, foscos, serigrafados ou com impressão digital personalizada – e perfis em alumínio, assim como, acessórios em latão ou aço inox com diferentes acabamentos.

O resultado? Uma divisória de duche resistente, sofisticada e adaptada ao seu estilo, que transforma a sua casa de banho num espaço mais funcional, harmonioso e cheio de personalidade.

Escolha CTESI e descubra o perfeito equilíbrio entre estética e desempenho.

Les parois de douche sont bien plus qu'un simple élément de votre salle de bain – elles représentent la combinaison parfaite entre design, confort et fonctionnalité. Les nombreuses configurations disponibles permettent d'optimiser l'espace, le rendant plus fonctionnel, moderne et élégant.

Chez CTESI, nous sommes toujours un pas en avant, alliant innovation, qualité et personnalisation. Nous proposons des options uniques et adaptées à vos besoins, avec des verres trempés de haute qualité – transparents, mats, sérigraphiés ou avec impression numérique personnalisée – et des profils en aluminium, ainsi que des accessoires en laiton ou acier inoxydable avec différentes finitions.

Le résultat ? Une paroi de douche résistante, sophistiquée et adaptée à votre style, qui transforme votre salle de bain en un espace plus fonctionnel, harmonieux et plein de personnalité.

Choisissez CTESI et découvrez l'équilibre parfait entre esthétique et performance.

Shower enclosures are much more than just a simple element of your bathroom – they are the perfect combination of design, comfort, and functionality. The numerous available configurations allow you to make the most of the space, making it more functional, modern, and elegant.

At CTESI, we are always one step ahead, combining innovation, quality, and customization. We offer unique options tailored to your needs, with high-quality tempered glass – transparent, frosted, screen-printed, or with personalized digital printing – and aluminum profiles, as well as brass or stainless steel accessories in various finishes.

The result? A durable, sophisticated shower enclosure adapted to your style, transforming your bathroom into a more functional, harmonious, and personality-filled space.

Choose CTESI and discover the perfect balance between aesthetics and performance.

Las mamparas de ducha son mucho más que un simple elemento de su cuarto de baño: son la combinación perfecta de diseño, confort y funcionalidad. Las numerosas configuraciones disponibles permiten aprovechar mejor el espacio, haciéndolo más funcional, moderno y elegante.

En CTESI, siempre vamos un paso adelante, combinando innovación, calidad y personalización. Ofrecemos opciones únicas y adaptadas a sus necesidades, con vidrios templados de alta calidad – transparentes, satinados, serigrafiados o con impresión digital personalizada – y perfiles de aluminio, así como accesorios de latón o acero inoxidable con diferentes acabados.

¿El resultado? Una mampara de ducha resistente, sofisticada y adaptada a su estilo, que transforma su cuarto de baño en un espacio más funcional, armonioso y lleno de personalidad.

Elija CTESI y descubra el equilibrio perfecto entre estética y Rendimiento.



196. SLANT
200. CONTOUR
204. FIX
210. DEVA
224. BENT
228. MALU
234. VELA



espaços
públicos

coleções
sanitárias

sistemas de
instalação

bases e
banheiras

divisórias

acessórios
de banho

torneiras

espelhos

móveis



Personalização

Personalización | Customization | Personnalisation

Na Ctesi, transformamos ideias em realidade, criando cabines de duche feitas à medida de cada cliente. Do design à produção, cada detalhe é pensado com dedicação para garantir qualidade, funcionalidade e elegância.

Chez Ctesi, nous transformons les idées en réalité, créant des cabines de douche sur mesure pour chaque client. Du design à la production, chaque détail est pensé avec soin pour garantir qualité, fonctionnalité et élégance.

At Ctesi, we turn ideas into reality, creating custom-made shower enclosures tailored to each client. From design to production, every detail is thoughtfully crafted to ensure quality, functionality, and elegance.

En Ctesi, transformamos ideias em realidade, creando cabinas de ducha hechas a la medida de cada cliente. Desde el diseño hasta la producción, cada detalle es pensado con dedicación para garantizar calidad, funcionalidad y elegancia.



PROJETO CUSTOMIZADO

CUSTOM PROJECT
PROJET PERSONNALISÉ
PROYECTO PERSONALIZADO



ACABAMENTO DE VIDRO E PERFIL PERSONALIZADO

GLASS FINISH AND
CUSTOM PROFILE
FINITION EN VERRE ET
PROFIL PERSONNALISÉ
ACABADO DE VIDRIO Y
PERFIL PERSONALIZADO

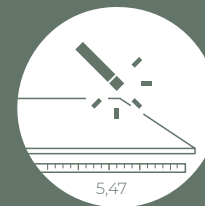

VIDRO TEMPERADO À SUA MEDIDA

TEMPERED GLASS
MADE TO YOUR SIZE
VERRE TREMPÉ À
VOTRE MESURE
VIDRIO TEMPLADO
A SU MEDIDA

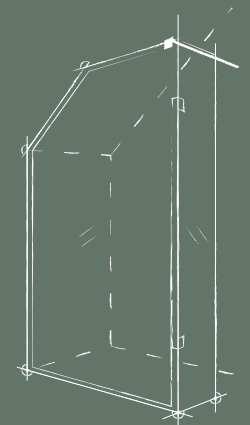
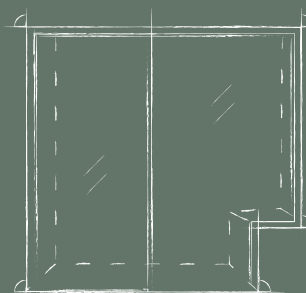
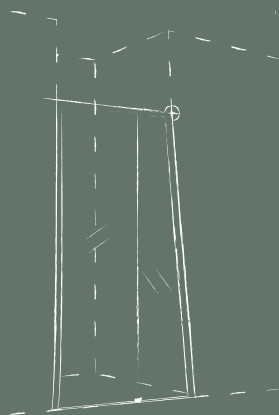

DESENHADO E FABRICADO EM
PORTUGAL

Acabamentos

Finishes · Finitions · Acabados



* verificar acabamentos disponíveis em cada modelo · check which finishes are available for each model
vérifier quelles finitions sont disponibles pour chaque modèle · consulta qué acabados hay disponibles para cada modelo



04
ouro mate
 matte gold
 or mat
 oro mate

05
preto mate
 matte black
 noir mat
 negro mate

06
branco mate
 matte white
 blanc mat
 blanco mate

07
grafite mate
 graphite matte
 graphite mat
 grafito mate

40
vermelho brilho
 bright red
 rouge briller
 rojo brillo

42
azul brilho
 bright blue
 bleu briller
 azul brillo

44
amarelo brilho
 bright yellow
 jaune briller
 amarillo brillo

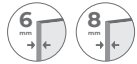

00
 transparente · transparent
 transparent · transparente



30
 fosco · fogged
 dépoli · fosco



50
 gris

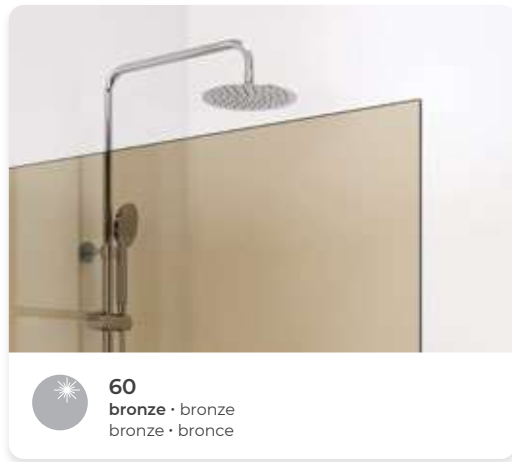

60
 bronze · bronze
 bronze · bronze



70
 canelado · fluted
 strié · canelado



40
 impressão digital - quadrados
 digital printing - squares
 impression numérique - carrés
 impresión digital - cuadrados



41
 impressão digital - retângulos
 digital printing - rectangles
 impression numérique - rectangles
 impresión digital - rectángulos



42
 impressão digital - branco
 digital printing - white
 impression numérique - blanche
 impresión digital - blanco

Vidros serigrafados

screen printed glasses · verres sérigraphiés · cristales serigrafiados



10 · 11 * · 12 **

Alpha

serigrafado · serigraphed
serigraphié · serigrafado



13 · 14 * · 15 **

Beta

serigrafado · serigraphed
serigraphié · serigrafado



16 · 17 * · 18 **

Omega

serigrafado · serigraphed
serigraphié · serigrafado

* **Direito** · right · droite · derecho

** **Esquerdo** · left · gauche · izquierdo

Easy clean



vidro normal · normal glass
verre normal · cristal normal



vidro easy clean · easy clean glass
verre easy clean · cristal easy clean

móveis

espelhos

torneiras

acessórios
de banho

divisórias

bases e
banheiras

sistemas de
instalação

coleções
sanitárias

espaços
públicos

Cabines retangulares

Nestes casos, o que establece a posición da serigrafía a Dereita ou à Esquerda é a medida maior. Exemplo com a mesma medida 70 x 90 cm:

Rectangular shower enclosures

In this case, what sets the position of the screen printing on the right or the left, is the largest measure. Example with the same measure 70x90 cm:

Cabines de douche rectangulaires

Dans ces cas, c'est la plus grande mesure qui établit la position de la sérigraphie à droite ou à gauche. Exemple avec la même mesure 70x90 cm:

Mamparas rectangulares

En este caso, lo que establece la posición de la serigrafía a la derecha o izquierda es la medida más grande. Ejemplo con la misma medida 70x90 cm:

Cabines quadradas

Nestes casos, o que establece a posición da serigrafía à Dereita ou à Esquerda é o lado com porta ou com fixo + porta. Exemplo com a mesma medida 70 x 70 cm:

Square shower enclosures

In this case, what sets the position of the screen printing on the right or the left, is the side with door or fixed panel with door. Example with the same measure 70x70 cm:

Cabines de douche carrés

Dans ces cas, ce qui établit la position de la sérigraphie à droite ou à gauche c'est le côté avec porte ou fixe plus porte. Exemple avec la même mesure 70x70 cm:

Mamparas cuadradas

En este caso, lo que establece la posición de la serigrafía a la derecha o izquierda es el lado con puerta o con fijo + puerta. Ejemplo con la misma medida 70x70 cm:

Frontais de duche

Nestes casos, o que establece a posición da serigrafía à Dereita ou à Esquerda é a posición da porta, ou a sua fixação nos modelos com portas a abrir para o exterior. Exemplo com a mesma medida 160 cm:

Shower panels

In the case of sliding doors, what sets the position of the screen printing is the position of the door. Example with the same measure 160 cm:

Paroi de douche

Dans ce cas, ce qui établit la position de la sérigraphie à droite ou à gauche c'est la position de la porte ou sa fixation dans les modèles avec portes s'ouvrant vers l'extérieur. Exemple avec la même mesure 160 cm:

Mamparas de duche

En este caso, lo que establece la posición de la serigrafía a la derecha o izquierda es la posición de la puerta o su fijación en los modelos de apertura de puertas para el exterior. Ejemplo con la misma medida 160 cm:

Serigrafia esquerda · Left screen painting
Sérigraphie gauche · Serigrafia izquierda

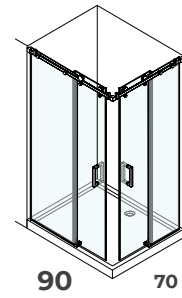

◀ **70 x 90 cm**
esquerda · left · gauche · izquierda

Serigrafia direita · Right screen painting
Sérigraphie droite · Serigrafia derecha

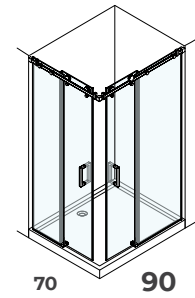

▶ **70 x 90 cm**
direita · right · droite · derecha

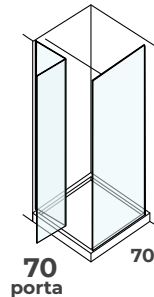

◀ **70 x 70 cm**
esquerda · left · gauche · izquierda

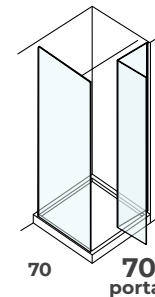

▶ **70 x 70 cm**
direita · right · droite · derecha

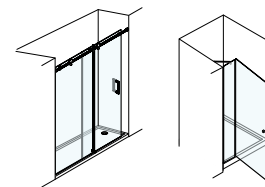

porta · door · porte · puerta

◀ **160 cm**
esquerda · left · gauche · izquierda

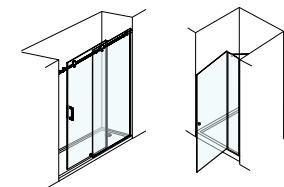

porta · door · porte · puerta

▶ **160 cm**
direita · right · droite · derecha

esquerda
left
gauche
izquierda



direita
right
droite
derecha

O código é composto por 5 dígitos que correspondem à cabine, mais 2 dígitos que correspondem aos acabamentos do vidro, mais 2 dígitos que correspondem ao acabamento das dobradiças ou perfis de metal.

Para escolher os acabamentos da sua cabine siga a seguinte regra:

The code consists of 5 digits corresponding to the enclosure, plus 2 digits corresponding to the glass finishes, plus 2 digits corresponding to the finish of the hinges or metal profiles.

To choose the finishes for your enclosure, follow this rule:

Le code est composé de 5 chiffres correspondant à la cabine, plus 2 chiffres correspondant aux finitions du verre, plus 2 chiffres correspondant à la finition des charnières ou des profilés métalliques.

Pour choisir les finitions de votre cabine, suivez la règle suivante :

El código está compuesto por 5 dígitos que corresponden a la cabina, más 2 dígitos que corresponden a los acabados del vidrio, más 2 dígitos que corresponden al acabado de las bisagras o perfiles de metal.

Para elegir los acabados de su cabina, siga la siguiente regla:

30100



**Código da cabine
(apresentado na tabela de preços)**

Shower enclosure code
(presented in the price list)

code de cabine de douche
(présent dans la liste de prix)

código de la mampara
(presente en la lista de precios)

00



**Código de acabamento do vidro
(disponível na página 192)**

glass finish code
(available on page 192)

code de finition du verre
(disponible à la page 192)

código de acabado del vidrio
(disponible en la página 192)

00



**Código de acabamento do metal
(disponível na página 190)**

metal finish code
(available on page 190)

code de finition du métal
(disponible à la page 190)

código del acabado del metal
(disponible en la página 190)

Slant



Painel de douche Walk-In | 1 porta + 1 painel fixo | Vidro transparente | Perfil preto mate
Walk-In shower panel | 1 door + 1 fixed panel | Transparent glass | Matte black frame
Paroi de douche Walk-In | 1 porte + 1 panneau fixe | Verre transparent | Profil noir mat
Mampara ducha walk-in | 1 puerta + 1 panel fijo | Cristal transparente | Perfil negro mate



Frontal duche | 1 fixo + 1 porta | Vidro transparente | Perfil cromado
Shower front | 1 fixed panel + 1 door | Transparent glass | Chrome frame
Façade de douche | 1 fixe + 1 porte | Verre transparent | Profil chromé
Mampara ducha frontal | 1 puerta + 1 panel fijo | Cristal transparente | Perfil cromo

móveis

espelhos

torneiras

acessórios
de banho

divisórias

bases e
banheiras

sistemas de
instalação

coleções
sanitárias

espaços
públicos

Frontal de duche 1 Porta + 1 Fixo

Shower front 1 door + 1 fixed panel
Façade de douche 1 porte + 1 panneau fixe
Frontal de ducha 1 puerta + 1 fijo

cm	REF	€ *
100	31000 _ _ _ _	415,00 €
110	31001 _ _ _ _	430,00 €
120	31002 _ _ _ _	450,00 €
130	31003 _ _ _ _	465,00 €
140	31004 _ _ _ _	505,00 €
150	31005 _ _ _ _	530,00 €
160	31006 _ _ _ _	550,00 €
170	31007 _ _ _ _	570,00 €
180	31008 _ _ _ _	595,00 €

Frontal walk-in 1 Porta + 1 Fixo

Walk-in front 1 door + 1 fixed panel
Façade walk-in 1 porte + 1 panneau fixe
Frontal walk-in 1 puerta + 1 fijo

cm	REF	€ *
100	31010 _ _ _ _	440,00 €
110	31011 _ _ _ _	460,00 €
120	31012 _ _ _ _	475,00 €
130	31013 _ _ _ _	495,00 €
140	31014 _ _ _ _	535,00 €
150	31015 _ _ _ _	555,00 €
160	31016 _ _ _ _	575,00 €
170	31017 _ _ _ _	595,00 €
180	31018 _ _ _ _	620,00 €

Painel lateral

Side panel
Panneau latéral
Panel lateral

cm	REF	€ *
70	31020 _ _ _ _	155,00 €
75	31021 _ _ _ _	155,00 €
80	31022 _ _ _ _	160,00 €
85	31023 _ _ _ _	165,00 €
90	31024 _ _ _ _	170,00 €

Cores de perfil · profile colors
couleurs de profil · colores de perfil

	Cromado · Chrome Chromé · Cromo	
	Preto · Black Noir · Negro	+ 20 %
	Cores · Colors Couleurs · Colores	+ 30 %
	Metais · metals métaux · metales	+ 40 %

Opções de vidro · opciones de cristal
glass options · Options de verre

cm	serigrafado serigrafia screen printed sérigraphié	fosco mate frosted mat	gris/bronze gris/bronze gris/bronze	impressão digital digital printing impression numérique impresión digital
≤ 100	+ 30 €	+ 100 €	+ 150 €	+ 250 €
101 - 200	+ 60 €	+ 200 €	+ 300 €	+ 500 €
201-300	+ 90 €	+ 300 €	+ 450 €	+ 750 €



 **Avisos** · warning
avertissements · avisos

Altura máxima · maximum height Hauter maximale · Altura máxima	220cm
Largura máxima · Maximum width Largeur maximale · Anchura máxima	220cm

Códigos · codes · codes · códigos :

acabamentos vidro glass finishes finitions verre acabados cristal	acabamentos metal metal finishes finitions métal acabados metal
---	---

Pág. 192

Pág. 190



Espessura do vidro
Glass thickness
Épaisseur du verre
Espesor del cristal



Vídeos c/ outros acabamentos
Glass with other finishes
Verres avec d'autres finitions
Cristal con otros acabados



Limpeza fácil
Easy clean
Facile à nettoyer
Fácil limpieza



Reversível**
Réversible
Réversible
Reversible



2m altura
2m height
2m hauteur
2m altura



Haste de fixação incluída
Fixing rod included
Tige de fixation incluse
Varilla de fijación incluida

* Preço para perfil cromado e vidro transparente · Price for chromed profile and transparente glass · Prix pour profil chromé et verre transparent · Precio para perfil cromo y cristal transparente

** Reversível somente para vidro transparente · Reversible for transparent glass only · Réversible uniquement pour verre transparent · Reversible solo para vidrio transparente



Frontal duche | 1 porta + 1 painel fixo + 1 painel fixo lateral | Vidro transparente | Perfil ouro
Shower front | 1 door + 1 fixed panel + 1 fixed side panel | Transparent glass | Gold frame
Frontal de douche | 1 porte + 1 panneau fixe + 1 panneau fixe latéral | Verre transparent | Profil or
Mampara ducha frontal | 1 puerta + 1 panel fijo + 1 panel fijo lateral | Cristal transparente | Perfil oro

Contour



Painel de douche Walk-In | Vidro transparente | Toalheiro e perfil branco mate
Walk-In shower panel | Transparent glass | Towel rail and matte white profile
Panneau de douche Walk-In | Verre transparent | Porte-serviettes et profil blanc mat
Mampara ducha frontal walk-in | Cristal transparente | Toallero y perfil blanco mate

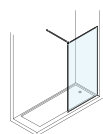

Painel de duche Walk-In | Vidro canelado | Perfil e haste de fixação ouro
Walk-In shower panel | Ribbed glass | Gold profile and fixing rod
Panneau de douche Walk-In | Verre cannelé | Profilé et barre de fixation or
Mampara ducha | Cristal acanalado | Varilla de fijación y perfil oro

Painel walk-in 200cm · Walk-in panel
 Panneau walk-in · Panel walk-in

(H)

cm	REF	€*
70	30300 _ _ _ _	370,00 €
80	30301 _ _ _ _	410,00 €
90	30302 _ _ _ _	445,00 €
100	30303 _ _ _ _	485,00 €
110	30304 _ _ _ _	525,00 €
120	30305 _ _ _ _	565,00 €
130	30306 _ _ _ _	600,00 €
140	30307 _ _ _ _	640,00 €
150	30308 _ _ _ _	675,00 €

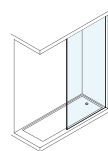
Painel walk-in 240cm · Walk-in panel
 Panneau walk-in · Panel walk-in

cm	REF	€*
70	30310 _ _ _ _	420,00 €
80	30311 _ _ _ _	460,00 €
90	30312 _ _ _ _	505,00 €
100	30313 _ _ _ _	550,00 €
110	30314 _ _ _ _	600,00 €
120	30315 _ _ _ _	645,00 €
130	30316 _ _ _ _	690,00 €
140	30317 _ _ _ _	735,00 €
150	30318 _ _ _ _	780,00 €

Cores de perfil · profile colors
 couleurs de profil · colores de perfil

10	Cromado · Chrome Chromé · Cromo	
10	Preto · Black Noir · Negro	+ 20 %
20	Cores · Colors Couleurs · Colores	+ 30 %
25	Metais · metals métaux · metales	+ 40 %

Opções de toalheiros · towel rail options
 option de porte-serviettes · opciones de toallero

10	Cromado · Chrome Chromé · Cromo	125 €
10	Preto · Black Noir · Negro	+ 20 %
20	Cores · Colors Couleurs · Colores	+ 30 %
25	Metais · metals métaux · metales	+ 40 %

Varição de medidas · size variation
 variation des mesures · variación de medidas

Cada 10cm (altura/largura) acrescentar
 Add every 10 cm (height/width) 30 €
 Ajouter tous les 10cm (hauteur/largeur)
 Cada 10cm (altura/ancha) aumentar

Opções de vidro · opciones de cristal
 glass options · Options de verre

cm	serigrafado serigrafia screen printed sérigraphié	fosco mate frosted mat	gris/bronze gris/bronze gris/bronze gris/bronze	impressão digital digital printing impression numérique impresión digital	canelado fluted cannelé acanalado
≤ 100	+ 20 €	+ 100 €	+ 120 €	+ 220 €	+ 220 €
101 - 200	+ 20 €	+ 200 €	+ 220 €	+ 380 €	+ 380 €

10
25

Códigos · codes · codes · códigos :

acabamentos vidro glass finishes finishions verre acabados cristal	acabamentos metal metal finishes finishions métal acabados metal
---	---

Pág. 192

Pág. 190



Espessura do vidro
 Glass thickness
 Épaisseur du verre
 Espesor del cristal



Vidros c/ outros acabamentos
 Glass with other finishes
 Verres avec d'autres finitions
 Cristal con otros acabados



Limpeza fácil
 Easy clean
 Facile à nettoyer
 Fácil limpieza



Reversível
 Réversible
 Réversible
 Reversible



Haste de fixação incluída
 Fixing rod included
 Tige de fixation incluse
 Varilla de fijación incluida

* Preço para perfil cromado e vidro transparente · Price for chromed profile and transparente glass · Prix pour profil chromé et verre transparente · Precio para perfil cromo y cristal transparente



Painel de duche Walk-In | Haste fixação e perfil cromado | Vidro transparente
Walk-In shower panel | Transparent glass | Chrome fixing rod and profile
Panneau de douche Walk-In | Verre transparent | Barre de fixation et profilé chromé
Mampara ducha frontal walk-in | Varilla de fijación y perfil cromo | Cristal transparente

móveis

espelhos

torneiras

acessórios
de banho

divisórias

bases e
banheiras

sistemas de
instalação

coleções
sanitárias

espaços
públicos

Fix



Painel de ducha Walk-In | Vidro gris | Haste fixaç o Row e Perfil preto mate
Mampara ducha frontal walk-in | Cristal gris | Varilla de fijaci n Row y Perfil negro mate
Walk-In shower panel | Grey glass | Row fixing rod and matt black profile
Panneau de douche Walk-In | Verre gris | Tige de fixation Row et Profil  noir mat



Painel de duche Walk-In | Vidro impressão digital branco | Haste fixação Row e perfil dourado
Walk-In shower panel | White digital print glass | Row fixing rod and golden profile
Panneau de douche Walk-In | Verre impression digitale blanc | Tige de fixation Row et profil doré
Mampara ducha frontal walk-in | Cristal impresión digital - blanco | Varilla de fijación Row y Perfil oro

móveis

espelhos

torneiras

acessórios
de banho

divisórias

bases e
banheiras

sistemas de
instalação

coleções
sanitárias

espaços
públicos



Painel de duche Walk-In | Vidro impressão digital preto | Haste fixação Row e perfil em preto mate
Walk-In shower panel | Black digital print glass | Row fixing rod and matte black profile
Panneau de douche Walk-In | Verre impression digitale noir | Tige de fixation Row et profil en noir mat
Mampara ducha frontal walk-in | Cristal impresión digital - negro | Varilla de fijación Row y perfil en negro mate



Painel de duche Walk-In | 1 painel fixo + 1 painel móvel | Vidro transparente | Haste fixação Row e Perfil ouro
Walk-In shower panel | 1 fixed panel + 1 movable panel | Transparent glass | Row fixing rod and gold profile
Panneau de douche Walk-In | 1 panneau fixe + 1 panneau mobile | Verre transparent | Tige de fixation Row et profil or
Mampara ducha frontal walk-in | 1 panel fijo + 1 panel practicable | Cristal transparente | Varilla de fijación Row y Perfil oro

móveis

espelhos

torneiras

acessórios
de banho

divisórias



bases e
banheiras

sistemas de
instalação

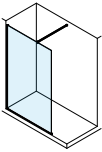

coleções
sanitárias

espaços
públicos

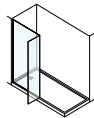

Painel walk-in 8mm · Walk-in panel
 Panneau walk-in · Panel walk-in

	cm	Ajuste adjustment réglage ajuste	REF	€ *
	70	69 70	30800 _ _ _ _	225,00 €
	80	79 80	30801 _ _ _ _	250,00 €
	90	89 90	30802 _ _ _ _	270,00 €
	100	99 100	30803 _ _ _ _	290,00 €
	110	109 110	30804 _ _ _ _	320,00 €
	120	119 120	30805 _ _ _ _	345,00 €
	130	129 130	30806 _ _ _ _	365,00 €
	140	139 140	30807 _ _ _ _	385,00 €
	150	149 150	30808 _ _ _ _	410,00 €

Painel walk-in 1 porta + 1 fixo 6mm · Walk-in panel 1 door + 1 fixed
 Panneau walk-in 1 porte + 1 fixe · Panel walk-in 1 puerta + 1 fijo



	cm	Ajuste adjustment réglage ajuste	Painel fixo fixed panel panneau fixe panel fijo	Aba flap Rabat aba	REF	€ *
	100	98,5 100	70	30	30560 _ _ _ _	440,00 €
	110	108,5 110	80	30	30561 _ _ _ _	470,00 €
	120	118,5 120	90	30	30562 _ _ _ _	500,00 €
	130	128,5 130	100	30	30563 _ _ _ _	520,00 €
	140	138,5 140	110	30	30564 _ _ _ _	550,00 €
	150	148,5 150	120	30	30565 _ _ _ _	570,00 €

Cores de perfil · profile colors
 couleurs de profil · colores de perfil

 Cromado · Chrome Chromé · Cromo	
 Preto · Black Noir · Negro	+ 20 %
 Cores · Colors Couleurs · Colores	+ 30 %
 Metais · metals métaux · metales	+ 40 %

Opções de vidro · opciones de cristal
 glass options · Options de verre

cm	serigrafado serigrafia screen printed sérigraphié	fosco mate frosted mat	gris/bronze gris/bronze gris/bronze	impressão digital digital printing impression numérique impresión digital	canelado fluted cannelé acanalado
≤ 100	+ 20 €	+ 100 €	+ 120 €	+ 220 €	+ 220 €
101 - 200	+ 20 €	+ 200 €	+ 220 €	+ 380 €	+ 380 €
					

 **Avisos** · warning
 avertissements · avisos

Altura máxima · maximum height Hauter maximale · Altura máxima	240cm
Largura máxima · Maximum width Largueur maximale · Anchura máxima	200cm

Variação de medidas · size variation
 variation des mesures · variación de medidas

Cada 10cm (altura/largura) acrescentar Add every 10 cm (height/width) Ajouter tous les 10cm (hauteur/largeur) Cada 10cm (altura/anchura) aumentar	30 €
---	------

Códigos · codes · codes · códigos :

acabamentos vidro glass finishes finitions verre acabados cristal	acabamentos metal metal finishes finitions métal acabados metal
---	---

Pág. 192

Pág. 190

Vidros c/ outros acabamentos
 Glass with other finishes
 Verres avec d'autres finitions
 Cristal con otros acabados

Limpeza fácil
 Easy clean
 Facile à nettoyer
 Fácil limpieza

Reversível **
 Réversible
 Réversible
 Reversible

2m altura
 2m height
 2m hauteur
 2m altura

Haste de fixação incluída
 Fixing rod included
 Tige de fixation incluse
 Varilla de fijación incluida

* Preço para perfil cromado e vidro transparente · Price for chromed profile and transparente glass · Prix pour profil chromé et verre transparent · Precio para perfil cromo y cristal transparente

** Reversível somente para vidro transparente · Reversible for transparent glass only · Réversible uniquement pour verre transparent · Reversible solo para vidrio transparente



Painel de duche Walk-In | Vidro canelado | Haste fixação Row e perfil cromado
Mampara ducha frontal walk-in | Cristal acanalado | Varilla fijación Row y perfil cromado
Walk-In shower panel | Ribbed glass | Row fixing rod and chrome profile
Panneau de douche Walk-In | Verre cannelé | Tige de fixation Row et profil chromé

móveis

espelhos

torneiras

acessórios
de banho

divisórias

bases e
banheiras

sistemas de
instalação

coleções
sanitárias

espaços
públicos

Deva



Cabine duche | 2 portas + 2 painéis fixos | Vidro transparente | Fecho magnético | Haste fixação Angle (2x) e perfil preto mate
Shower cabin | 2 doors + 2 fixed panels | Transparent glass | Magnetic closure | Angle fixing rod (2x) and matte black profile
Cabine de douche | 2 portes + 2 panneaux fixes | Verre transparent | Fermeture magnétique | Barre de fixation Angle (2x) et profil noir mat
Mampara ducha | 2 puertas + 2 paneles fijos | Cristal transparente | Cierre magnético | Varilla de fijación Angle(2x) y perfil negro mate



Cabine duche | 1 porta + 2 painéis fixos | Vidro transparente | Fecho magnético | Haste fixação Angle (2x) e perfil ouro
Shower cabin | 1 door + 2 fixed panels | Transparent glass | Magnetic closure | Angle fixing rod (2x) and gold profile
Cabine de douche | 1 porte + 2 panneaux fixes | Verre transparent | Fermeture magnétique | Barre de fixation Angle (2x) et profil or
Mampara ducha | 2 puertas + 2 paneles fijos | Cristal transparente | Cierre magnético | Varilla de fijación Angle (2x) y perfil oro

móveis

espelhos

torneiras

acessórios
de banho

divisórias

bases e
banheiras

sistemas de
instalação

coleções
sanitárias

espaços
públicos



Frontal duche | 2 portas + 2 painéis fixos | Vidro transparente | Fecho magnético | Haste fixação Angle cromado (2X) | Perfil cromado
 Shower frontal | 2 doors + 2 fixed panels | Transparent glass | Magnetic closure | Chrome Angle fixing rod (2x) | Chrome profile
 Frontal de douche | 2 portes + 2 panneaux fixes | Verre transparent | Fermeture magnétique | Barre de fixation Angle chromée (2x) | Profilé chromé
 Mampara ducha frontal | 2 puertas + 2 paneles laterales | Cristal transparente | Cierre magnético | Varilla de fijación Angle chromo (2x) | Perfil chromo



Frontal duche | 1 porta + 1 painel fixo | Vidro transparente | Fecho magnético central | Haste fixação Row e perfil preto mate
Shower frontal | 1 door + 1 fixed panel | Transparent glass | Central magnetic closure | Row fixing rod and matt black profile
Frontal de douche | 1 porte + 1 panneau fixe | Verre transparent | Fermeture magnétique centrale | Barre de fixation Row et profilé noir mat
Mampara ducha frontal | 1 puerta + 1 panel fijo | Cristal transparente | Cierre magnético central | Varilla de fijación Row y perfil negro mate

móveis

espelhos

torneiras

acessórios
de banho

divisórias

bases e
banheiras

sistemas de
instalação

coleções
sanitárias

espaços
públicos



Cabine duche | 1 porta + 1 painel lateral | Vidro serigrafia Ômega | Fecho magnético | Haste fixação Row branca e perfil branco mate
 Shower cabin | 1 door + 1 side panel | Glass with Ômega screen printing | Magnetic closure | White Row fixing rod and matt white profile
 Cabine de douche | 1 porte + 1 panneau latéral | Verre avec sérigraphie Ômega | Fermeture magnétique | Barre de fixation Row blanche et profilé blanc mat
 Mampara ducha | 1 puerta + 1 panel lateral | Cristal serigrafiado Ômega | Cierre magnético | Varilla de fijación Row blanco y perfil blanco mate



Frontal de duche | 1 porta | vidro serigrafado Beta | perfil cromado.
Shower front | 1 door | Beta screen-printed glass | Chrome profile
Frontal de douche | 1 porte | Verre sérigraphié Beta | Profilé chromé
Mampara ducha frontal | 1 puerta | vidrio serigrafiado Beta | perfil cromado.

móveis

espelhos

torneiras

acessórios
de banho

divisórias

bases e
banheiras

sistemas de
instalação

coleções
sanitárias

espaços
públicos

Cabine de duche 1 porta + 1 fixo + 1 lateral

Shower enclosure 1 door + 1 fixed panel + 1 side panel

Cabine de douche 1 porte + 1 panneau fixe + panneau latéral

Mampara de ducha 1 puerta + 1 fijo + 1 panel lateral

cm	Ajuste adjustment réglage ajuste	Porta door porte puerta	fixo Fixed Fixe Fijo	Abertura opening ouverture apertura	REF	€ *
70 x 70	98 101	40	30	55	30400 _ _ _ _	690,00 €
70 x 90	103 106	50	40	55	30401 _ _ _ _	740,00 €
70 x 100	108 111	60	40	55	30402 _ _ _ _	760,00 €
70 x 110	113 116	60	50	55	30403 _ _ _ _	790,00 €
70 x 120	118 121	70	50	65	30404 _ _ _ _	810,00 €
70 x 130	123 126	70	60	65	30405 _ _ _ _	840,00 €
70 x 140	128 131	80	60	65	30406 _ _ _ _	860,00 €
70 x 150	133 136	80	70	65	30407 _ _ _ _	890,00 €
70 x 160	138 141	80	80	75	30408 _ _ _ _	910,00 €
75 x 75	73,5 - 73,5	45	30	42	30409 _ _ _ _	710,00 €
75 x 90	73,5 - 88,5	50	40	47	30410 _ _ _ _	750,00 €
75 x 100	73,5 - 98,5	60	40	57	30411 _ _ _ _	770,00 €
75 x 110	73,5 - 108,5	60	50	57	30412 _ _ _ _	800,00 €
75 x 120	73,5 - 118,5	70	50	67	30413 _ _ _ _	820,00 €
75 x 130	73,5 - 128,5	70	60	67	30414 _ _ _ _	850,00 €
75 x 140	73,5 - 138,5	80	60	77	30415 _ _ _ _	870,00 €
75 x 150	73,5 - 148,5	80	70	77	30416 _ _ _ _	900,00 €
75 x 160	73,5 - 158,5	80	80	77	30417 _ _ _ _	930,00 €
80 x 80	78,5 - 78,5	50	30	47	30418 _ _ _ _	740,00 €
80 x 90	78,5 - 88,5	50	40	47	30419 _ _ _ _	760,00 €
80 x 100	78,5 - 98,5	60	40	57	30420 _ _ _ _	790,00 €
80 x 110	78,5 - 108,5	60	50	57	30421 _ _ _ _	810,00 €
80 x 120	78,5 - 118,5	70	50	67	30422 _ _ _ _	840,00 €
80 x 130	78,5 - 128,5	70	60	67	30423 _ _ _ _	860,00 €
80 x 140	78,5 - 138,5	80	60	77	30424 _ _ _ _	890,00 €
80 x 150	78,5 - 148,5	80	70	77	30425 _ _ _ _	910,00 €
80 x 160	78,5 - 158,5	80	80	77	30426 _ _ _ _	940,00 €
90 x 90	88,5 - 88,5	50	40	47	30427 _ _ _ _	780,00 €
90 x 100	88,5 - 98,5	60	40	57	30428 _ _ _ _	810,00 €
90 x 110	88,5 - 108,5	60	50	57	30429 _ _ _ _	830,00 €
90 x 120	88,5 - 118,5	70	50	67	30430 _ _ _ _	860,00 €
90 x 130	88,5 - 128,5	70	60	67	30431 _ _ _ _	890,00 €
90 x 140	88,5 - 138,5	80	60	77	30432 _ _ _ _	910,00 €
90 x 150	88,5 - 148,5	80	70	77	30433 _ _ _ _	940,00 €
90 x 160	88,5 - 158,5	80	80	77	30434 _ _ _ _	960,00 €

⚠ **Avisos · warning**
avertissements · avisos

Altura máxima · maximum height
Hauter maximale · Altura máxima 220cm

Largura máxima · Maximum width
Largeur maximale · Anchura máxima 160cm

Largura máxima porta · door maximum width
Largeur maximale porte · Anchura máxima puerta 80cm

Cabine de duche 2 portas + 1 fixo

Shower enclosure panel 2 doors + 1 fixed panel

Cabine de douche 2 portes + 1 panneau fixe

Mampara de ducha 2 puertas + 1 fijo

cm	Ajuste adjustment réglage ajuste	Porta door porte puerta	fixo Fixed Fixe Fijo	Abertura opening ouverture apertura	REF	€ *
70 x 70	68,5 - 68,5	40	30	72	30435 _ _ _ _	780,00 €
70 x 90	68,5 - 88,5	50	40	78	30436 _ _ _ _	830,00 €
70 x 100	68,5 - 98,5	60	40	84	30437 _ _ _ _	850,00 €
70 x 110	68,5 - 108,5	60	50	84	30438 _ _ _ _	880,00 €
70 x 120	68,5 - 118,5	70	50	91	30439 _ _ _ _	900,00 €
70 x 130	68,5 - 128,5	70	60	91	30440 _ _ _ _	930,00 €
70 x 140	68,5 - 138,5	80	60	99	30441 _ _ _ _	950,00 €
70 x 150	68,5 - 148,5	80	70	99	30442 _ _ _ _	980,00 €
70 x 160	68,5 - 158,5	80	80	99	30443 _ _ _ _	1 010,00 €
75 x 75	73,5 - 73,5	45	30	79	30444 _ _ _ _	800,00 €
75 x 90	73,5 - 88,5	50	40	82	30445 _ _ _ _	840,00 €
75 x 100	73,5 - 98,5	60	40	88	30446 _ _ _ _	870,00 €
75 x 110	73,5 - 108,5	60	50	88	30447 _ _ _ _	890,00 €
75 x 120	73,5 - 118,5	70	50	95	30448 _ _ _ _	920,00 €
75 x 130	73,5 - 128,5	70	60	95	30449 _ _ _ _	940,00 €
75 x 140	73,5 - 138,5	80	60	102	30450 _ _ _ _	970,00 €
75 x 150	73,5 - 148,5	80	70	102	30451 _ _ _ _	990,00 €
75 x 160	73,5 - 158,5	80	80	102	30452 _ _ _ _	1 020,00 €
80 x 80	78,5 - 78,5	50	30	86	30453 _ _ _ _	830,00 €
80 x 90	78,5 - 88,5	50	40	86	30454 _ _ _ _	850,00 €
80 x 100	78,5 - 98,5	60	40	92	30455 _ _ _ _	880,00 €
80 x 110	78,5 - 108,5	60	50	92	30456 _ _ _ _	900,00 €
80 x 120	78,5 - 118,5	70	50	98	30457 _ _ _ _	930,00 €
80 x 130	78,5 - 128,5	70	60	98	30458 _ _ _ _	950,00 €
80 x 140	78,5 - 138,5	80	60	105	30459 _ _ _ _	980,00 €
80 x 150	78,5 - 148,5	80	70	105	30460 _ _ _ _	1 000,00 €
80 x 160	78,5 - 158,5	80	80	105	30461 _ _ _ _	1 030,00 €
90 x 90	88,5 - 88,5	50	40	95	30462 _ _ _ _	880,00 €
90 x 100	88,5 - 98,5	60	40	100	30463 _ _ _ _	900,00 €
90 x 110	88,5 - 108,5	60	50	100	30464 _ _ _ _	930,00 €
90 x 120	88,5 - 118,5	70	50	106	30465 _ _ _ _	950,00 €
90 x 130	88,5 - 128,5	70	60	106	30466 _ _ _ _	980,00 €
90 x 140	88,5 - 138,5	80	60	113	30467 _ _ _ _	1 000,00 €
90 x 150	88,5 - 148,5	80	70	113	30468 _ _ _ _	1 030,00 €
90 x 160	88,5 - 158,5	80	80	113	30469 _ _ _ _	1 050,00 €

⚠ **Avisos · warning**
avertissements · avisos

Altura máxima · maximum height
Hauter maximale · Altura máxima 220cm

Largura máxima · Maximum width
Largeur maximale · Anchura máxima 160cm

Largura máxima porta · door maximum width
Largeur maximale porte · Anchura máxima puerta 100cm

Cabine de duche 1 porta + 1 lateral

Shower enclosure panel 1 door + 1 side panel
Cabine de douche 1 porte + 1 panneau latéral
Mampara de ducha 1 puerta + 1 panel lateral

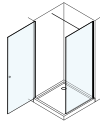

cm	Ajuste adjustment réglage ajuste	Abertura opening ouverture apertura	REF	€ *
70 x 70	68,5 68,5	62	30477 _ _ _ _	630,00 €
70 x 90	68,5 88,5	62	30478 _ _ _ _	680,00 €
75 x 75	73,5 73,5	67	30479 _ _ _ _	660,00 €
75 x 90	73,5 88,5	67	30480 _ _ _ _	690,00 €
80 x 80	78,5 78,5	72	30481 _ _ _ _	680,00 €
80 x 90	78,5 88,5	72	30482 _ _ _ _	700,00 €
90 x 70	88,5 78,5	82	30483 _ _ _ _	680,00 €
90 x 75	88,5 73,5	82	30484 _ _ _ _	690,00 €
90 x 80	88,5 78,5	82	30485 _ _ _ _	710,00 €
90 x 90	88,5 88,5	82	30486 _ _ _ _	730,00 €

Cabine de duche 2 portas

Shower enclosure panel 2 doors
Cabine de douche 2 portes
Mampara de ducha 2 puertas

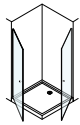

cm	Ajuste adjustment réglage ajuste	Abertura opening ouverture apertura	REF	€ *
70 x 70	68,5 - 68,5	88	30470 _ _ _ _	720,00 €
70 x 90	68,5 - 88,5	103	30471 _ _ _ _	770,00 €
75 x 75	73,5 - 73,5	95	30472 _ _ _ _	750,00 €
75 x 90	73,5 - 88,5	106	30473 _ _ _ _	790,00 €
80 x 80	78,5 - 78,5	102	30474 _ _ _ _	770,00 €
80 x 90	78,5 - 88,5	110	30475 _ _ _ _	800,00 €
90 x 90	88,5 - 88,5	116	30476 _ _ _ _	820,00 €

Cabine de duche 2 portas + 2 fixos

Shower enclosure panel 2 doors + 2 fixes panels
Cabine de douche 2 portes + 2 panneaux fixes
Mampara de ducha 2 puertas + 2 paneles fijos



H

cm	Ajuste adjustment réglage ajuste	Porta door porte puerta	fixo Fixed Fixe Fijo	Abertura opening ouverture apertura	REF	€ *
70 x 70	68,5 68,5	40	30	52	30500 _ _ _ _	830,00 €
70 x 90	68,5 88,5	40	30	59	30501 _ _ _ _	880,00 €
75 x 75	73,5 73,5	45	30	59	30502 _ _ _ _	860,00 €
75 x 90	73,5 88,5	45	30	63	30503 _ _ _ _	900,00 €
80 x 80	78,5 78,5	50	30	66	30504 _ _ _ _	880,00 €
80 x 90	78,5 88,5	50	30	66	30505 _ _ _ _	910,00 €
90 x 90	88,5 88,5	50	40	66	30506 _ _ _ _	930,00 €

Códigos · codes · codes · códigos :

acabamentos vidro glass finishes finishions verre acabados cristal	acabamentos metal metal finishes finishions métal acabados metal
Pág. 192	Pág. 190

⚠ **Avisos · warning**
avertissements · avisos

Altura máxima · maximum height Hauter maximale · Altura máxima	220cm
Largura máxima · Maximum width Largeur maximale · Anchura máxima	100cm
Largura máxima porta · door maximum width Largeur maximale porte · Anchura máxima puerta	100cm

⚠ **Avisos · warning**
avertissements · avisos

Altura máxima · maximum height Hauter maximale · Altura máxima	220cm
Largura máxima · Maximum width Largeur maximale · Anchura máxima	100cm
Largura máxima porta · door maximum width Largeur maximale porte · Anchura máxima puerta	100cm

⚠ **Avisos · warning**
avertissements · avisos

Altura máxima · maximum height Hauter maximale · Altura máxima	220cm
Largura máxima · Maximum width Largeur maximale · Anchura máxima	160cm
Largura máxima porta · door maximum width Largeur maximale porte · Anchura máxima puerta	80cm

móveis

espelhos

torneiras

acessórios
de banho

divisórias

bases e
banheiras

sistemas de
instalação

coleções
sanitárias

espaços
públicos

Frontal de duche 1 porta + 1 fixo · Shower front 1 door + 1 fixed panel
 Frontal de douche 1 porte + 1 panneau fixe · Frontal de ducha 1 puerta + 1 fijo

cm	Ajuste adjustment réglage ajuste	Porta door porte puerta	fixo Fixed Fixe Fijo	Abertura opening ouverture apertura	REF	€ *
100	98 101	60	40	55	30487 _ _ _ _	520,00 €
105	103 106	60	45	55	30488 _ _ _ _	535,00 €
110	108 111	60	50	55	30489 _ _ _ _	545,00 €
115	113 116	60	55	55	30490 _ _ _ _	560,00 €
120	118 121	70	50	65	30491 _ _ _ _	570,00 €
125	123 126	70	55	65	30492 _ _ _ _	585,00 €
130	128 131	70	60	65	30493 _ _ _ _	595,00 €
135	133 136	70	65	65	30494 _ _ _ _	605,00 €
140	138 141	80	60	75	30495 _ _ _ _	620,00 €
145	143 146	80	65	75	30496 _ _ _ _	630,00 €
150	148 151	80	70	75	30497 _ _ _ _	645,00 €
155	153 156	80	75	75	30498 _ _ _ _	655,00 €
160	158 161	80	80	75	30499 _ _ _ _	670,00 €

ⓘ **Avisos** · warning
avertissements · avisos

Altura máxima · maximum height
Hauter maximale · Altura máxima 220cm

Largura máxima · Maximum width
Largeur maximale · Anchura máxima 180cm

Largura máxima porta · door maximum width
Largeur maximale porte · Anchura máxima puerta 90cm

Frontal de duche 1 porta + 1 fixo · Shower front 1 door + 1 fixed panel
 Frontal de douche 1 porte + 1 panneau fixe · Frontal de ducha 1 puerta + 1 fijo

cm	Ajuste adjustment réglage ajuste	Porta door porte puerta	fixo Fixed Fixe Fijo	Abertura opening ouverture apertura	REF	€ *
100	98 101	60	40	51	30507 _ _ _ _	560,00 €
105	103 106	60	45	51	30508 _ _ _ _	575,00 €
110	108 111	60	50	51	30509 _ _ _ _	585,00 €
115	113 116	60	55	51	30510 _ _ _ _	600,00 €
120	118 121	70	50	61	30511 _ _ _ _	610,00 €
125	123 126	70	55	61	30512 _ _ _ _	625,00 €
130	128 131	70	60	61	30513 _ _ _ _	635,00 €
135	133 136	70	65	61	30514 _ _ _ _	650,00 €
140	138 141	80	60	71	30515 _ _ _ _	660,00 €
145	143 146	80	65	71	30516 _ _ _ _	675,00 €
150	148 151	80	70	71	30517 _ _ _ _	685,00 €
155	153 156	80	75	71	30518 _ _ _ _	700,00 €
160	158 161	80	80	71	30519 _ _ _ _	710,00 €

ⓘ **Avisos** · warning
avertissements · avisos

Altura máxima · maximum height
Hauter maximale · Altura máxima 220cm

Largura máxima · Maximum width
Largeur maximale · Anchura máxima 180cm

Largura máxima porta · door maximum width
Largeur maximale porte · Anchura máxima puerta 80cm

Frontal de duche 1 porta + 1 fixo · Shower front 1 door + 1 fixed panel
 Frontal de douche 1 porte + 1 panneau fixe · Frontal de ducha 1 puerta + 1 fijo

cm	Ajuste adjustment réglage ajuste	Abertura opening ouverture apertura	REF	€ *
70	68 71	58	30546 _ _ _ _	440,00 €
75	73 76	63	30547 _ _ _ _	450,00 €
80	78 81	68	30548 _ _ _ _	465,00 €
85	83 86	73	30549 _ _ _ _	475,00 €
90	88 91	78	30550 _ _ _ _	490,00 €
95	93 96	83	30551 _ _ _ _	500,00 €
100	98 101	88	30552 _ _ _ _	515,00 €



ⓘ **Avisos** · warning
avertissements · avisos

Altura máxima · maximum height
Hauter maximale · Altura máxima 220cm

Largura máxima · Maximum width
Largeur maximale · Anchura máxima 100cm

Largura máxima porta · door maximum width
Largeur maximale porte · Anchura máxima puerta 100cm

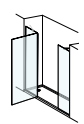
Frontal de duche 1 porta + 2 fixos · Shower front 1 door + 2 fixed panels
Frontal de douche 1 porte + panneaux fixes · Frontal de ducha 1 puerta + 2 paneles fijos

	cm	Ajuste adjustment réglage ajuste	Porta door porte puerta	fixo Fixed Fixe Fijo	Abertura opening ouverture apertura	REF	€ *
	140	138 141	75	32,5	70	30520 _ _ _ _	680,00 €
	145	143 146	75	35	70	30521 _ _ _ _	700,00 €
	150	148 151	75	37,5	70	30522 _ _ _ _	710,00 €
	155	153 156	75	40	70	30523 _ _ _ _	720,00 €
	160	158 161	75	42,5	70	30524 _ _ _ _	740,00 €
	165	163 166	75	45	70	30525 _ _ _ _	750,00 €
	170	168 171	75	47,5	70	30526 _ _ _ _	760,00 €
	175	173 176	80	50	75	30527 _ _ _ _	790,00 €
	180	178 181	80	50	75	30528 _ _ _ _	790,00 €
	185	183 186	80	52,5	75	30529 _ _ _ _	800,00 €
	190	188 191	80	55	75	30530 _ _ _ _	810,00 €
	195	193 196	80	57,5	75	30531 _ _ _ _	820,00 €
	200	198 201	80	60	75	30532 _ _ _ _	840,00 €

Códigos · codes · codes · códigos :

acabamentos vidro glass finishes finishions verre acabados cristal	acabamentos metal metal finishes finishions métal acabados metal
Pág. 192	Pág. 190

 **Avisos** · warning
avertissements · avisos

Altura máxima · maximum height
Hauter maximale · Altura máxima 220cm

Largura máxima · Maximum width
Largeur maximale · Anchura máxima 240cm

Largura máxima porta · door maximum width
Largeur maximale porte · Anchura máxima puerta 80cm

Frontal de duche 2 portas + 2 fixos · Shower front 2 doors + 2 fixed panels
Frontal de douche 2 portes + panneaux fixes · Frontal de ducha 2 puertas + 2 paneles fijos

	cm	Ajuste adjustment réglage ajuste	Porta door porte puerta	fixo Fixed Fixe Fijo	Abertura opening ouverture apertura	REF	€ *
	140	138 141	75	32,5	75	30533 _ _ _ _	810,00 €
	145	143 146	75	35	75	30534 _ _ _ _	820,00 €
	150	148 151	75	37,5	75	30535 _ _ _ _	830,00 €
	155	153 156	75	40	75	30536 _ _ _ _	840,00 €
	160	158 161	75	42,5	75	30537 _ _ _ _	860,00 €
	165	163 166	75	45	75	30538 _ _ _ _	870,00 €
	170	168 171	75	47,5	75	30539 _ _ _ _	880,00 €
	175	173 176	80	50	95	30540 _ _ _ _	890,00 €
	180	178 181	80	50	95	30541 _ _ _ _	910,00 €
	185	183 186	80	52,5	95	30542 _ _ _ _	920,00 €
	190	188 191	80	55	95	30543 _ _ _ _	930,00 €
	195	193 196	80	57,5	95	30544 _ _ _ _	940,00 €
	200	198 201	80	60	95	30545 _ _ _ _	960,00 €



 **Avisos** · warning
avertissements · avisos

Altura máxima · maximum height
Hauter maximale · Altura máxima 220cm

Largura máxima · Maximum width
Largeur maximale · Anchura máxima 240cm

Largura máxima porta · door maximum width
Largeur maximale porte · Anchura máxima puerta 80cm

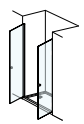
Frontal de duche 2 portas · Shower front 2 doors
Frontal de douche 2 portes · Frontal de ducha 2 puertas

	cm	Ajuste adjustment réglage ajuste	Abertura opening ouverture apertura	REF	€ *
	70	68 71	57	30553 _ _ _ _	520,00 €
	75	73 76	62	30554 _ _ _ _	530,00 €
	80	78 81	67	30555 _ _ _ _	550,00 €
	85	83 86	72	30556 _ _ _ _	560,00 €
	90	88 91	77	30557 _ _ _ _	570,00 €
	95	93 96	82	30558 _ _ _ _	580,00 €
	100	98 101	87	30559 _ _ _ _	600,00 €

 **Avisos** · warning
avertissements · avisos

Altura máxima · maximum height
Hauter maximale · Altura máxima 220cm

Largura máxima · Maximum width
Largeur maximale · Anchura máxima 200cm

Largura máxima porta · door maximum width
Largeur maximale porte · Anchura máxima puerta 100cm

Cores de perfil · profile colors
couleurs de profil · colores de perfil

20	Cromado · Chrome Chromé · Cromo	
20	Preto · Black Noir · Negro	+ 20 %
20	Cores · Colors Couleurs · Colores	+ 30 %
25	Metais · metals métaux · metales	+ 40 %

Opções de vidro · opciones de cristal
glass options · Options de verre

cm	serigrafado serigrafia screen printed sérigraphié	fosco mate frosted mat	gris/bronze gris/bronze gris/bronze gris/bronze	impressão digital digital printing impression numérique impresión digital	canelado fluted cannelé acanalado
≤ 100	+ 30 €	+ 100 €	+ 150 €	+ 250 €	+ 250 €
101 - 200	+ 60 €	+ 200 €	+ 300 €	+ 500 €	+ 500 €
201-300	+ 90 €	+ 300 €	+ 450 €	+ 750 €	+ 750 €
	20	25			

Variação de medidas · size variation
variation des mesures · variación de medidas

Cada 10cm (altura/largura) acrescentar

Add every 10 cm (height/width)

Ajouter tous les 10cm (hauteur/largeur)

Cada 10cm (altura/ancho) aumentar

30 €



Frontal de duche | 2 portas | Vidro transparente | Fecho magnético | Perfil branco mate

Mampara ducha frontal | 2 puertas | Cristal transparente | Cierre magnético | Perfil blanco mate

Shower front | 2 doors | Transparent glass | Magnetic lock | Matte white profile

Front de douche | 2 portes | Verre transparent | Fermeture magnétique | Profil blanc mat



Espessura do vidro
Glass thickness
Épaisseur du verre
Espesor del cristal



Vidros c/ outros acabamentos
Glass with other finishes
Verres avec d'autres finitions
Cristal con otros acabados



Limpeza fácil
Easy clean
Facile à nettoyer
Fácil limpieza



Reversível**
Réversible
Réversible
Reversible



2m altura
2m height
2m hauteur
2m altura



Haste de fixação incluída
Fixing rod included
Tige de fixation incluse
Varilla de fijación incluida

* Preço para perfil cromado e vidro transparente · Price for chromed profile and transparente glass · Prix pour profil chromé et verre transparent · Precio para perfil cromo y cristal transparente

** Reversível somente para vidro transparente · Reversible for transparent glass only · Réversible uniquement pour verre transparent · Reversible solo para vidrio transparente



Row

Haste de fixação 180° · Fixing rod
Tige de fixation · Varilla de fijación

cm	Ajuste · adjustment réglage · ajuste	REF	€*
100	Parede / vidro 180° · wall / glass paroi / verre · pared / vidrio	DB97100 __	55,00 €
100	Vidro / vidro 180° · glass / glass verre / verre · vidrio / vidrio	DB97101 __	56,20 €
100+100	Teto / vidro 180° · ceiling / glass plafond / verre · techo / vidrio	DB97102 __	62,30 €
100+100	"T" Parede / vidro / vidro 180° · wall / glass / glass paroi / verre / verre · pared / vidrio / vidrio	DB97103 __	102,80 €

Angle

Haste de fixação 180° · Fixing rod
Tige de fixation · Varilla de fijación

cm	Ajuste · adjustment réglage · ajuste	REF	€*
100	Parede / vidro 180° · wall / glass paroi / verre · pared / vidrio	DB97110 __	71,20 €
100	Vidro / vidro 180° · glass / glass verre / verre · vidrio / vidrio	DB97111 __	72,80 €
50	Parede / vidro 50cm 45° · wall / glass paroi / verre · pared / vidrio	DB97112 __	71,20 €
100+100	"T" Parede / vidro / vidro 180° · wall / glass / glass paroi / verre / verre · pared / vidrio / vidrio	DB97113 __	108,90 €

Cores · colors
couleurs · colores

- 20 Cromado** · Chrome
Chromé · Cromo
- 20 Preto** · Black
Noir · Negro + 20 %
- 20 Cores** · Colors
Couleurs · Colores + 30 %
- 25 Metais** · metals
métaux · metales + 40 %

* Preço para perfil cromado e vidro transparente · Price for chromed profile and transparente glass · Prix pour profil chromé et verre transparent · Precio para perfil cromo y cristal transparente



Painel de banheira | 1 painel fixo + 1 painel móvel | Vidro transparente | Haste fixação Row e Perfil cromado
Bathtub panel | 1 fixed panel + 1 movable panel | Transparent glass | Row fixing rod and chrome profile
Panneau de baignoire | 1 panneau fixe + 1 panneau mobile | Verre transparent | Barre de fixation Row et Profil chromé
Mampara de Bañera | 1 puerta + 1 panel abatible | Cristal transparente | Haste fijación Row y Perfil cromo

Painel de banheira 1 fixo - canto redondo · Bathtub panel 1 fixed - rounded corner
 Panneau de baignoire 1 fixe - coin arrondi · Panel de bañera 1 fijo - canto redondo

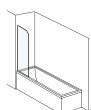

cm	REF	€ *
70	30567 _ _ _ _	240,00 €
75	30568 _ _ _ _	260,00 €
80	30569 _ _ _ _	280,00 €

Painel de banheira 1 fixo - canto reto · Bathtub panel 1 fixed - straight corner
 Panneau de baignoire 1 fixe - coin droit · Panel de bañera 1 fijo - canto recto

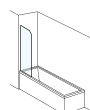

cm	REF	€ *
70	30570 _ _ _ _	240,00 €
75	30571 _ _ _ _	250,00 €
80	30572 _ _ _ _	270,00 €

Painel de banheira 2 portas · Bathtub panel 2 doors
 Panneau de baignoire 2 portes · Panel de bañera 2 puertas

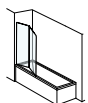

canto redondo
 rounded corner
 coin arrondi
 canto redondo

cm	REF	€ *
120	30573 _ _ _ _	480,00 €

canto reto
 straight corner
 coin droite
 canto recto

120	30574 _ _ _ _	480,00 €
-----	---------------	----------

Painel de banheira 1 porta + 1 fixo · Bathtub panel 1 door + 1 fixed panel
 Panneau de baignoire 1 porte + 1 panneau fixe · Panel de bañera 1 porta + 1 panel fijo

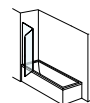

canto redondo
 rounded corner
 coin arrondi
 canto redondo

cm	REF	€ *
120	30578 _ _ _ _	430,00 €



canto reto
 straight corner
 coin droite
 canto recto

120	30579 _ _ _ _	430,00 €
-----	---------------	----------

Painel de banheira 1 porta · Bathtub panel 1 door
 Panneau de baignoire 1 porte · Panel de bañera 1 puerta

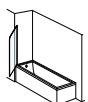

canto redondo
 rounded corner
 coin arrondi
 canto redondo

cm	REF	€ *
80	30580 _ _ _ _	300,00 €

canto reto
 straight corner
 coin droite
 canto recto

80	30581 _ _ _ _	300,00 €
----	---------------	----------

Opções de vidro · opciones de cristal
 glass options · Options de verre

cm	serigrafado serigrafia screen printed sérigraphié	fosco mate frosted mat	gris/bronze gris/bronze gris/bronze gris/bronze	impressão digital digital printing impression numérique impresión digital	canelado fluted canalé acanalado
≤ 100	+ 30 €	+ 70 €	+ 100 €	+ 170 €	+ 170 €
101 - 200	+ 60 €	+ 90 €	+ 120 €	+ 240 €	+ 240 €

20

25

Cores de perfil · profile colors
 couleurs de profil · colores de perfil

20	Cromado · Chrome Chromé · Cromo	
20	Preto · Black Noir · Negro	+ 20 %
20	Cores · Colors Couleurs · Colores	+ 30 %
25	Metais · metals métaux · metales	+ 40 %

Variação de medidas · size variation
 variation des mesures · variación de medidas

Cada 10cm (altura/largura) acrescentar
 Add every 10 cm (height/width)
 Ajouter tous les 10cm (hauteur/largeur)
 Cada 10cm (altura/ancho) aumentar

30 €



Espessura do vidro
 Glass thickness
 Épaisseur du verre
 Espesor del cristal



Vidros c/ outros acabamentos
 Glass with other finishes
 Verres avec d'autres finitions
 Cristal con otros acabados



Limpeza fácil
 Easy clean
 Facile à nettoyer
 Fácil limpieza



Reversível **
 Réversible
 Réversible
 Reversible



1,4m altura
 1,4m height
 1,4m hauteur
 1,4m altura



Haste de fixação incluída
 Fixing rod included
 Tige de fixation incluse
 Varilla de fijación incluida

* Preço para perfil cromado e vidro transparente · Price for chromed profile and transparente glass · Prix pour profil chromé et verre transparent · Precio para perfil cromo y cristal transparente

** Reversível somente para vidro transparente · Reversible for transparent glass only · Réversible uniquement pour verre transparent · Reversible solo para vidrio transparente

Bent



Frontal de duche 2 portas fole | Vidro transparente | Fecho magnético | Perfil ouro escovado
Shower front with 2 folding doors | Transparent glass | Magnetic closure | Brushed gold profile
Paroi frontale de douche 2 portes pliantes | Verre transparent | Fermeture magnétique | Profil or brossé
Mampara frontal de ducha de 2 puertas plegables | Cristal transparente | Cierre magnético | Perfil oro cepillado



Frontal de duche 1 porta fole | Vidro transparente | Fecho magnético | Perfil preto mate
Shower front with 1 folding door | Transparent glass | Magnetic closure | Matt black profile
Paroi frontale de douche 1 porte pliante | Verre transparent | Fermeture magnétique | Profil noir mat
Mampara frontal de ducha de 1 puerta plegable | Cristal transparente | Cierre magnético | Perfil negro mate

móveis

espelhos

torneiras

acessórios
de banho

divisórias

bases e
banheiras

sistemas de
instalação

coleções
sanitárias

espaços
públicos

Frontal de duche 2 portas fole

Front shower screen with 2 folding doors
Frontal de douche 2 portes pliantes
Frontal de ducha 2 puertas plegable



cm	Ajuste · adjustment réglage · ajuste	REF	€*	REF	€*	REF	€*
130	126 131	30211 __ 00	710,00 €	30211 __ 05	820,00 €	30211 __ 03	875,00 €
140	136 141	30212 __ 00	720,00 €	30212 __ 05	830,00 €	30212 __ 03	885,00 €
150	146 161	30213 __ 00	740,00 €	30213 __ 05	850,00 €	30213 __ 03	905,00 €
160	156 161	30214 __ 00	750,00 €	30214 __ 05	860,00 €	30214 __ 03	915,00 €
170	166 171	30215 __ 00	770,00 €	30215 __ 05	880,00 €	30215 __ 03	935,00 €
180	176 181	30216 __ 00	780,00 €	30216 __ 05	890,00 €	30216 __ 03	945,00 €
190	186 191	30217 __ 00	795,00 €	30217 __ 05	905,00 €	30217 __ 03	960,00 €
200	196 201	30218 __ 00	810,00 €	30218 __ 05	920,00 €	30218 __ 03	975,00 €

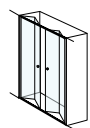

Códigos · codes · codes · códigos :

acabamentos vidro
glass finishes
finitions verre
acabados cristal

acabamentos metal
metal finishes
finitions métal
acabados metal

Pág. 192

Pág. 190

Frontal de duche 1 porta fole

Front shower screen with 1 folding door
Frontal de douche 1 porte pliante
Frontal de ducha 1 puerta plegable



cm	Ajuste · adjustment réglage · ajuste	REF	€*	REF	€*	REF	€*
70	70 75	30200 __ 00	415,00 €	30200 __ 05	495,00 €	30200 __ 03	535,00 €
75	75 80	30201 __ 00	420,00 €	30201 __ 05	500,00 €	30201 __ 03	540,00 €
80	80 85	30202 __ 00	430,00 €	30202 __ 05	510,00 €	30202 __ 03	550,00 €
85	85 90	30203 __ 00	435,00 €	30203 __ 05	515,00 €	30203 __ 03	555,00 €
90	90 95	30204 __ 00	445,00 €	30204 __ 05	525,00 €	30204 __ 03	565,00 €
95	95 100	30205 __ 00	450,00 €	30205 __ 05	530,00 €	30205 __ 03	570,00 €
100	100 105	30206 __ 00	455,00 €	30206 __ 05	565,00 €	30206 __ 03	620,00 €
105	105 110	30207 __ 00	465,00 €	30207 __ 05	575,00 €	30207 __ 03	630,00 €
110	110 115	30208 __ 00	470,00 €	30208 __ 05	580,00 €	30208 __ 03	635,00 €
115	115 120	30209 __ 00	480,00 €	30209 __ 05	590,00 €	30209 __ 03	645,00 €
120	120 125	30210 __ 00	485,00 €	30210 __ 05	595,00 €	30210 __ 03	650,00 €

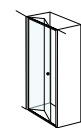

⚠ **Avisos · warning**
avertissements · avisos

Altura máxima · maximum height 220cm
Hauter maximale · Altura máxima

Largura máxima · Maximum width 200cm
Largueur maximale · Anchura máxima

Cores de perfil · profile colors
couleurs de profil · colores de perfil

Cromado · Chrome
Chromé · Cromo

Preto · Black
Noir · Negro

Ouro escovado · brushed gold
or brossé · oro cepillado

Painel lateral · Side panel

Panneau latéral · Panel lateral



Opções de vidro · opciones de cristal
glass options · Options de verre

cm	Ajuste adjustment réglage ajuste	REF	€*	REF	€*	REF	€*
70	67,5 70	31180 __ 00	150,00 €	31180 __ 05	260,00 €	31180 __ 03	315,00 €
75	72,5 75	31181 __ 00	155,00 €	31181 __ 05	265,00 €	31181 __ 03	320,00 €
80	77,5 80	31182 __ 00	160,00 €	31182 __ 05	270,00 €	31182 __ 03	325,00 €
90	87,5 90	31183 __ 00	170,00 €	31183 __ 05	280,00 €	31183 __ 03	335,00 €

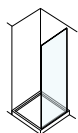

cm	serigrafado serigrafia screen printed sérigraphié	fosco mate frosted mat	gris/bronze gris/bronze gris/bronze	impressão digital digital printing impression numérique impresión digital
≤ 100	+ 30 €	+ 100 €	+ 150 €	+ 250 €
101 - 200	+ 60 €	+ 200 €	+ 300 €	+ 500 €
201-300	+ 90 €	+ 300 €	+ 450 €	+ 750 €



Espessura do vidro
Glass thickness
Épaisseur du verre
Espesor del cristal



Vidros c/ outros acabamentos
Glass with other finishes
Verres avec d'autres finitions
Cristal con otros acabados



Limpeza fácil
Easy clean
Facile à nettoyer
Fácil limpieza



Reversível **
Réversible
Réversible
Reversible



1,95m altura
1,95m height
1,95m hauteur
1,95m altura

* Preço para vidro transparente · Price for transparente glass · Prix pour verre transparent · Precio para cristal transparente

** Reversível somente para vidro transparente · Reversible for transparent glass only · Réversible uniquement pour verre transparent · Reversible solo para vidrio transparente



Cabine de duche 1 portas fole + painel lateral | Vidro transparente | Fecho magnético | Perfil metalizado
Enclosure with 1 folding door + side panel | Transparent glass | Magnetic closure | Metallic profile
Cabine de douche 1 porte pliante + panneau latéral | Verre transparent | Fermeture magnétique | Profil métallisé
Mampara de ducha de 1 puerta plegable + panel lateral | Cristal transparente | Cierre magnético | Perfil metalizado Shower

móveis

espelhos

torneiras

acessórios
de banho

divisórias

bases e
banheiras

sistemas de
instalação

coleções
sanitárias

espaços
públicos

Malu



Frontal duche | 1 porta + 1 painel fixo | Vidro transparente | Fecho magnético | Perfil cromado
Shower front | 1 door + 1 fixed panel | Transparent glass | Magnetic closure | Chrome profile
Paroi de douche | 1 porte + 1 panneau fixe | Verre transparent | Fermeture magnétique | Profilé chromé
Mampara ducha frontal | 1 puerta + 1 panel fijo | Cristal transparente | Cierre magnético | Perfil cromo



Frontal duche | 1 porta + 1 painel fixo | Vidro transparente | Fecho magnético | Perfil Preto mate
Shower front | 1 door + 1 fixed panel | Transparent glass | Magnetic closure | Matte black profile
Paroi de douche | 1 porte + 1 panneau fixe | Verre transparent | Fermeture magnétique | Profilé noir mat
Mampara ducha frontal | 1 puerta + 1 panel fijo | Cristal transparente | Cierre magnético | Perfil negro mate

móveis

espelhos

torneiras

acessórios
de banho

divisórias

bases e
banheiras

sistemas de
instalação

coleções
sanitárias

espaços
públicos



Cabine de douche | 2 portas + 2 painéis fixos | Vidro transparente | Fecho magnético | Perfil cromado
 Shower enclosure | 2 doors + 2 fixed panels | Transparent glass | Magnetic closure | Chrome profile
 Cabine de douche | 2 portes + 2 panneaux fixes | Verre transparent | Fermeture magnétique | Profilé chromé
 Mampara de ducha | 2 puertas + 2 paneles fijos | Cristal transparente | Cierre magnético | Perfil cromo



Frontal duche | 2 portas + 2 painéis fixos | Vidro transparente | Fecho magnético | Perfil cromado
Shower front | 2 doors + 2 fixed panels | Transparent glass | Magnetic closure | Chrome profile
Paroi de douche | 2 portes + 2 panneaux fixes | Verre transparent | Fermeture magnétique | Profilé chromé
Mampara ducha frontal | 2 puertas + 2 paneles fijos | Cristal transparente | Cierre magnético | Perfil chromo

Frontal de ducha 1 porta + 1 fixo · Front shower screen 1 door + 1 fixed panel
 Frontal de douche 1 porte + 1 panneau fixe · Frontal de ducha 1 puerta + 1 panel fijo

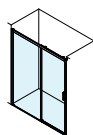

cm	Ajuste · adjustment réglage · ajuste	Abertura · opening ouverture · apertura (+ / - 1 cm)	REF	€ *	REF	€ *	REF	€ *
90	89 94	36	30940 __ 00	310,00 €	30940 __ 05	390,00 €	30940 __ 03	430,00 €
95	94 99	39	30941 __ 00	320,00 €	30941 __ 05	400,00 €	30941 __ 03	440,00 €
100	99 104	42	30942 __ 00	320,00 €	30942 __ 05	400,00 €	30942 __ 03	440,00 €
105	104 109	44	30943 __ 00	325,00 €	30943 __ 05	435,00 €	30943 __ 03	490,00 €
110	109 114	46	30944 __ 00	335,00 €	30944 __ 05	445,00 €	30944 __ 03	500,00 €
115	114 119	49	30945 __ 00	340,00 €	30945 __ 05	450,00 €	30945 __ 03	505,00 €
120	119 124	51	30946 __ 00	350,00 €	30946 __ 05	460,00 €	30946 __ 03	515,00 €
125	124 129	51	30947 __ 00	355,00 €	30947 __ 05	465,00 €	30947 __ 03	520,00 €
130	129 134	54	30948 __ 00	360,00 €	30948 __ 05	470,00 €	30948 __ 03	525,00 €
135	134 139	56	30949 __ 00	365,00 €	30949 __ 05	475,00 €	30949 __ 03	530,00 €
140	139 144	59	30950 __ 00	370,00 €	30950 __ 05	480,00 €	30950 __ 03	535,00 €
145	144 149	59	30951 __ 00	380,00 €	30951 __ 05	490,00 €	30951 __ 03	545,00 €
150	149 154	61	30952 __ 00	385,00 €	30952 __ 05	495,00 €	30952 __ 03	550,00 €
155	154 159	64	30953 __ 00	390,00 €	30953 __ 05	500,00 €	30953 __ 03	555,00 €
160	159 164	66	30954 __ 00	395,00 €	30954 __ 05	505,00 €	30954 __ 03	560,00 €
165	164 169	66	30955 __ 00	400,00 €	30955 __ 05	510,00 €	30955 __ 03	565,00 €
170	169 174	69	30956 __ 00	405,00 €	30956 __ 05	515,00 €	30956 __ 03	570,00 €
175	174 179	71	30957 __ 00	415,00 €	30957 __ 05	525,00 €	30957 __ 03	580,00 €
180	179 184	74	30958 __ 00	420,00 €	30958 __ 05	530,00 €	30958 __ 03	585,00 €

Frontal de ducha 2 portas + 2 fixos · Front shower screen 2 doors + 2 fixed panels
 Frontal de douche 2 portes + 2 panneaux fixes · Frontal de ducha 2 puertas + 2 paneles fijos

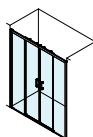

cm	Ajuste · adjustment réglage · ajuste	Abertura · opening ouverture · apertura (+ / - 1 cm)	REF	€ *	REF	€ *	REF	€ *
140	139 144	58	30960 __ 00	510,00 €	30960 __ 05	620,00 €	30960 __ 03	675,00 €
145	144 149	58	30961 __ 00	525,00 €	30961 __ 05	635,00 €	30961 __ 03	690,00 €
150	149 154	63	30962 __ 00	525,00 €	30962 __ 05	635,00 €	30962 __ 03	690,00 €
155	154 159	63	30963 __ 00	540,00 €	30963 __ 05	650,00 €	30963 __ 03	705,00 €
160	159 164	68	30964 __ 00	540,00 €	30964 __ 05	650,00 €	30964 __ 03	705,00 €
165	164 169	68	30965 __ 00	555,00 €	30965 __ 05	665,00 €	30965 __ 03	720,00 €
170	169 174	73	30966 __ 00	555,00 €	30966 __ 05	665,00 €	30966 __ 03	720,00 €
175	174 179	73	30967 __ 00	565,00 €	30967 __ 05	675,00 €	30967 __ 03	730,00 €
180	179 184	78	30968 __ 00	565,00 €	30968 __ 05	675,00 €	30968 __ 03	730,00 €
185	184 189	78	30969 __ 00	570,00 €	30969 __ 05	680,00 €	30969 __ 03	735,00 €
190	189 194	83	30970 __ 00	570,00 €	30970 __ 05	680,00 €	30970 __ 03	735,00 €
195	194 199	83	30971 __ 00	585,00 €	30971 __ 05	695,00 €	30971 __ 03	750,00 €
200	199 204	88	30972 __ 00	585,00 €	30972 __ 05	695,00 €	30972 __ 03	750,00 €

Painel lateral · Side panel
 Panneau latéral · Panel lateral



cm	Ajuste adjustment réglage ajuste	REF	€ *	REF	€ *	REF	€ *
70	67,5 70	30980 __ 00	185,00 €	30980 __ 05	265,00 €	30980 __ 03	305,00 €
75	72,5 75	30981 __ 00	190,00 €	30981 __ 05	270,00 €	30981 __ 03	310,00 €
80	77,5 80	30982 __ 00	200,00 €	30982 __ 05	280,00 €	30982 __ 03	320,00 €
90	87,5 90	30983 __ 00	210,00 €	30983 __ 05	290,00 €	30983 __ 03	330,00 €

Avisos · warning
 avertissements · avisos

Altura máxima · maximum height
 Hauteur maximale · Altura máxima 220cm

Largura máxima · Maximum width
 Largeur maximale · Anchura máxima 200cm

Largura máxima porta · door maximum width
 Largeur maximale porte · Anchura máxima puerta 83cm



cm	Ajuste · adjustment réglage · ajuste	Abertura · opening ouverture · apertura (+ / - 1 cm)	REF	€ *	REF	€ *	REF	€ *
70 x 70	67,5 70 - 67,5 70	36	30900 __ 00	405,00 €	30900 __ 05	515,00 €	30900 __ 03	570,00 €
70 x 90	67,5 70 - 87,5 90	43	30901 __ 00	430,00 €	30901 __ 05	540,00 €	30901 __ 03	595,00 €
70 x 100	67,5 70 - 97,5 100	48	30902 __ 00	440,00 €	30902 __ 05	550,00 €	30902 __ 03	605,00 €
70 x 110	67,5 70 - 107,5 110	52	30903 __ 00	450,00 €	30903 __ 05	560,00 €	30903 __ 03	615,00 €
70 x 120	67,5 70 - 117,5 120	56	30904 __ 00	465,00 €	30904 __ 05	575,00 €	30904 __ 03	630,00 €
70 x 130	67,5 70 - 127,5 130	58	30905 __ 00	480,00 €	30905 __ 05	590,00 €	30905 __ 03	645,00 €
70 x 140	67,5 70 - 137,5 140	63	30906 __ 00	490,00 €	30906 __ 05	630,00 €	30906 __ 03	700,00 €
70 x 150	67,5 70 - 147,5 150	65	30907 __ 00	500,00 €	30907 __ 05	640,00 €	30907 __ 03	710,00 €
70 x 160	67,5 70 - 157,5 160	70	30908 __ 00	510,00 €	30908 __ 05	650,00 €	30908 __ 03	720,00 €
75 x 75	72,5 75 - 72,5 75	39	30909 __ 00	415,00 €	30909 __ 05	525,00 €	30909 __ 03	580,00 €
75 x 90	72,5 75 - 87,5 90	45	30910 __ 00	435,00 €	30910 __ 05	545,00 €	30910 __ 03	600,00 €
75 x 100	72,5 75 - 97,5 100	49	30911 __ 00	445,00 €	30911 __ 05	555,00 €	30911 __ 03	610,00 €
75 x 110	72,5 75 - 107,5 110	53	30912 __ 00	455,00 €	30912 __ 05	565,00 €	30912 __ 03	620,00 €
75 x 120	72,5 75 - 117,5 120	58	30913 __ 00	470,00 €	30913 __ 05	580,00 €	30913 __ 03	635,00 €
75 x 130	72,5 75 - 127,5 130	60	30914 __ 00	485,00 €	30914 __ 05	625,00 €	30914 __ 03	695,00 €
75 x 140	72,5 75 - 137,5 140	64	30915 __ 00	495,00 €	30915 __ 05	635,00 €	30915 __ 03	705,00 €
75 x 150	72,5 75 - 147,5 150	66	30916 __ 00	510,00 €	30916 __ 05	650,00 €	30916 __ 03	720,00 €
75 x 160	72,5 75 - 157,5 160	71	30917 __ 00	520,00 €	30917 __ 05	660,00 €	30917 __ 03	730,00 €
80 x 80	77,5 80 - 77,5 80	43	30918 __ 00	430,00 €	30918 __ 05	540,00 €	30918 __ 03	595,00 €
80 x 90	77,5 80 - 87,5 90	47	30919 __ 00	440,00 €	30919 __ 05	550,00 €	30919 __ 03	605,00 €
80 x 100	77,5 80 - 97,5 100	50	30920 __ 00	450,00 €	30920 __ 05	560,00 €	30920 __ 03	615,00 €
80 x 110	77,5 80 - 107,5 110	54	30921 __ 00	465,00 €	30921 __ 05	575,00 €	30921 __ 03	630,00 €
80 x 120	77,5 80 - 117,5 120	59	30922 __ 00	480,00 €	30922 __ 05	590,00 €	30922 __ 03	645,00 €
80 x 130	77,5 80 - 127,5 130	61	30923 __ 00	490,00 €	30923 __ 05	630,00 €	30923 __ 03	700,00 €
80 x 140	77,5 80 - 137,5 140	65	30924 __ 00	500,00 €	30924 __ 05	640,00 €	30924 __ 03	710,00 €
80 x 150	77,5 80 - 147,5 150	67	30925 __ 00	515,00 €	30925 __ 05	655,00 €	30925 __ 03	725,00 €
80 x 160	77,5 80 - 157,5 160	72	30926 __ 00	525,00 €	30926 __ 05	665,00 €	30926 __ 03	735,00 €
90 x 90	87,5 90 - 87,5 90	50	30927 __ 00	455,00 €	30927 __ 05	565,00 €	30927 __ 03	620,00 €
90 x 100	87,5 90 - 97,5 100	54	30928 __ 00	465,00 €	30928 __ 05	575,00 €	30928 __ 03	630,00 €
90 x 110	87,5 90 - 107,5 110	57	30929 __ 00	475,00 €	30929 __ 05	585,00 €	30929 __ 03	640,00 €
90 x 120	87,5 90 - 117,5 120	62	30930 __ 00	490,00 €	30930 __ 05	630,00 €	30930 __ 03	700,00 €
90 x 130	87,5 90 - 127,5 130	63	30931 __ 00	505,00 €	30931 __ 05	645,00 €	30931 __ 03	715,00 €
90 x 140	87,5 90 - 137,5 140	68	30932 __ 00	515,00 €	30932 __ 05	655,00 €	30932 __ 03	725,00 €
90 x 150	87,5 90 - 147,5 150	70	30933 __ 00	530,00 €	30933 __ 05	670,00 €	30933 __ 03	740,00 €
90 x 160	87,5 90 - 157,5 160	74	30934 __ 00	540,00 €	30934 __ 05	680,00 €	30934 __ 03	750,00 €

Opções de vidro · opciones de cristal
glass options · Options de verre

cm	serigrafado serigrafia screen printed sérigraphié	fosco mate frosted mat	gris/bronce gris/bronce gris/bronce gris/bronce	impressão digital digital printing impression numérique impresión digital
≤ 100	+ 30 €	+ 100 €	+ 150 €	+ 250 €
101 - 200	+ 60 €	+ 200 €	+ 300 €	+ 500 €
201-300	+ 90 €	+ 300 €	+ 450 €	+ 750 €

10

25

Avisos · warning
avertissements · avisos

Altura máxima · maximum height Hauter maximale · Altura máxima	220cm
Largura máxima · Maximum width Largeur maximale · Anchura máxima	180cm
Largura máxima porta · door maximum width Largeur maximale porte · Anchura máxima puerta	83cm

Cores de perfil · profile colors
couleurs de profil · colores de perfil

- STOCK **Cromado · Chrome**
Chromé · Cromo
- 10 **Preto · Black**
Noir · Negro
- 25 **Ouro escovado · brushed gold**
or brossé · oro cepillado



Espessura do vidro
Glass thickness
Épaisseur du verre
Espesor del cristal



Vidros c/ outros acabamentos
Glass with other finishes
Verres avec d'autres finitions
Cristal con otros acabados



Limpeza fácil
Easy clean
Facile à nettoyer
Fácil limpieza



Reversível **
Réversible
Réversible
Reversible



2m altura
2m height
2m hauteur
2m altura

* Preço para vidro transparente · Price for transparente glass · Prix pour verre transparent · Precio para cristal transparente

** Reversível somente para vidro transparente · Reversible for transparent glass only · Réversible uniquement pour verre transparent · Reversible solo para vidrio transparente

Vela



Frontal duche | 2 portas + 2 painéis fixos + 1 painel fixo lateral | Vidro transparente | Fecho magnético | Perfil preto mate
Shower front | 2 doors + 2 fixed panels + 1 fixed side panel | Transparent glass | Magnetic closure | Matte black profile
Paroi de douche | 2 portes + 2 panneaux fixes + 1 panneau latéral fixe | Verre transparent | Fermeture magnétique | Profil noir mat
Mampara ducha frontal | 2 puertas + 2 paneles fijos + 1 panel fijo lateral | Cristal transparente | Cierre magnético | Perfil negro mate



Frontal duche | 1 porta + 1 painel fixo | Vidro transparente | Fecho magnético | Perfil cromado
Shower front | 1 door + 1 fixed panel | Transparent glass | Magnetic closure | Chrome profile
Paroi de douche | 1 porte + 1 panneau fixe | Verre transparent | Fermeture magnétique | Profil chromé
Mampara ducha frontal | 1 puerta + 1 panel fijo | Cristal transparente | Cierre magnético | Perfil cromo



Frontal duche | 1 porta + 1 painel fixo + 1 painel fixo lateral | Vidro transparente | Fecho magnético | Perfil cromado
 Shower front | 1 door + 1 fixed panel + 1 fixed side panel | Transparent glass | Magnetic closure | Chrome profile
 Paroi de douche | 1 porte + 1 panneau fixe + 1 panneau fixe latéral | Verre transparent | Fermeture magnétique | Profil chromé
 Mampara ducha frontal | 1 puerta + 1 panel fijo + 1 panel fijo lateral | Cristal transparente | Cierre magnético | Perfil cromo



Cabine duche | 2 portas + 2 painéis fixos | Vidro transparente | Fecho magnético | Perfil cromado
Shower enclosure | 2 doors + 2 fixed panels | Transparent glass | Magnetic closure | Chrome profile
Cabine de douche | 2 portes + 2 panneaux fixes | Verre transparent | Fermeture magnétique | Profil chromé
Mampara ducha | 2 puertas + 2 paneles fijos | Cristal transparente | Cierre magnético | Perfil cromo

móveis

espelhos

torneiras

acessórios
de banho

divisórias

bases e
banheiras

sistemas de
instalação

coleções
sanitárias

espaços
públicos

Frontal de ducha 1 porta + 1 fixo · Front shower screen 1 door + 1 fixed panel
 Frontal de ducha 1 porte + 1 panneau fixe · Frontal de ducha 1 puerta + 1 panel fijo

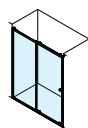

cm	Ajuste · adjustment réglage · ajuste	Abertura · opening ouverture · apertura (+ / - 1 cm)	REF	€ *	REF	€ *
90	85 90	32	30940 __ 00	250,00 €	31140 __ 05	360,00 €
95	90 95	35	30941 __ 00	255,00 €	31141 __ 05	365,00 €
100	95 100	37	30942 __ 00	260,00 €	31142 __ 05	370,00 €
105	100 105	40	30943 __ 00	270,00 €	31143 __ 05	380,00 €
110	105 110	42	30944 __ 00	270,00 €	31144 __ 05	380,00 €
115	110 115	45	30945 __ 00	275,00 €	31145 __ 05	385,00 €
120	115 120	47	30946 __ 00	280,00 €	31146 __ 05	390,00 €
125	120 125	50	30947 __ 00	285,00 €	31147 __ 05	395,00 €
130	125 130	52	30948 __ 00	290,00 €	31148 __ 05	400,00 €
135	130 135	55	30949 __ 00	295,00 €	31149 __ 05	405,00 €
140	135 140	57	30950 __ 00	300,00 €	31150 __ 05	410,00 €
145	140 145	60	30951 __ 00	305,00 €	31151 __ 05	415,00 €
150	145 150	62	30952 __ 00	310,00 €	31152 __ 05	420,00 €
155	150 155	65	30953 __ 00	310,00 €	31153 __ 05	420,00 €
160	155 160	67	30954 __ 00	315,00 €	31154 __ 05	425,00 €
165	160 165	70	30955 __ 00	320,00 €	31155 __ 05	430,00 €
170	165 170	72	30956 __ 00	330,00 €	31156 __ 05	440,00 €
175	170 175	75	30957 __ 00	340,00 €	31157 __ 05	450,00 €
180	175 180	77	30958 __ 00	330,00 €	31158 __ 05	440,00 €

Frontal de ducha 2 portas + 2 fixos · Front shower screen 2 doors + 2 fixed panels
 Frontal de ducha 2 portes + 2 panneaux fixes · Frontal de ducha 2 puertas + 2 paneles fijos

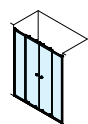

cm	Ajuste · adjustment réglage · ajuste	Abertura · opening ouverture · apertura (+ / - 1 cm)	REF	€ *	REF	€ *
140	135 140	49	30940 __ 00	250,00 €	31140 __ 05	360,00 €
145	140 145	54	30941 __ 00	255,00 €	31141 __ 05	365,00 €
150	145 150	54	30942 __ 00	260,00 €	31142 __ 05	370,00 €
155	150 155	59	30943 __ 00	270,00 €	31143 __ 05	380,00 €
160	155 160	59	30944 __ 00	270,00 €	31144 __ 05	380,00 €
165	160 165	64	30945 __ 00	275,00 €	31145 __ 05	385,00 €
170	165 170	64	30946 __ 00	280,00 €	31146 __ 05	390,00 €
175	170 175	69	30947 __ 00	285,00 €	31147 __ 05	395,00 €
180	175 180	69	30948 __ 00	290,00 €	31148 __ 05	400,00 €
185	180 185	74	30949 __ 00	295,00 €	31149 __ 05	405,00 €
190	185 190	74	30950 __ 00	300,00 €	31150 __ 05	410,00 €
195	190 195	79	30951 __ 00	305,00 €	31151 __ 05	415,00 €
200	195 200	79	30952 __ 00	310,00 €	31152 __ 05	420,00 €

Painel lateral · Side panel
 Panneau latéral · Panel lateral

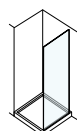

cm	Ajuste adjustment réglage ajuste	REF	€ *	REF	€ *
70	67,5 70	31180 __ 00	150,00 €	31180 __ 05	260,00 €
75	72,5 75	31181 __ 00	155,00 €	31181 __ 05	265,00 €
80	77,5 80	31182 __ 00	160,00 €	31182 __ 05	270,00 €
90	87,5 90	31183 __ 00	170,00 €	31183 __ 05	280,00 €

⚠ **Avisos** · warning
avertissements · avisos

Altura máxima · maximum height
Hauter maximale · Altura máxima 220cm

Largura máxima · Maximum width
Largeur maximale · Anchura máxima 200cm

Largura máxima porta · door maximum width
Largeur maximale porte · Anchura máxima puerta 88cm

Cabine de duche 2 portas + 2 fixos

Shower enclosure 2 doors + 2 fixed panels
Cabine de douche 2 portes + 2 panneaux fixes
Mampara de ducha 2 puertas + 2 paneles fijos

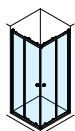

cm	Ajuste adjustment réglage ajuste	Abertura opening ouverture apertura (+ / - 1 cm)	REF	€ *	REF	€ *
70 x 70	68,5 70 - 68,5 70	35	31100 __ 00	250,00 €	31100 __ 05	360,00 €
70 x 90	68,5 70 - 88,5 90	42	31101 __ 00	255,00 €	31101 __ 05	365,00 €
70 x 100	68,5 70 - 98,5 100	46	31102 __ 00	260,00 €	31102 __ 05	370,00 €
70 x 110	68,5 70 - 108,5 110	51	31103 __ 00	270,00 €	31103 __ 05	380,00 €
70 x 120	68,5 70 - 118,5 120	55	31104 __ 00	270,00 €	31104 __ 05	380,00 €
70 x 130	68,5 70 - 128,5 130	55	31105 __ 00	275,00 €	31105 __ 05	385,00 €
70 x 140	68,5 70 - 138,5 140	55	31106 __ 00	280,00 €	31106 __ 05	390,00 €
70 x 150	68,5 70 - 148,5 150	55	31107 __ 00	285,00 €	31107 __ 05	395,00 €
70 x 160	68,5 70 - 158,5 160	55	31108 __ 00	290,00 €	31108 __ 05	400,00 €
75 x 75	73,5 75 - 73,5 75	38	31109 __ 00	320,00 €	31109 __ 05	430,00 €
75 x 90	73,5 75 - 88,5 90	44	31110 __ 00	335,00 €	31110 __ 05	445,00 €
75 x 100	73,5 75 - 98,5 100	48	31111 __ 00	345,00 €	31111 __ 05	455,00 €
75 x 110	73,5 75 - 108,5 110	52	31112 __ 00	350,00 €	31112 __ 05	460,00 €
75 x 120	73,5 75 - 118,5 120	56	31113 __ 00	365,00 €	31113 __ 05	475,00 €
75 x 130	73,5 75 - 128,5 130	56	31114 __ 00	375,00 €	31114 __ 05	485,00 €
75 x 140	73,5 75 - 138,5 140	56	31115 __ 00	385,00 €	31115 __ 05	495,00 €
75 x 150	73,5 75 - 148,5 150	56	31116 __ 00	390,00 €	31116 __ 05	500,00 €
75 x 160	73,5 75 - 158,5 160	56	31117 __ 00	400,00 €	31117 __ 05	510,00 €
80 x 80	78,5 80 - 78,5 80	42	31118 __ 00	330,00 €	31118 __ 05	440,00 €
80 x 90	78,5 80 - 88,5 90	45	31119 __ 00	340,00 €	31119 __ 05	450,00 €
80 x 100	78,5 80 - 98,5 100	49	31120 __ 00	350,00 €	31120 __ 05	460,00 €
80 x 110	78,5 80 - 108,5 110	53	31121 __ 00	355,00 €	31121 __ 05	465,00 €
80 x 120	78,5 80 - 118,5 120	58	31122 __ 00	370,00 €	31122 __ 05	480,00 €
80 x 130	78,5 80 - 128,5 130	58	31123 __ 00	380,00 €	31123 __ 05	490,00 €
80 x 140	78,5 80 - 138,5 140	58	31124 __ 00	390,00 €	31124 __ 05	500,00 €
80 x 150	78,5 80 - 148,5 150	58	31125 __ 00	395,00 €	31125 __ 05	505,00 €
80 x 160	78,5 80 - 158,5 160	58	31126 __ 00	405,00 €	31126 __ 05	515,00 €
90 x 90	88,5 90 - 88,5 90	49	31127 __ 00	350,00 €	31127 __ 05	460,00 €
90 x 100	88,5 90 - 98,5 100	52	31128 __ 00	360,00 €	31128 __ 05	470,00 €
90 x 110	88,5 90 - 108,5 110	56	31129 __ 00	365,00 €	31129 __ 05	475,00 €
90 x 120	88,5 90 - 118,5 120	60	31130 __ 00	380,00 €	31130 __ 05	490,00 €
90 x 130	88,5 90 - 128,5 130	60	31131 __ 00	390,00 €	31131 __ 05	500,00 €
90 x 140	88,5 90 - 138,5 140	60	31132 __ 00	400,00 €	31132 __ 05	510,00 €
90 x 150	88,5 90 - 148,5 150	60	31133 __ 00	405,00 €	31133 __ 05	515,00 €
90 x 160	88,5 90 - 158,5 160	60	31134 __ 00	415,00 €	31134 __ 05	525,00 €

Cores de perfil · profile colors
couleurs de profil · colores de perfil

 **Cromado** · Chrome
Chromé · Cromo

 **Preto** · Black
Noir · Negro

Opções de vidro · opciones de cristal
glass options · Options de verre

cm	serigrafado serigrafia screen printed sérigraphié
≤ 100	+ 30 €
101 - 200	+ 60 €
201-300	+ 90 €

 **Avisos** · warning
avertissements · avisos

Altura máxima · maximum height
Hauter maximale · Altura máxima 220cm

Largura máxima · Maximum width
Largeur maximale · Anchura máxima 180cm

Largura máxima porta · door maximum width
Largeur maximale porte · Anchura máxima puerta 88cm

Códigos · codes
codes · códigos

acabamentos vidro
glass finishes
finitions verre
acabados cristal

Pág. 192



Espessura do vidro
Glass thickness
Épaisseur du verre
Espesor del cristal



Vidros c/ outros acabamentos
Glass with other finishes
Verres avec d'autres finitions
Cristal con otros acabados



Limpeza fácil
Easy clean
Facile à nettoyer
Fácil limpieza



Reversível
Réversible
Réversible
Reversible



1.95m altura
1.95m height
1.95m hauteur
1.95m altura

* Preço para perfil cromado e vidro transparente · Price for chromed profile and transparente glass · Prix pour profil chromé et verre transparent · Precio para perfil cromo y cristal transparente

Bases de Duche

Platos de Ducha | Shower bases | Receveurs de douche



As bases de duche CTESI em carga mineral representam o equilíbrio perfeito entre design contemporâneo, durabilidade e conforto. Este material, composto por minerais naturais e resinas de alta qualidade, oferece uma superfície lisa, sem poros e extremamente resistente ao desgaste diário. Com um toque suave e agradável, este material é anti-deslizante, fácil de limpar e altamente higiénico, tornando-se ideal para ambientes onde a segurança e a funcionalidade são essenciais. Permite cortes e acabamentos precisos, oferecendo liberdade na escolha de formatos e tamanhos. Além disso, a base de duche pode ser projetada com a mesma cor dos móveis CTESI da sua casa de banho.

O acabamento e a estética minimalista das bases CTESI conferem um aspeto sofisticado e intemporal, adaptando-se perfeitamente a diferentes estilos de casa de banho.

Los platos de ducha CTESI en carga mineral representan el equilibrio perfecto entre diseño contemporáneo, durabilidad y confort. Este material, compuesto por minerales naturales y resinas de alta calidad, ofrece una superficie lisa, sin poros y extremadamente resistente al desgaste diario.

Con un tacto suave y agradable, este material es antideslizante, fácil de limpiar y altamente higiénico, lo que lo hace ideal para espacios donde la seguridad y la funcionalidad son esenciales.

Permite cortes y acabados precisos, ofreciendo libertad en la elección de formatos y tamaños. Además, el plato de ducha puede diseñarse en el mismo color que los muebles CTESI de tu cuarto de baño.

El acabado y la estética minimalista de los platos CTESI aportan un aspecto sofisticado y atemporal, adaptándose perfectamente a diferentes estilos de baño.

CTESI mineral load shower bases represent the perfect balance between contemporary design, durability, and comfort. This material, made from natural minerals and high-quality resins, offers a smooth, non-porous surface that is extremely resistant to daily wear. With a soft and pleasant touch, this material is non-slip, easy to clean, and highly hygienic, making it ideal for environments where safety and functionality are essential. It allows precise cuts and finishes, providing freedom in the choice of shapes and sizes. Furthermore, the shower base can be designed in the same color as the CTESI furniture in your bathroom.

The minimalist finish and aesthetic of CTESI bases give a sophisticated and timeless look, perfectly adapting to different bathroom styles.

Les receveurs de douche CTESI en charge minérale représentent l'équilibre parfait entre design contemporain, durabilité et confort. Ce matériau, composé de minéraux naturels et de résines de haute qualité, offre une surface lisse, non poreuse et extrêmement résistante à l'usure quotidienne. Avec un toucher doux et agréable, ce matériau est antidérapant, facile à nettoyer et très hygiénique, ce qui le rend idéal pour les environnements où la sécurité et la fonctionnalité sont essentielles. Il permet des découpes et finitions précises, offrant une liberté dans le choix des formes et des tailles. De plus, le receveur de douche peut être conçu avec la même couleur que le mobilier CTESI de votre salle de bain.

La finition et l'esthétique minimaliste des receveurs CTESI confèrent un aspect sophistiqué et intemporel, s'adaptant parfaitement à différents styles de salle de bain.

- 248. STONE
- 249. DEEP
- 250. KORA
- 251. CORNER
- 251. MURAL

Stone

Bases de duche
Shower bases
Receveurs de douche
Platos de ducha



Feito à
sua medida

Made to your measure
Fait sur mesure



acabamento
antiderrapante

Non-slip finish
Finition antiderrapante



A															
B	80	90	100	110	120	130	140	150	160	170	180	190	200	220	240
70	-	1070090__ 161,00€	1070100__ 178,00€	1070110__ 194,00€	1070120__ 211,00€	1070130__ 227,00€	1070140__ 244,00€	1070150__ 260,00€	1070160__ 277,00€	1070170__ 293,00€	1070180__ 310,00€	1070190__ 326,00€	1070200__ 343,00€	1070220__ 405,00€	-
80	1080080__ 164,00€	1080090__ 183,00€	1080100__ 201,00€	1080110__ 220,00€	1080120__ 239,00€	1080130__ 258,00€	1080140__ 277,00€	1080150__ 296,00€	1080160__ 314,00€	1080170__ 333,00€	1080180__ 352,00€	1080190__ 371,00€	1080200__ 390,00€	1080220__ 460,00€	1080240__ 501,00€
90	-	1090090__ 204,00€	1090100__ 225,00€	1090110__ 246,00€	1090120__ 267,00€	1090130__ 288,00€	1090140__ 310,00€	1090150__ 331,00€	1090160__ 352,00€	1090170__ 373,00€	1090180__ 394,00€	1090190__ 415,00€	1090200__ 437,00€	1090220__ 516,00€	1090240__ 562,00€
100	-	-	1010100__ 248,00€	1010110__ 272,00€	1010120__ 296,00€	1010130__ 319,00€	1010140__ 343,00€	1010150__ 366,00€	1010160__ 390,00€	1010170__ 413,00€	1010180__ 437,00€	1010190__ 460,00€	1010200__ 484,00€	1010220__ 572,00€	1010240__ 623,00€
120	-	-	-	-	1012120__ 352,00 €	-	-	-	1012160__ 465,00€	-	-	-	-	1012220__ 683,00	-

GRELHA E VÁLVULA INCLUÍDA | TAPA Y VÁLVULA INCLUIDAS | GRATE AND VALVE INCLUDED | GRILLE ET VALVE INCLUSES

COR | COLOR | COULEUR | COLOR



00
branco
blanco
white
blanc



01
preto
negro
black
noir



02
antracite
antracita
anthracite



03
bege
beige



04
cinzento
gris
grey
gris

GRELHAS COLORIDAS | COLORED GRATES |
GRILLES COLORÉES | REJILLAS EN COLOR



CM

COR

REF.

€

COR

REF.

€

COR

REF.

€

12,5



DB1599941

12,50 €



DB1599943

12,50 €



DB1599945

12,50 €



DB1599947

12,50 €



DB1599949

12,50 €

Deep

Bases de duche
Shower bases
Receveurs de douche
Platos de ducha



Feito à
sua medida

Made to your measure
Fait sur mesure



acabamento
antiderrapant

Non-slip finish
Finition antiderrapante

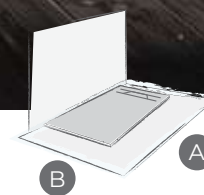

A											
B	100	120	140	150	160	170	180	190	200	220	
70	1170100__ 191,00 €	1170120__ 226,00 €	1170140__ 260,00 €	1170150__ 278,00 €	1170160__ 295,00 €	1170170__ 312,00 €	1170180__ 330,00 €	1170190__ 364,00 €	1170200__ 364,00 €	1170220__ 428,00 €	
80	1180100__ 216,00 €	1180120__ 256,00 €	1180140__ 295,00 €	1180150__ 315,00 €	1180160__ 335,00 €	1180170__ 354,00 €	1180180__ 374,00 €	1180190__ 414,00 €	1180200__ 414,00 €	1180220__ 486,00 €	
90	1190100__ 241,00 €	1190120__ 285,00 €	1190140__ 330,00 €	1190150__ 352,00 €	1190160__ 374,00 €	1190170__ 396,00 €	1190180__ 419,00 €	1190190__ 463,00 €	1190200__ 463,00 €	1190220__ 545,00 €	
100	1110100__ 265,00 €	1110120__ 315,00 €	1110140__ 364,00 €	1110150__ 389,00 €	1110160__ 414,00 €	1110170__ 439,00 €	1110180__ 463,00 €	1110190__ 513,00 €	1110200__ 513,00 €	1110220__ 603,00 €	

VÁLVULA INCLUÍDA | VÁLVULA INCLUIDA | VALVE INCLUDED | VALVE INCLUSES

COR | COLOR | COLOR | COULEUR



00
branco
blanco
white
blanc



01
preto
negro
black
noir



02
antracite
antracita
anthracite



03
bege
beige



04
cinzento
gris
grey
gris

Kora

Base de duche · Shower tray · Receveur de douche · Plato de ducha

A										
B	90	100	120	140	150	160	170	180	200	
70		1870100 __	1870120 __	1870140 __	1870150 __	1870160 __	1870170 __	1870180 __	1870200 __	
		216,00 €	257,00 €	297,00 €	317,00 €	337,00 €	358,00 €	378,00 €	418,00 €	
80		1880100 __	1880120 __	1880140 __	1880150 __	1880160 __	1880170 __	1880180 __	1880200 __	
		245,00 €	291,00 €	337,00 €	360,00 €	383,00 €	407,00 €	430,00 €	476,00 €	
90	1890090 __	1890100 __	1890120 __	1890140 __	1890150 __	1890160 __	1890170 __	1890180 __	1890200 __	
	248,00 €	274,00 €	326,00 €	378,00 €	404,00 €	430,00 €	456,00 €	481,00 €	533,00 €	
100		1810100 __	1810120 __	181010 __		1810160 __		1810180 __	1810200 __	
		303,00 €	360,00 €	418,00 €		476,00 €		533,00 €	591,00 €	

Grelha e válvula incluída · Grid and valve included · Couvercle et valve inclus · Tapa y válvula incluidas

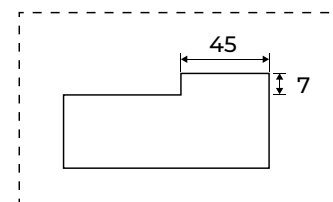

COR | COLOR | COULEUR | COLOR



00
branco
blanco
white
blanc



01
preto
negro
black
noir



02
antracite
anthracite
anthracite



03
beige
beige



04
cinzento
gris
grey
gris

GRELHAS COLORIDAS | COLORED GRATES |
GRILLES COLORÉES | REJILLAS EN COLOR



CM

COR

REF.

€

COR

REF.

€

COR

REF.

€

12,5



DB1599941

12,50 €



DB1599943

12,50 €



DB1599945

12,60 €



DB1599947

12,50 €



DB1599949

12,50 €

Corner



BASE DE DUCHE | SHOWER BASE | RECEVEUR DE DOUCHE | PLATO DE DUCHA

80 x 80	90 x 90	100 x 100
1280080 __	1290090 __	1210100 __
212,00 €	265,00 €	323,00 €

GRELHA E VÁLVULA INCLUÍDA
TAPA Y VÁLVULA INCLUIDAS
GRELHA E VÁLVULA INCLUÍDA
TAPA Y VÁLVULA INCLUIDAS

COR | COLOR | COULEUR | COLOR



00
branco
blanco
white
blanc



01
preto
negro
black
noir



02
antracite
antracita
anthracite



03
bege
beige



04
cinzento
gris
grey
gris

Mural

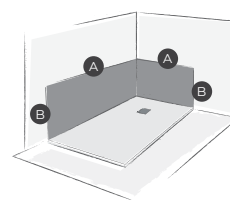

	A	B	80	120	160	240		
60	196008 __	124,00 €	1960120 __	185,00 €	1960160 __	247,00 €	1960240 __	370,00 €
100	1910080 __	247,00 €	1910120 __	370,00 €	1910160 __	493,00 €	1910240 __	739,00 €

COR | COLOR | COULEUR | COLOR



00
branco
blanco
white
blanc



01
preto
negro
black
noir



02
antracite
antracita
anthracite



03
bege
beige



04
cinzento
gris
grey
gris

móveis

espelhos

torneiras

acessórios
de banho

divisórias

bases e
banheiras

sistemas de
instalação

coleções
sanitárias

espaços
públicos

Banheiras acrílicas

Bañeras acrílicas | Acrylic bathtubs | Baignoires en acrylique

Procura um momento de bem-estar e relaxamento? As banheiras CTESI são a opção ideal. De fácil instalação e limpeza, possuem design contemporâneo e suaves curvas que conferem elegância e modernidade à sua casa de banho. Produzidas em acrílico de elevada qualidade e disponíveis em diferentes cores, combinam conforto e praticidade e são perfeitas para quem busca estilo e funcionalidade.

Looking for a moment of well-being and relaxation? CTESI bathtubs are the ideal choice. Easy to install and clean, they feature a contemporary design with smooth curves that add elegance and modernity to your bathroom. Made from high-quality acrylic and available in various colors, they combine comfort and practicality, perfect for those seeking style and functionality.

Vous cherchez un moment de bien-être et de détente ? Les baignoires CTESI sont la solution idéale. Faciles à installer et à nettoyer, elles présentent un design contemporain avec des courbes douces qui apportent élégance et modernité à votre salle de bain.

Fabriquées en acrylique de haute qualité et disponibles en plusieurs couleurs, elles allient confort et praticité, parfaites pour ceux qui recherchent style et fonctionnalité.

¿Busca un momento de bienestar y relajación? Las bañeras CTESI son la opción ideal. De fácil instalación y limpieza, presentan un diseño contemporáneo y curvas suaves que aportan elegancia y modernidad a su cuarto de baño. Fabricadas en acrílico de alta calidad y disponibles en diferentes colores, combinan confort y practicidad, siendo perfectas para quienes buscan estilo y funcionalidad.

248. SORA

250. ZENO





móveis

espelhos

torneiras

acessórios
de banho

divisórias

bases e
banheiras

sistemas de
instalação

coleções
sanitárias

espaços
públicos

Sora



BANHEIRAS ACRÍLICAS | ACRYLIC BATHTUBS | BAINOIRES ACRYLIQUES | BAÑERAS ACRÍLICAS

	75 x 150cm	75 x 160cm	80 x 170cm
Branco brilho Blanco brillo glossy white blanc brillant	DB10010_ _ 1 074,00 €	DB10011_ _ 1 117,00 €	DB10012_ _ 1 177,00 €
Branco mate Blanco mate matte white blanc mat	1 288,00 €	1 330,00 €	1 390,00 €
Cores Cores color couleur	1 350,00 €	1 392,00 €	1 452,00 €

COR | COLOR | COULEUR | COLOR



00
branco brilho
branco brilho
glossy white
blanc brillant



20
branco mate
branco mate
matte white
blanc mat



04
cinzento
gris
grey
gris



05
cashmere
cashmere
cachemire



06
castanho
marrón
brown
marron



12
verde oliva
olive green
vert olive



09
azul claro
light blue
bleu clair



10
azul
blue
bleu



02
antracite
antracita
anthracite



01
preto
negro
black
noir



03
bege
beige



ral
ral



móveis

espelhos

torneiras

acessórios
de banho

divisórias

bases e
banheiras

sistemas de
instalação

coleções
sanitárias

espaços
públicos

Zeno



BANHEIRAS ACRÍLICAS | ACRYLIC BATHTUBS | BAINOIRES ACRYLIQUES | BAÑERAS ACRÍLICAS

	73 x 150cm	78 x 160cm	80 x 170cm	90 x 180cm
Branco brilho Blanco brillo glossy white blanc brillant	DB10030_ _ 1 187,00 €	DB10031_ _ 1 244,00 €	DB10032_ _ 1 297,00 €	DB10033_ _ 1 428,00 €
Branco mate Blanco mate matte white blanc mat	1 401,00 €	1 457,00 €	1 510,00 €	1 641,00 €
Cores Cores color couleur	1 463,00 €	1 519,00 €	1 572,00 €	1 703,00 €

COR | COLOR | COULEUR | COLOR



00
branco brilho
branco brilho
glossy white
blanc brillant



20
branco mate
branco mate
matte white
blanc mat



04
cinzento
gris
grey
gris



05
cashmere
cashmere
cachemire



06
castanho
marrón
brown
marron



12
verde oliva
olive green
vert olive



09
azul claro
light blue
bleu clair



10
azul
blue
bleu



02
antracite
antracita
anthracite



01
preto negro
black
noir



03
bege
beige



ral
ral



móveis

espelhos

torneiras

acessórios
de banho

divisórias

bases e
banheiras

sistemas de
instalação

coleções
sanitárias

espaços
públicos

Calhas de duche

Canaletas de ducha | Shower channels | Caniveaux de douche

ESTÉTICA E EFICÁCIA

As calhas de duche CTESI garantem uma drenagem rápida e eficaz enquanto conferem ao seu espaço de banho uma beleza ímpar, ocultando o sifão e possibilitando que o espaço de duche seja pavimentado com o material da sua eleição.

- Corpo em polipropileno reforçado
- Fornecido com tela impermeabilizante ISOL, para melhor isolamento

AESTHETICS AND EFFICIENCY

CTESI shower channels ensure fast and efficient drainage while giving your bathroom space a unique beauty, hiding the siphon and allowing the shower area to be paved with your chosen material.

- Reinforced polypropylene body
- Supplied with ISOL waterproof membrane for better insulation

ESTHÉTIQUE ET EFFICACITÉ

Les caniveaux de douche CTESI assurent un drainage rapide et efficace tout en conférant à votre espace de bain une beauté unique, en cachant le siphon et en permettant que l'espace de douche soit pavé avec le matériau de votre choix.

- Corps en polypropylène renforcé
- Fourni avec toile d'étanchéité ISOL, pour une meilleure isolation

ESTÉTICA Y EFICIENCIA

Las canaletas de ducha CTESI garantizan un desagüe rápido y eficaz mientras confieren una belleza única a tu espacio de baño, ocultando el sifón y permitiendo pavimentar el espacio de ducha con el material que prefieres.

- Canaleta de ducha con cuerpo de polipropileno
- Con membrana impermeabilizante para un mejor sellado

253. DUAL
254. CRYSTAL
255. NIZAK

257. WAY
258. FLOW
259. SIFÕES DE PAVIMENTO

DUAL

A nova calha de duche CTESI – DUAL – é uma inovação que combina design e engenharia. Garantindo um escoamento ultra eficiente da água do duche, o seu inovador sistema de escoamento duplo (um visível e outro oculto), previne potenciais danos causados por águas infiltradas.

La nueva canaleta de ducha CTESI - DUAL - es una innovación que combina diseño e ingeniería. Garantizando un drenaje ultra eficiente del agua de la ducha, su innovador sistema de drenaje doble (uno visible y otro oculto) evita preocupaciones al prevenir posibles daños causados por aguas infiltradas.

The new CTESI shower channel – DUAL – is an innovation combining design and engineering. Ensuring ultra-efficient drainage of shower water, its innovative dual drainage system (one visible and one hidden) prevents potential damage caused by water infiltration.

La nouvelle caniveau de douche CTESI – DUAL – est une innovation qui combine design et ingénierie. Assurant un drainage ultra efficace de l'eau de la douche, son système innovant de double drainage (un visible et un caché) prévient les dommages potentiels causés par les infiltrations d'eau.

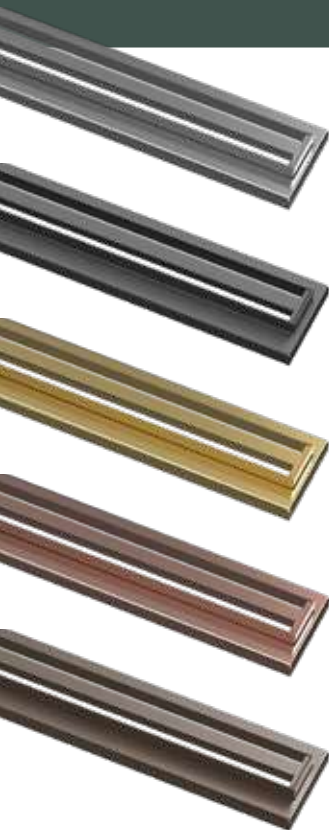

● INOX
STAINLESS STEEL
INOXYDABLE
ACERO





● PRETO MATE
MATTE BLACK
NOIR MAT
NEGRO MATE

● OURO
GOLD
OR
ORO

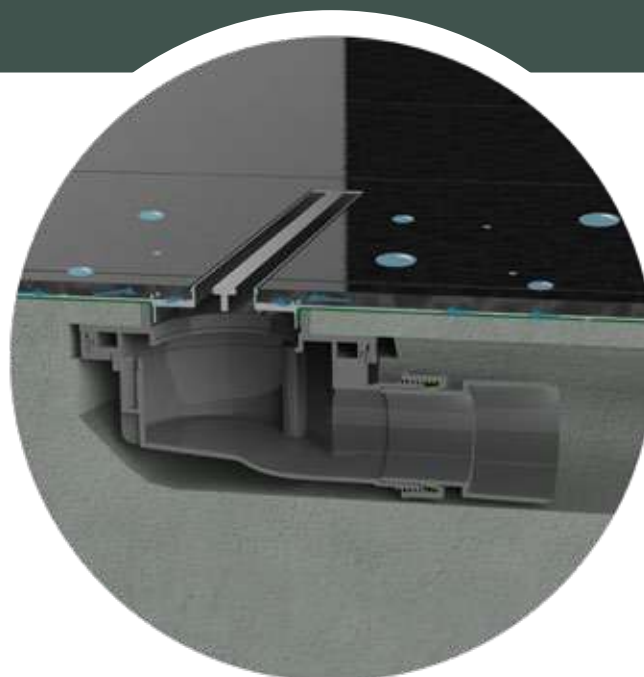
● BRONZE
BRONZE
BRONZE
BRONZE

● GRAFITE MATE
MATTE GRAPHITE
GRAPHITE MAT
GRAFITO MATE



mm		€								
600	BK4024930	180,00	BK4024931	230,00	BK4024932	280,00	BK4024933	280,00	BK4024934	280,00
800	BK4024950	205,00	BK4024951	255,00	BK4024952	305,00	BK4024953	305,00	BK4024954	305,00



GRELHAS EM VIDRO TEMPERADO
REJILLAS DE VIDRIO TEMPLADO



Crystal

As linhas simples e os acabamentos elegantes do vidro, conferem uma sensação única de personalização e leveza.

A elevada resistência aos impactos e a facilidade de limpeza, tornam as grelhas de vidro uma opção higiénica e segura no espaço de banho.

The simple lines and elegant finishes of the glass provide a unique sense of personalization and lightness. The high impact resistance and ease of cleaning make glass grilles a hygienic and safe option for the bathroom space.

Les lignes simples et les finitions élégantes du verre confèrent une sensation unique de personnalisation et de légèreté. La grande résistance aux chocs et la facilité de nettoyage font des grilles en verre une option hygiénique et sûre pour l'espace de bain.

Las líneas simples y los elegantes acabados del vidrio dan un sensación única de personalización y ligereza. La alta resistencia al impacto y la facilidad de limpieza hacen que el Las rejillas de cristal son una opción higiénica y segura en el baño.

CRYSTAL

mm		€		€
400 mm	BK4024310	130,00	BK4024410	130,00
600 mm	BK4024330	150,00	BK4024430	150,00
800 mm	BK4024350	170,00	BK4024450	170,00



PARA PAVIMENTOS ATÉ 12 mm
 Para suelos hasta 12mm
 For floors up to 12 mm
 Pour sols jusqu'à 12 mm

Nizak 12mm

O modelo Nizak é a evolução com uma profundidade de grelha de 12mm, que permite ajustar a altura da espessura do pavimento cerâmico. Esta é uma mudança que proporciona maior liberdade na escolha dos revestimentos, agregando personalidade e sofisticação ao espaço do duche.

The Nizak model is an evolution with a grid depth of 12 mm, allowing adjustment to the height of the ceramic floor thickness. This change provides greater freedom in the choice of coverings, adding personality and sophistication to the shower space.

Le modèle Nizak est une évolution avec une profondeur de grille de 12 mm, qui permet d'ajuster la hauteur de l'épaisseur du revêtement céramique. Ce changement offre une plus grande liberté dans le choix des revêtements, ajoutant personnalité et sophistication à l'espace de la douche.

El modelo Nizak es la evolución con un fondo de rejilla de 12mm, que permite ajustar la altura del espesor del piso cerámico. Se trata de un cambio que aporta mayor libertad a la hora de elegir los revestimientos, aportando personalidad y sofisticación al espacio de ducha.

NIZAK

mm		€		€
400	BK4024810	90,00	BK4024811	105,00
600	BK4024830	110,00	BK4024831	110,00
800	BK4024850	125,00	BK4024851	145,00

*As medidas 330, 500 e 700 estão disponíveis sob encomenda

*The sizes 330, 500, and 700 are available on request.

*Les dimensions 330, 500 et 700 sont disponibles sur commande.

*Los tamaños 330, 500 y 700 están disponibles bajo pedido



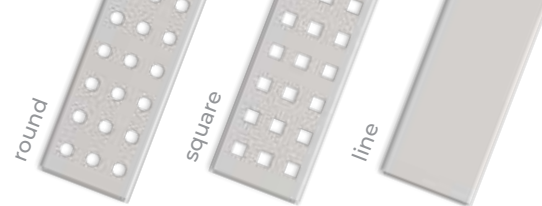

Way



Way Line



mm		€		€		€
330	BK4024002	90,00	BK4024003	110,00	BK4024007	170,00
400	BK4024012	100,00	BK4024013	120,00	BK4024017	180,00
500	BK4024022	110,00	BK4024023	130,00	BK4024027	190,00
600	BK4024032	117,50	BK4024033	137,50	BK4024037	250,00
700	BK4024042	125,00	BK4024043	145,00	BK4024047	260,00
800	BK4024052	130,00	BK4024053	150,00	BK4024057	280,00

- Grelha e Aro em aço inox AISI 304
- Largura de 60 mm
- Grate and frame in AISI 304 stainless steel
- Width of 60 mm
- Grille et cadre en acier inoxydable AISI 304
- Largeur de 60 mm
- Rejilla y marco en acero inoxidable AISI 304
- 60 mm de ancho

Way Square





mm		€		€		€
330	BK4024102	90,00	BK4024103	110,00	BK4024107	170,00
400	BK4024112	100,00	BK4024113	120,00	BK4024117	180,00
500	BK4024122	110,00	BK4024123	130,00	BK4024127	190,00
600	BK4024132	117,50	BK4024133	137,50	BK4024137	250,00
700	BK4024142	125,00	BK4024143	145,00	BK4024147	260,00
800	BK4024152	130,00	BK4024154	150,00	BK4024157	280,00

- Grelha e Aro em aço inox AISI 304
- Largura de 60 mm
- Grate and frame in AISI 304 stainless steel
- Width of 60 mm
- Grille et cadre en acier inoxydable AISI 304
- Largeur de 60 mm
- Rejilla y marco en acero inoxidable AISI 304
- 60 mm de ancho

Way Round



mm		€		€		€
330	BK4024202	90,00	BK4024203	110,00	BK4024207	170,00
400	BK4024212	100,00	BK4024213	120,00	BK4024217	180,00
500	BK4024222	110,00	BK4024223	130,00	BK4024227	190,00
600	BK4024232	117,50	BK4024233	137,50	BK4024237	250,00
700	BK4024242	125,00	BK4024243	145,00	BK4024247	260,00
800	BK4024252	130,00	BK4024253	150,00	BK4024257	280,00

- Grelha e Aro em aço inox AISI 304
- Largura de 60 mm
- Grille et cadre en acier inoxydable AISI 304
- Largeur de 60 mm
- Rejilla y marco en acero inoxidable AISI 304
- 60 mm de ancho
- Grate and frame in AISI 304 stainless steel
- Width of 60 mm

móveis

espelhos

torneiras

acessórios de banho

divisórias

bases e banheiras

sistemas de instalação

coleções sanitárias

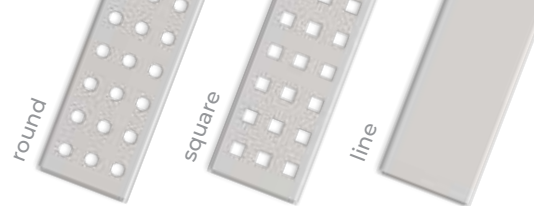

espaços públicos

Flow



Flow Line





mm		€		€
330	BK4024501	70,00	BK4024502	85,00
400	BK4024511	75,00	BK4024512	90,00
500	BK4024521	85,00	BK4024522	100,00
600	BK4024531	90,00	BK4024532	110,00
700	BK4024541	95,00	BK4024542	115,00
800	BK4024551	100,00	BK4024552	120,00

- Grelha e Aro em aço inox AISI 304
- Largura de 60 mm
- Grate and frame in AISI 304 stainless steel
- Width of 60 mm

- Grille et cadre en acier inoxydable AISI 304
- Largeur de 60 mm
- Rejilla y marco en acero inoxidable AISI 304
- 60 mm de ancho

Flow Square





mm		€		€
330	BK4024601	70,00	BK4024602	85,00
400	BK4024611	75,00	BK4024612	90,00
500	BK4024621	85,00	BK4024622	100,00
600	BK4024631	90,00	BK4024632	110,00
700	BK4024641	95,00	BK4024642	115,00
800	BK4024651	100,00	BK4024652	120,00

- Grelha e Aro em aço inox AISI 304
- Largura de 60 mm
- Grate and frame in AISI 304 stainless steel
- Width of 60 mm

- Grille et cadre en acier inoxydable AISI 304
- Largeur de 60 mm
- Rejilla y marco en acero inoxidable AISI 304
- 60 mm de ancho

Flow Round



mm		€		€
330	BK4024701	70,00	BK4024702	85,00
400	BK4024711	85,00	BK4024712	90,00
500	BK4024721	85,00	BK4024722	100,00
600	BK4024731	90,00	BK4024732	110,00
700	BK4024741	95,00	BK4024742	115,00
800	BK4024751	100,00	BK4024752	120,00

- Grelha e Aro em aço inox AISI 304
- Largura de 60 mm
- Grate and frame in AISI 304 stainless steel
- Width of 60 mm

- Grille et cadre en acier inoxydable AISI 304
- Largeur de 60 mm
- Rejilla y marco en acero inoxidable AISI 304
- 60 mm de ancho

Sifões de pavimento

Floor drains | Siphons de sol | Sifón de suelo



360°

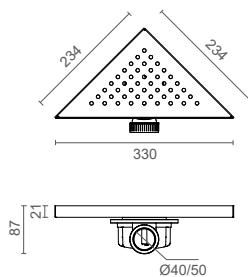

SQUARE

COR	REF.	mm	€
	BK4020711	230 x 230 - Ø40/50mm	50,00
	BK4020712		80,00
	BK4020713		85,00
	BK4020714		85,00
	BK4020715		85,00

- Sifão de pavimento com rotação 360°
- Grelha em aço inox AISI 304
- Para aplicação em espaços de duche

- Floor drain with 360° rotation
- Grate in AISI 304 stainless steel
- For use in shower areas

- Siphon de sol avec rotation à 360°
- Grille en acier inoxydable AISI 304
- Pour application dans les espaces de douche

- Sifón de suelo con rotación 360°
- Rejilla de acero inoxidable AISI 304
- Para uso en áreas de ducha



360°

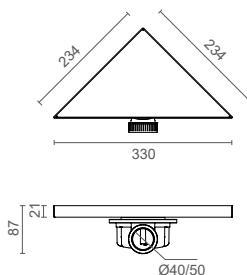

LINE

COR	REF.	mm	€
	BK4020811	230 x 230 - Ø40/50mm	50,00
	BK4020812		80,00
	BK4020813		85,00
	BK4020814		85,00
	BK4020815		85,00

- Sifão de pavimento com rotação 360°
- Grelha em aço inox AISI 304
- Para aplicação em espaços de duche

- Floor drain with 360° rotation
- Grate in AISI 304 stainless steel
- For use in shower areas

- Siphon de sol avec rotation à 360°
- Grille en acier inoxydable AISI 304
- Pour application dans les espaces de douche

- Sifón de suelo con rotación 360°
- Rejilla de acero inoxidable AISI 304
- Para uso en áreas de ducha



360°

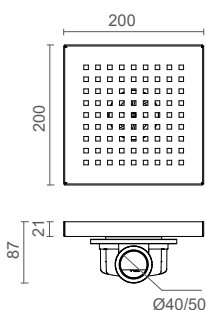

SQUARE

COR	REF.	mm	€
	BK4020701	200 x 200 - Ø40/50mm	50,00
	BK4020702		80,00
	BK4020703		85,00
	BK4020704		85,00
	BK4020705		85,00

- Sifão de pavimento com rotação 360°
- Grelha em aço inox AISI 304
- Para aplicação em espaços de duche

- Floor drain with 360° rotation
- Grate in AISI 304 stainless steel
- For use in shower areas

- Siphon de sol avec rotation à 360°
- Grille en acier inoxydable AISI 304
- Pour application dans les espaces de douche

- Sifón de suelo con rotación 360°
- Rejilla de acero inoxidable AISI 304
- Para uso en áreas de ducha



360°

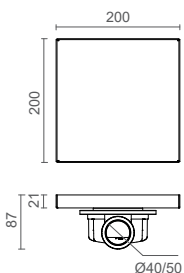

LINE

COR	REF.	mm	€
	BK4020801	200 x 200 - Ø40/50mm	50,00
	BK4020802		80,00
	BK4020803		85,00
	BK4020804		85,00
	BK4020805		85,00

- Sifão de pavimento com rotação 360°
- Grelha em aço inox AISI 304
- Para aplicação em espaços de duche

- Floor drain with 360° rotation
- Grate in AISI 304 stainless steel
- For use in shower areas

- Siphon de sol avec rotation à 360°
- Grille en acier inoxydable AISI 304
- Pour application dans les espaces de douche

- Sifón de suelo con rotación 360°
- Rejilla de acero inoxidable AISI 304
- Para uso en áreas de ducha

Autoclismos

Cisternas



Com os autoclismos CTESI, sustentabilidade e tecnologia andam de mãos dadas. Desenvolvidos para maximizar a poupança de água, estes sistemas reduzem o impacto ambiental sem abdicar do conforto nem da performance.

A tecnologia de descarga eficiente permite um controlo inteligente do consumo hídrico, enquanto os mecanismos internos otimizados garantem menor necessidade de manutenção e maior durabilidade. Esta combinação traduz-se numa solução sustentável e economicamente vantajosa para cada casa de banho. Menos desperdício. Mais desempenho.

As placas de comando CTESI combinam robustez, funcionalidade e um design pensado para se adaptar a qualquer ambiente de casa de banho. Fabricadas com materiais resistentes ao uso intensivo, oferecem uma durabilidade excepcional mesmo com o passar dos tempos.

Mas não é só a resistência que se destaca — a gama CTESI oferece múltiplas opções de acabamento, formatos e cores, permitindo personalizar o espaço de forma harmoniosa e elegante. Desde linhas minimalistas a designs mais arrojados, as placas CTESI adaptam-se a qualquer estilo, seja ele discreto, moderno ou sofisticado.

Avec les réservoirs encastrés CTESI, durabilité et technologie vont de pair. Conçus pour maximiser les économies d'eau, ces systèmes réduisent l'impact environnemental sans compromettre le confort ni la performance.

La technologie de chasse d'eau efficace permet un contrôle intelligent de la consommation d'eau, tandis que les mécanismes internes optimisés garantissent un entretien réduit et une durabilité accrue. Ce combo offre une solution durable et économiquement avantageuse pour chaque salle de bains.

Moins de gaspillage. Plus de performance.

Les plaques de commande CTESI allient robustesse, fonctionnalité et design, pour s'intégrer à tous les styles de salles de bains. Fabriquées avec des matériaux résistants à une utilisation intensive, elles assurent une durabilité exceptionnelle au fil du temps.

Mais leur résistance n'est pas leur seul atout — la gamme CTESI propose de multiples finitions, formats et couleurs, permettant de personnaliser l'espace avec harmonie et élégance. Des lignes minimalistes aux designs les plus audacieux, les plaques CTESI s'adaptent à tous les styles : discrets, contemporains ou sophistiqués.

With CTESI concealed cisterns, sustainability and technology go hand in hand. Designed to maximise water savings, these systems reduce environmental impact without compromising on comfort or performance.

The efficient flush technology ensures smart water consumption control, while optimised internal mechanisms require less maintenance and offer greater durability. This combination results in a sustainable and cost-effective solution for any bathroom.

Less waste. More performance.

CTESI flush plates combine strength, functionality, and a design made to fit any bathroom environment. Made from materials resistant to intensive use, they offer exceptional durability over time.

But durability isn't the only highlight — the CTESI range offers multiple finishes, shapes and colours, allowing you to personalise your space in a harmonious and elegant way. From minimalist lines to bolder designs, CTESI flush plates suit every style: discreet, modern or sophisticated.

Con los sistemas de cisternas CTESI, la sostenibilidad y la tecnología van de la mano. Diseñados para maximizar el ahorro de agua, estos sistemas reducen el impacto ambiental sin renunciar al confort ni al rendimiento.

La tecnología de descarga eficiente permite un control inteligente del consumo hídrico, mientras que los mecanismos internos optimizados garantizan una menor necesidad de mantenimiento y una mayor durabilidad. Esta combinación se traduce en una solución sostenible y económicamente ventajosa para cualquier cuarto de baño.

Menos desperdicio. Más rendimiento.

Los pulsadores CTESI combinan robustez, funcionalidad y un diseño pensado para adaptarse a cualquier ambiente de baño. Fabricados con materiales resistentes al uso intensivo, ofrecen una durabilidad excepcional incluso con el paso del tiempo.

Pero no es solo la resistencia lo que destaca: la gama CTESI ofrece múltiples opciones de acabados, formas y colores, permitiendo personalizar el espacio de manera armoniosa y elegante. Desde líneas minimalistas hasta diseños más atrevidos, los pulsadores CTESI se adaptan a cualquier estilo, ya sea discreto, moderno o sofisticado.

-
- 262. EASY
 - 263. SOLID
 - 264. ESTRUTURAS DE INSTALAÇÃO
 - 268. THEA
 - 270. KALI

Easy

Com pés | Con pies | With feet | Avec pieds

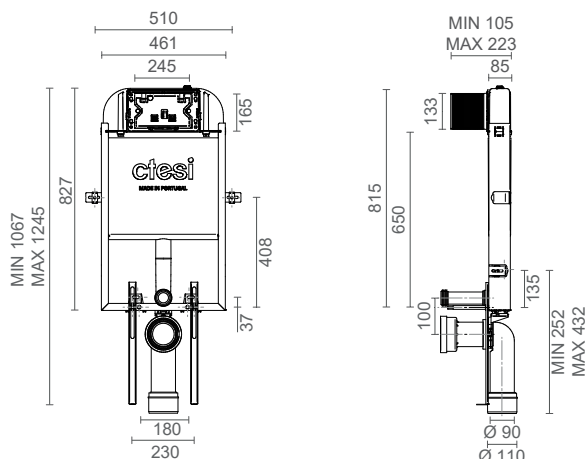

CARACTERÍSTICAS

- Com estrutura para paredes de alvenaria
- Com pés ajustáveis
- Dupla descarga 3/6l; regulável 3/4,5l
- Isolamento anticondensação e acústico em EPS com alvéolos
- Torneira de boia silenciosa
- Profundidade 80 mm
- Reservatório em polipropileno (PP) altamente resistente (Temp. água máx. 25°C)
- Marcação CE: EN 14055
- Eficiência energética: classe A
- Curva de esgoto ajustável em profundidade

FEATURES

- With frame for masonry walls
- With adjustable feet
- Dual flush 3/6l; adjustable to 3/4,5l
- Anti-condensation and acoustic insulation in alveolar EPS
- Silent fill valve
- Depth 80 mm
- High-resistance polypropylene (PP) tank (Max. water temp. 25°C)
- CE marking: EN 14055
- Energy efficiency: class A
- Adjustable waste bend depth

CARACTÉRISTIQUES

- Avec structure pour murs en maçonnerie
- Avec pieds réglables
- Double chasse 3/6l ; réglable à 3/4,5l
- Isolation anti-condensation et acoustique en EPS alvéolé
- Robinet flotteur silencieux
- Profondeur 80 mm
- Réservoir en polypropylène (PP) haute résistance (Temp. max. de l'eau : 25°C)
- Marquage CE : EN 14055
- Efficacité énergétique : classe A
- Coude d'évacuation réglable en profondeur

CARACTERÍSTICAS

- Con estructura para paredes de albañilería
- Con pies ajustables
- Descarga doble 3/6l; ajustable 3/4,5l
- Aislamiento anticondensación y aislamiento acústico en poliestireno con alvéolos
- Grifo flotador silencioso
- Profundidad: 8cm
- Depósito de polipropileno (PP) de alta resistencia (temperatura máxima del agua 25°C)
- Certificación CE: EN 14055
- Certificación Energética: Clase A
- Curva de alcantarillado sanitario ajustable en profundidad



○ BK0200221

140,00€

Solid

Com estrutura e pés | Con estructura y pies | With feet | Avec pieds With structure and feet | Avec structure et pieds

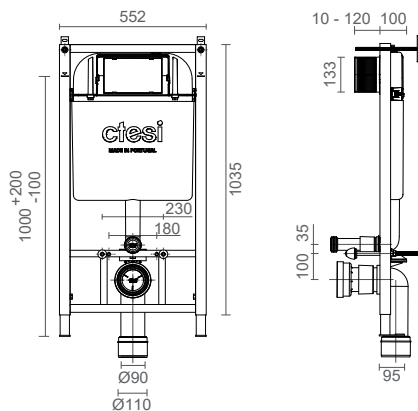

CARACTERÍSTICAS

- Com estrutura para paredes de alvenaria, paredes ligeiras ou calha técnica
- Dupla descarga 3/6l; regulável 3/4,5l
- Isolamento anticondensação e acústico em EPS com alvéolos
- Torneira de boia silenciosa
- Profundidade 80 mm
- Suporta até 400 Kg
- Reservatório em polipropileno (PP) altamente resistente
Temp. água máx. 25°C
- Marcação CE: EN 14055
- Eficiência energética: classe A
- Curva de esgoto ajustável em profundidade
- Altura regulável de 0-300 mm

FEATURES

- With frame for masonry walls, light partitions or technical duct
- Dual flush 3/6l; adjustable to 3/4,5l
- Anti-condensation and acoustic insulation in alveolar EPS
- Silent fill valve
- Depth 80 mm
- Supports up to 400 kg
- High-resistance polypropylene (PP) tank
(Max. water temp. 25°C)
- CE marking: EN 14055
- Energy efficiency: class A
- Adjustable waste bend depth
- Adjustable height from 0 to 300 mm

CARACTÉRISTIQUES

- Avec structure pour murs en maçonnerie, cloisons légères ou goulotte technique
- Double chasse 3/6l ; réglable à 3/4,5l
- Isolation anti-condensation et acoustique en EPS alvéolé
- Robinet flotteur silencieux
- Profondeur 80 mm
- Supporte jusqu'à 400 kg
- Réservoir en polypropylène (PP) haute résistance
(Temp. max. de l'eau : 25°C)
- Marquage CE : EN 14055
- Efficacité énergétique : classe A
- Coude d'évacuation réglable en profondeur
- Hauteur réglable de 0 à 300 mm

CARACTERÍSTICAS

- Con estructura para paredes de albañilería, paredes ligeras o canaletas técnicas
- Con pies ajustables
- Descarga doble 3/6l; ajustable 3/4,5l
- Aislamiento anticondensación y aislamiento acústico en poliestireno con alvéolos
- Grifo flotador silencioso
- Profundidad: 8Cm
- Soporta hasta 400KG
- Depósito de polipropileno (PP) de alta resistencia (temperatura máxima del agua 25°C)
- Certificación CE: EN 14055
- Certificación Energética: Clase A
- Curva de alcantarillado sanitario ajustable en profundidad
- Altura ajustable de 0 a 300mm



móveis

espelhos

torneiras

acessórios de banho

divisórias

bases e banheiras

sistemas de instalação

coleções sanitárias

espaços públicos

○ BK0200240

190,00€

Estruturas de instalação

Estructuras metálicas | Installation structures | Structures d'installation

Com a gama de soluções para estruturas sanitárias embutidas Ctesi tem toda a liberdade para criar o seu espaço de banho com mais espaço livre, num forte compromisso entre a fiabilidade, a eficiência hídrica e o design. Toda a gama foi desenvolvida para oferecer a melhor prestação em utilizações intensivas, quer seja para espaços públicos ou privados.

Avec sa gamme de solutions pour structures sanitaires encastrées, Ctesi offre une liberté totale pour créer un espace de bain plus dégagé, en conciliant fiabilité, efficacité hydrique et design. Toute la gamme a été conçue pour garantir des performances optimales dans des usages intensifs, que ce soit dans des espaces publics ou privés.

With its range of solutions for built-in sanitary structures, Ctesi offers complete freedom to design a bathroom space with more free room, combining reliability, water efficiency and design. The entire range has been developed to ensure top performance in intensive use, whether in public or private spaces.

Con la gama de opciones para estructuras sanitarias empotradas, con un fuerte compromiso entre la fiabilidad, la eficiencia del agua y el diseño, puedes crear tu baño con más espacio libre. Estos productos han sido creados para tener el mejor desempeño en un uso intensivo, tanto en espacios públicos como en espacios privados.



- Estrutura metálica para lavatório suspenso
- Fixação à parede ou ao chão (em paredes ligeiras)
- Fácil instalação e manutenção
- Altura ajustável
- Suporta até 150 kg

- Metal frame for wall-hung washbasin
- Wall or floor fixing (on lightweight walls)
- Easy installation and maintenance
- Adjustable height
- Supports up to 150 kg

- Structure métallique pour lavabo suspendu
- Fixation au mur ou au sol (sur cloisons légères)
- Installation et maintenance faciles
- Hauteur réglable
- Supporte jusqu'à 150 kg

- Estructura metálica para lavabo suspendido
- Fijación a la pared o al suelo (en paredes de cartón yeso)
- Instalación y mantenimiento fáciles
- Altura ajustable
- Soporta hasta 150 kg

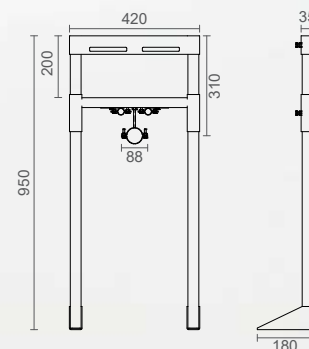

SET

REF.			€
BK0204020	estrutura lavatório · estructura para lavabo structure for washbasin · structure pour lavabo	1	60 199,80

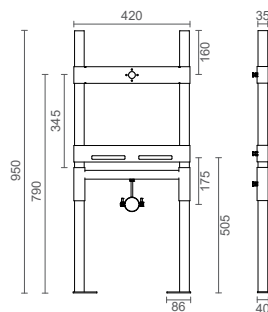

- Estrutura metálica para urinol
- Fixação à parede e ao chão
- Fácil instalação e manutenção
- Altura ajustável
- Suporta até 150 kg

- Structure métallique pour urinoir
- Fixation au mur et au sol
- Installation et maintenance faciles
- Hauteur réglable
- Supporte jusqu'à 150 kg

- Metal frame for urinal
- Wall and floor fixing
- Easy installation and maintenance
- Adjustable height
- Supports up to 150 kg

- Estructura metálica para urinario
- Fijación a la pared o al suelo
- Instalación y mantenimiento fáciles
- Altura ajustable
- Soporta hasta 150 kg

RIG

REF.		€
BK0204030	estrutura urinol • urinal structure structure urinoir • estructura para urinario	254,00

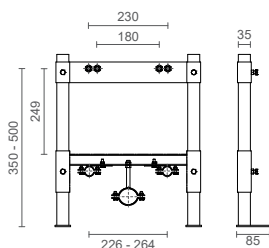

- Estrutura metálica para bidé
- Fixação à parede e ao chão
- Fácil instalação e manutenção
- Altura ajustável
- Suporta até 400 kg

- Structure métallique pour bidet
- Fixation au mur et au sol
- Installation et maintenance faciles
- Hauteur réglable
- Supporte jusqu'à 400 kg

- Metal frame for bidet
- Wall and floor fixing
- Easy installation and maintenance
- Adjustable height
- Supports up to 400 kg

- Estructura metálica para bidet
- Instalación y mantenimiento fácil
- Altura ajustable
- Ancho promedio 420mm
- Suporta hasta 400 kg

LEAD

REF.		€
BK0204010	estrutura de bidé • bidet structure structure de bidet • estructura de bidé	120,60

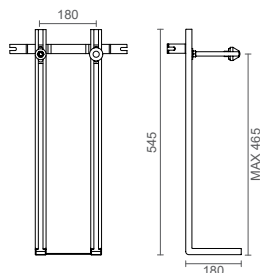

- Estrutura metálica para bidé
- Fácil instalação e manutenção
- Altura ajustável
- Suporta até 400 kg

- Structure métallique pour bidet
- Installation et maintenance faciles
- Hauteur réglable
- Supporte jusqu'à 400 kg

- Metal frame for bidet
- Easy installation and maintenance
- Adjustable height
- Supports up to 400 kg

- Estructura metálica para bidet
- Instalación y mantenimiento fácil
- Altura ajustable
- Suporta hasta 400 kg

LIGHT

REF.		€
BK0204100	estrutura de bidé • bidet structure structure de bidet • estructura de bidé	49,30

móveis

espelhos

torneiras

acessórios
de banho

divisórias

bases e
banheiras

sistemas de
instalação

coleções
sanitárias

espaços
públicos



Placas de comando

Flush plate
plaque de commande
pulsador

Soft Touch



A SUAVIDADE DO TOQUE

As Placas de Descarga THEA e KALI oferecem uma experiência única no seu espaço de banho. O Soft Touch (disponível nas versões Branco e Preto) proporciona um toque aveludado e suave, e adiciona uma camada adicional ao conforto na utilização. Amplifica a estética e oferece uma resistência duradoura.

LA DOUCEUR DU TOUCHER

Les plaques de commande THEA et KALI offrent une expérience unique dans votre espace de salle de bain. Soft Touch (disponible en versions Blanc et Noir) offre un toucher velouté et doux et ajoute une couche supplémentaire de confort d'utilisation. Amplifie l'esthétique et offre une résistance durable.

THE SOFTNESS OF THE TOUCH

THEA and KALI Flush Plates offer a unique experience in your bathroom space. Soft Touch (available in White and Black versions) provides a velvety, soft touch and adds an additional layer of comfort in use. Amplifies aesthetics and offers long-lasting resistance.

LA SUAVIDAD DEL TACTO

Los pulsadores THEA y KALI ofrecen una experiencia única en tu espacio de baño. Soft Touch (disponible en versiones Blanco y Negro) proporciona un tacto suave y aterciopelado y añade una capa adicional de comodidad en su uso. Amplifica la estética y ofrece una resistencia duradera.



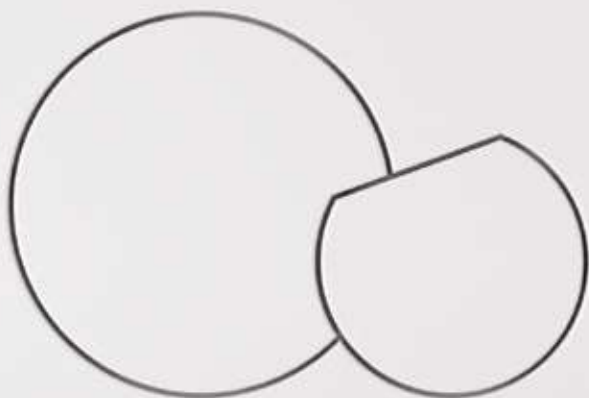

Thea

A placa de comando Thea destaca-se pelos botões redondos, de estética orgânica e contemporânea, que evocam o ciclo da água, promovendo harmonia e interação funcional.

El pulsador Thea se destaca por sus botones redondos, de estética orgánica y contemporánea, que evocan el ciclo del agua, promoviendo armonía e interacción funcional.

Thea Flush Plate stands out for its round buttons, featuring an organic and contemporary design that evokes the water cycle, promoting harmony and functional interaction.

La plaque de commande Thea se distingue par ses boutons ronds, à l'esthétique organique et contemporaine, évoquant le cycle de l'eau et favorisant harmonie et interaction fonctionnelle.

Acabamentos · finishes · finitions · acabados



00
cromado
chrome
chromé
cromo



01
satinox



02
ouro
gold
or
oro



03
ouro escovado
brushed gold
or brossé
oro cepillado



04
ouro mate
matte gold
or mat
oro mate



05
preto mate
matte black
noir mat
negro mate



06
branco mate
matte white
blanc mat
blanco mate



07
grafite mate
graphite matte
graphite mat
grafito mate



08
bronze escovado
brushed bronze
bronze brossé
bronze cepillado



09
bronze
bronze
bronze
bronze



25
cashmere mate
matte cashmere
cashmere mat
cashmere mate



40
vermelho brilho
bright red
rouge briller
rojo brillo



42
azul brilho
bright blue
bleu briller
azul brillo



44
amarelo brilho
bright yellow
jaune briller
amarillo brillo

Thea

Placa de comando
flush plate
plaque de commande
pulsador

70,60€

Cromado · chrome
chrome · cromo

BK0210100 70,60 €

Soft touch

Branco · white
blanc · blanco

BK0210106 76,40 €

Soft touch

Preto · black
noir · negro

BK0210105 76,40 €

Cores · colors
couleurs · colores

BK02101 _ _ + 30%

Metais · metals
métaux · metales

BK02101 _ _ + 40%

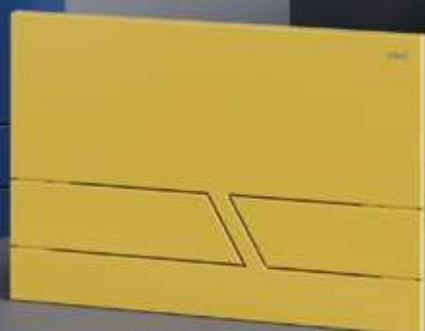
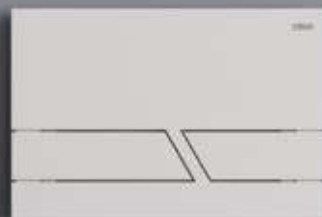



ctesi

Kali

A placa de comando Kali destaca-se pela combinação harmoniosa dos botões e cores vibrantes com a simplicidade funcional. As linhas retas dos botões contribuem para uma estética minimalista e contemporânea.

El pulsador Kali destaca por la armoniosa combinación de pulsadores y colores vibrantes con sencillez funcional. Las líneas rectas de los botones contribuyen a una estética minimalista y contemporánea.

The Kali flush plate stands out for the harmonious combination of buttons and vibrant colors with functional simplicity. The straight lines of the buttons contribute to a minimalist and contemporary aesthetic.

La plaque de commande Kali se distingue par la combinaison harmonieuse de boutons et de couleurs vives avec une simplicité fonctionnelle. Les lignes droites des boutons contribuent à une esthétique minimaliste et contemporaine.

Acabamentos · finishes · finitions · acabados



00
cromado
chrome
chromé
cromo



01
satinox



02
ouro
gold
or
oro



03
ouro escovado
brushed gold
or brossé
oro cepillado



04
ouro mate
matte gold
or mat
oro mate



05
preto mate
matte black
noir mat
negro mate



06
branco mate
matte white
blanc mat
blanco mate



07
grafite mate
graphite matte
graphite mat
grafito mate



08
bronze escovado
brushed bronze
bronze brossé
bronze cepillado



09
bronze
bronze
bronze
bronze



25
cashmere mate
matte cashmere
cashmere mat
cashmere mate



40
vermelho brilho
bright red
rouge briller
rojo brillo



42
azul brilho
bright blue
bleu briller
azul brillo



44
amarelo brilho
bright yellow
jaune briller
amarillo brillo

Kali

Placa de comando
flush plate
plaque de commande
pulsador

70,60€

Cromado · chrome
chrome · cromo

BK02110000 70,60 €

Soft touch

Branco · white
blanc · blanco

BK02110006 76,40 €

Soft touch

Preto · black
noir · negro

BK02110005 76,40 €

Cores · colors
couleurs · colores

BK021100 __ + 30%

Metais · metals
métaux · metales

BK021100 __ + 40%



ctesi

Louça Sanitária

Cerâmica sanitária | Sanitaryware | Sanitaires

A louça cerâmica da CTESI, combina a qualidade dos materiais com a estética ímpar de cada peça CTESI. Escolha as que melhor se adaptam ao estilo da sua casa de banho. As nossas cerâmicas são todas de máxima qualidade, duradouras e muito fáceis de limpar, concedendo uma performance eficiente entre a simplicidade e a qualidade dos materiais aplicados.

La céramique sanitaire CTESI associe la qualité des matériaux à l'esthétique unique de chaque pièce. Choisissez celles qui s'adaptent le mieux au style de votre salle de bains. Toutes nos céramiques sont de qualité supérieure, durables et très faciles à nettoyer, offrant des performances efficaces dans un équilibre parfait entre simplicité et excellence des matériaux.

CTESI ceramic sanitaryware combines high-quality materials with the unique aesthetics of each piece. Choose the ones that best match the style of your bathroom. All our ceramics are of the highest quality, durable, and very easy to clean, delivering efficient performance through a balance of simplicity and material excellence.

Nuestra cerámica sanitaria combina la calidad de los materiales con la estética única de cada pieza CTESI. Elige la que mejor se adapta al estilo de tu baño. Toda nuestra cerámica sanitaria es de la más alta calidad, duradera y muy fácil de limpiar, proporcionando una perfecta armonía entre la sencillez y la calidad de los materiales utilizados.

- 274. TORE SUSPensa
- 276. TORE BACK TO WALL
- 278. DREAM SUSPensa
- 280. DREAM BACK TO WALL
- 282. COMET SUSPensa
- 284. STAR
- 284. NAOS
- 285. ÓRBITA



móveis

espelhos

torneiras

acessórios de banho

divisórias

bases e banheiras

sistemas de instalação

coleções sanitárias

espaços públicos

Tore

Suspenso • Suspended • Suspendu • Suspendid



Sanita

Sanita suspensa

Suspended toilet
Cuvette suspendu
inodoro suspendido



BL7501845

€ 220,00



Bidé

Bidé suspensa

Suspended bidet
Bidet suspendu
Bidé suspendido



BL7501825

€ 170,00

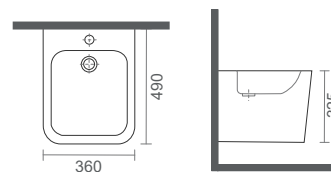
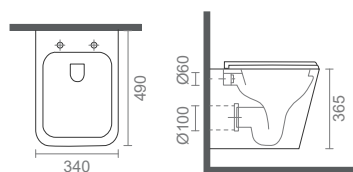



espaços
públicos

coleções
sanitárias

sistemas de
instalação

bases e
banheiras

divisórias

acessórios
de banho

torneiras

espelhos

móveis

Tore

Back to wall



Sanita

Sanita compacta

Compact toilet
Cuvette compacte
inodoro compacto



BL7501840

€ 360,00



Bidé

Bidé

Bidet
Bidet
Bidé



BL7501820

€ 190,00

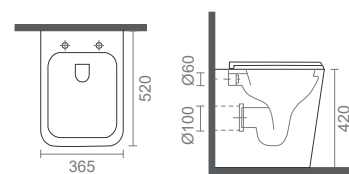
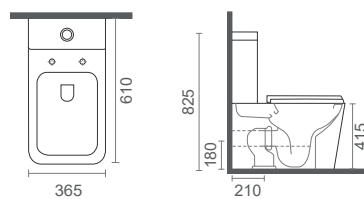



móveis

espelhos

torneiras

acessórios de banho

divisórias

bases e banheiras

sistemas de instalação

coleções sanitárias

espaços públicos

Dream

Suspenso • Suspended • Suspendu • Suspendido



Sanita

Sanita suspensa

Suspended toilet
Cuvette suspendu
inodoro suspendido



BL7501945

€ 215,00



Bidé

Bidé suspenso

Bidé suspendido
Suspended bidet
Bidet suspendu



BL7501925

€ 165,00

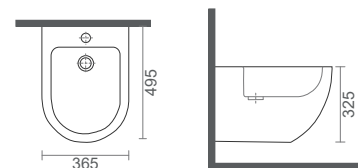
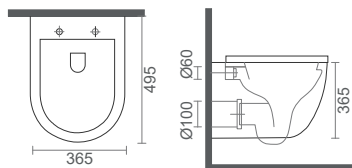



espaços
públicos

coleções
sanitárias

sistemas de
instalação

bases e
banheiras

divisórias

acessórios
de banho

torneiras

espelhos

móveis

Dream

Back to wall



Sanita

Sanita compacta

Compact toilet
Cuvette compacte
Inodoro compacto



BL7501940

€ 335,00



Bidé

Bidé

Bidet



BL7501920

€ 175,00

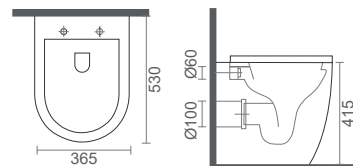
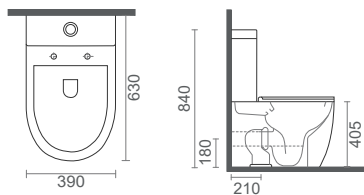



espaços
públicos

coleções
sanitárias

sistemas de
instalação

bases e
banheiras

divisórias

acessórios
de banho

torneiras

espelhos

móveis

Comet

Suspenso • Suspended • Suspendu • Suspendido



Sanita

Sanita suspensa

Suspended toilet
Cuvette suspendu
Inodoro suspendido

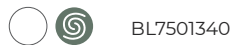

BL7501340

€ 210,00



Bidé

Bidé suspensa

Suspended bidet
Bidet suspendu
Bidé suspendido



BL7501325

€ 160,00

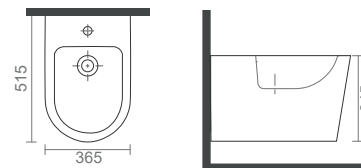
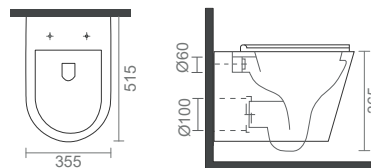



móveis

espelhos

torneiras

acessórios
de banho

divisórias

bases e
banheiras

sistemas de
instalação

coleções
sanitárias

espaços
públicos

Star



Sanita

Sanita compacta
Compact toilet
Cuvette compacte
Inodoro compacto

  BL7500940
€ 250,00

Naos

Compacta | Compact | Compacte



Lavatório suspenso

Lavabo suspenso



 BL7500900

€ 80,00



Sanita

Sanita compacta
Compact toilet
Cuvette compacte
Inodoro compacto

  BL7501740
€ 240,00

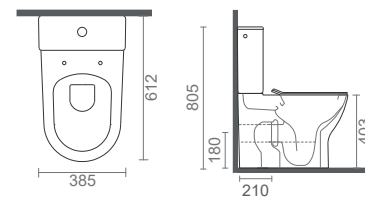
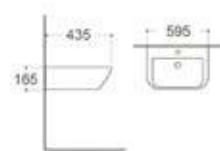
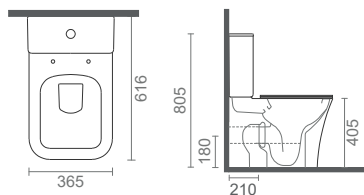

Órbita

Compacta | Compact | Compacte



1

Sanita

Sanita compacta

Compact toilet
Cuvette compacte
Inodoro compacto



BL7500840

€ 125,00

Descarga ao chão
Descarga de suelo



2

Sanita

Sanita compacta

Compact toilet
Cuvette compacte
Inodoro compacto



BL7500845

€ 125,00

Descarga à parede
Descarga de pared



3

Bidé

Bidé Bidet



BL7500820

€ 90,00



4

Lavatório

Lavatório com coluna

Pedestal washbasin
Lavabo sur colonne
Lavabo con columna



BL7500805

€ 85,00



5

Urinol

Urinol

Urinal
Urinair
Urinario



BL7509105

€ 55,00

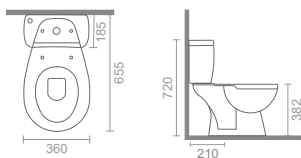

1

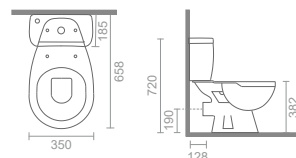

2

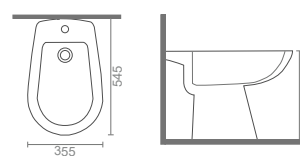

3

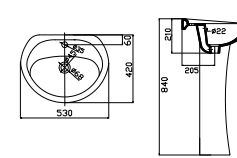

4

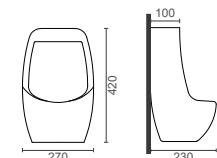

5

Espaços Públicos

Public spaces · Spaces publics · Espacios públicos

Esta gama foi pensada especialmente para pessoas com mobilidade reduzida. Caracterizado pelo seu cuidado em termos de ergonomia, estabilidade e conforto. Os produtos são projetados para que sejam duráveis, mas confortáveis para o uso diário dos espaços de banho inclusivos.

Cette gamme a été spécialement conçue pour les personnes à mobilité réduite. Elle se caractérise par son attention portée à l'ergonomie, à la stabilité et au confort. Les produits sont conçus pour être durables tout en étant confortables pour une utilisation quotidienne dans les espaces de bain inclusifs.

This range was specially designed for people with reduced mobility. It is characterized by its focus on ergonomics, stability, and comfort. The products are designed to be durable yet comfortable for the daily use of inclusive bathroom spaces.

Esta gama ha sido pensada especialmente para personas con movilidad reducida. Se caracteriza por su cuidado en términos de ergonomía, estabilidad y confort. Los productos están diseñados para ser duraderos pero cómodos para el uso diario de los espacios de baño inclusivos.



Clean & Safe



Sanita compacta handicap
compact toilet handicap
cuvette compact handicap
inodoro compacto handicap

360,00€

● BL7502340

Tampo duroplast
duroplast toilet seat
abattant duroplast
tapa inodoro duroplast



Suporte de lavatório
washbasin support
support pour lavabo
soporte lavabo

198,00€

● BL7502305



Suporte de lavatório basculante
reclining washbasin support
support pour lavabo inclinable
soporte lavabo basculante

386,00€

● BL7502306



Lavatório handicap
handicap washbasin
lavabo handicap
lavabo handicap

252,00€

● BL7502300



Fraldário horizontal
horizontal baby changing
table à langer horizontal
cambia pañales horizontal

564,00€

● CT1205900

de acordo c/ norma en 12221
according to en 12221
conforme à la norme en 12221
cumple la norma en 12221



Espelho reclinável
tilt mirror
miroir encadré inclinable
espejo basculante

238,00€

● CT1205155

AISI 304



Fraldário vertical
vertical baby changing
table à langer vertical
cambiador de bebés vertical

564,00€

● CT1205905

de acordo c/ norma en 12221
according to en 12221
conforme à la norme en 12221
cumple la norma en 12221



WIND
Secador de mãos
hand dryer
séche-mains
secadora de manos

636,00€

- CT1205871 636,00€
- CT1205870 636,00€

1750 W CLASSE I IP23 ABS



HD1350
Secador de mãos
hand dryer
séche-mains
secadora de manos

252,00€

- CT1205842 252,00€
- CT1205843 252,00€
- CT1205844 252,00€

AISI 304 1350 W CLASSE I IP23



DT400
Dispensador de papel
paper dispenser
distributeur de papier
distribuidor de papel

59,10€

- CT1205400

400 FOLHAS | 400 HOJAS

AISI 304



DT600
Dispensador de papel
paper dispenser
distributeur de papier
distribuidor de papel

31,10€

- CT1205440

600 FOLHAS | 600 HOJAS

ABS BRANCO
ABS BLANCO



DJI JUMBO
Dispensador de papel
paper dispenser
distributeur de papier
distribuidor de papel

55,10€

- CT1205300

AISI 304 Ø220 mm



DJN JUMBO
Dispensador de papel
paper dispenser
distributeur de papier
distribuidor de papel

25,90

- CT1205340

Ø220 mm ABS BRANCO
ABS BLANCO



Papeira de parede
toilet bin - wall mounted
corbeille à papiers - mural
papelera de baño - pared

108,60€

- CT1205550

AISI 304 25L



Banco de ducha rebatível
folding shower seat
siège de douche rabattable
asiento de ducha foldable

247,10€

CT1205105

AISI 304 120 kg

móveis

espelhos

torneiras

acessórios
de banho

divisórias

bases e
banheiras

sistemas de
instalação

coleções
sanitárias

espaços
públicos



Barra de apoio · grab bar
barre d'appui · asidero recto

47,40€

300	CT1205000	47,40€
400	CT1205002	52,40€
500	CT1205004	58,50€
600	CT1205006	63,30€
800	CT1205008	74,10€

AISI 304



Barra de apoio 90°
grab bar
barre d'appui
asidero recto

71,80€

CT1205015

AISI 304



Barra de apoio 135°
grab bar
barre d'appui
asidero recto

71,80€

CT1205010

AISI 304



Barra de apoio com 3 apoios
grab bar w/ 3 anchoring points
barre d'appui a/ 3 fixations
asidero con 3 fondeaderos

149,70€

600

Esquerda · left
gauche · izquierda CT1205031

AISI 304



Barra de apoio com 3 apoios
grab bar w/ 3 anchoring points
barre d'appui a/ 3 fixations
asidero con 3 fondeaderos

149,70€

600

Direita · right
droite · derecha CT1205030

AISI 304



Barra de apoio rebatível com porta rolo
swing up grab bar w/ paper holder
barre d'appui rabattable a/ porte papier
asidero abatible com portarrollos

146,40€

800

CT1205060

AISI 304



Barra de apoio rebatível
swing up grab bar
barre d'appui rabattable
asidero abatible

146,40€

800

CT1205061

AISI 304



DOC
Lavatório
basin
lavabo
lavabo

105,00€

CT2006700



DOC
Duche
shower
douche
ducha

145,00€

CT2006730

Kit acessório abs + bicha cromada
Abs kit accessories + shower hose
Kit accessoires abs + flexible de douche
Set accesorios en abs + flexible



DSV 12 - 1100ML
Dispensador de sabão vertical
vertical soap dispenser
distributeur savon vertical
dispensador de jabón vertical

46,10€

CT1205200



DSH 12 - 1100ML
Dispensador de sabão horizontal
horizontal soap dispenser
distributeur savon horizontal
dispensador de jabón horizontal

52,50€

CT1205210



Dispensador automático 1100ml
automatic dispenser 1100ml
distributeur automatique 1100ml
dispensador automático 1100ml

44,60€

Sabão/gel + soap/gel CT1205250
savon/gel + jabón/gel

Spray CT1205251



Dispensador de cotovelo 1000ml
elbow dispenser 1000ml
distributeur à coude 1000ml
dispensador del codo 1000ml

40,10€

CT1205281



Dispensador automático de balcão
automatic balcony dispenser
distributeur automatique pour balcon
dispensador automatico de balcón

17,10€

CT1205255



móveis

espelhos

torneiras

acessórios de banho

divisórias

bases e banheiras

sistemas de instalação

coleções sanitárias

espaços públicos



cada

g
o
t
a

conta!

Pequenas ações, grandes economias.

Cada gota cuenta.
Pequeñas acciones, grandes ahorros.

Every drop counts.
Small actions, big savings.

Chaque goutte compte.
Petites actions, grandes économies.

Economia de água

durante a lavagem das mãos em comparação com o uso de uma torneira convencional

Water Saving during hand washing compared to the use of a conventional faucet.
Économie d'eau. Pendant le lavage des mains par rapport à l'utilisation d'un robinet conventionnel
Ahorro de agua al lavarse las manos en comparación con el uso de un grifo convencional

torneira clássica



10
l/min*

torneira temporizada



3
l/min*
aberta | abierta

torneira eletrónica



1
l/min*
aberta | abierta

* Valores aproximados

* Approximate values

* Valeurs approximatives

As torneiras temporizadas e eletrónicas reduzem o desperdício, garantindo um uso eficiente da água.

Com fecho automático, evita desperdícios e promovem economia sustentável.

Timed and electronic taps reduce waste, ensuring efficient water use. With automatic shut-off, they prevent waste and promote sustainable savings.

Les robinets temporisés et électroniques réduisent le gaspillage, garantissant une utilisation efficace de l'eau. Avec fermeture automatique, ils évitent le gaspillage et favorisent une économie durable.

Los grifos temporizados y electrónicos reducen el desperdicio, garantizando un uso eficiente del agua. Con apagado automático, evitan derroches y promueven el ahorro sostenible.



LINE
Torneira lavatório
Washbasin tap
Robinet lavabo
Grifo de lavabo

100,00€

CT5051020



LINE
Torneira misturadora lavatório
Washbasin mixer tap
Mitigeur lavabo
Grifo mezclador de lavabo

147,50€

CT5051025



AXIS
Torneira lavatório
Washbasin tap
Robinet lavabo
Grifo de lavabo

100,00€

CT5051040



AXIS
Torneira misturadora lavatório
Washbasin mixer tap
Mitigeur lavabo
Grifo mezclador de lavabo

147,50€

CT5051045





TY
Torneira lavatório
Washbasin tap
Robinet lavabo
Grifo de lavabo

52,50€

 CT5051000



Torneira banca
Kitchen tap
Mitigeur évier
Grifo mural

72,50€

 CT5051080



Torneira duche exterior
Outdoor shower tap
Robinet douche extérieure
Grifo ducha exterior

79,50€

 CT5051200



Torneira duche interior
Indoor shower tap
Robinet de douche intérieure
Grifo ducha interior

86,50€

 CT5050060



Torneira misturadora duche exterior
Outdoor mixer tap
Mitigeur de douche extérieure
Grifo mezclador ducha exterior

262,70€

 CT5050055



Torneira duche interior
Indoor shower tap
Mitigeur de douche intérieure
Grifo mezclador ducha interior

277,40€

 CT5050065



inclui box de encastrar
includes built-in box
inclus boîtier d'encastrement
incluye box empotrable

móveis

espelhos

torneiras

acessórios
de banho

divisórias

bases e
banheiras

sistemas de
instalação

coleções
sanitárias

espaços
públicos



Torneira de duche hospitalar
Hospital time delay tap
Robinet de douche d'hôpital
Grifo de ducha de hospital

CT5050350

117,80€



Chuveiro anti-vândalo
Anti-vandal shower
Douche anti-vandalisme
Rociador de ducha antivandálico

77,80€

CT5050045



Fluxómetro temporizados sanita exterior
Timed delay flush valve
Déclencheur temporisé pour WC extérieu
Flujómetro temporizado exterior

CT5050070



107,80€



TY
Torneira urinol temporizada
Robinet pour urinoir
Grifo urinol temporizado
Time delay urinal tap

50,00€



simples · simple CT5051120 50,00€

c/ enlace · w/ connection CT5051100 57,50€
a/ connexion · c/ conexión



Tubo para fluxómetro
Pipe for flush valve
Tube pour déclencheur de chasse
Tubo para flujómetro

CT5050250

ajustável
adjustable
réglable
ajustable

54,90€



Bebedouro
Drinking fountain
Fontaine à eau
Fuente

86,00€

CT5050200



jato
jet
jet
chorro



Temporizada pedal
Pedal-operated timed tap
Temporisée à pédale
Grifo de pedal temporizado

111,30€

CT5050110



Misturadora pedal
Pedal-operated mixer tap
Mitigeur à pédale
Mezclador de pedal

129,10€

CT5050115



Bica
Spout
Bec
Caño

25,20€

CT5050180

móveis

espelhos

torneiras

acessórios
de banho

divisórias

bases e
banheiras

sistemas de
instalação

coleções
sanitárias

espaços
públicos



INSIDE

Torneira eletrónica de encastrar para lavatório
Built-in electronic tap for washbasin
Robinet électronique encastré pour lavabo
Grifo electrónico empotrado para lavabo

195,00€

1 água · 1 way
1 sortie · 1 salida **CT2300061** 195,00€

2 águas · 2 ways
2 sorties · 2 salidas **CT2300060** 240,00€



BLOK

Torneira eletrónica de encastrar p/ lavatório
Built-in electronic tap for washbasin
Robinet électronique encastré pour lavabo
Grifo electrónico empotrado para lavabo

205,00€

1 água · 1 way
1 sortie · 1 salida **CT2300051** 205,00€

2 águas · 2 ways
2 sorties · 2 salidas **CT2300050** 250,00€



PIXEL

Torneira eletrónica para lavatório
Electronic tap for washbasin
Robinet électronique pour lavabo
Grifo electrónico para lavabo

180,00€

1 água · 1 way
1 sortie · 1 salida **CT2300300** 180,00€

2 águas · 2 ways
2 sorties · 2 salidas **CT2300305** 225,00€



KEEN

Torneira eletrónica para lavatório
Electronic tap for washbasin
Robinet électronique pour lavabo
Grifo electrónico para lavabo

160,00€

1 água · 1 way
1 sortie · 1 salida **CT2300070** 160,00€

2 águas · 2 ways
2 sorties · 2 salidas **CT2300071** 205,00€



KEEN

Torneira eletrónica para lavatório alto
Electronic tap for tall washbasin
Robinet électronique pour lavabo haut
Grifo electrónico para lavabo alto

250,00€

1 água · 1 way
1 sortie · 1 salida **CT2300080** 250,00€

2 águas · 2 ways
2 sorties · 2 salidas **CT2300081** 295,00€



SELF

Torneira eletrónica para lavatório
Electronic tap for washbasin
Robinet électronique pour lavabo
Grifo electrónico para lavabo

150,00€



1 água · 1 way
1 sortie · 1 salida **CT2300075** 150,00€

2 águas · 2 ways
2 sorties · 2 salidas **CT2300076** 195,00€



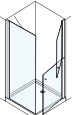

Cabine de duche 2 portas + 1 fixo · Shower enclosure 2 doors + 1 fixed panel
Cabine de douche 2 portes + 1 panneau fixe · Mampara de ducha 2 puertas + 1 fijo

	cm	Ajuste adjustment réglage ajuste	Abertura opening ouverture apertura	REF	€ *
	70 x 70	68,5 x 70 68,5 x 70	62	30600 __ 00	730,00 €
	75 x 75	73,5 x 75 73,5 x 75	67	30601 __ 00	760,00 €
	80 x 80	78,5 x 80 78,5 x 80	72	30602 __ 00	780,00 €
	90 x 90	88,5 x 90 88,5 x 90	82	30603 __ 00	830,00 €

Cabine de duche 2 portas + 1 fixo · Shower enclosure 2 doors + 1 fixed panel
Cabine de douche 2 portes + 1 panneau fixe · Mampara de ducha 2 puertas + 1 fijo

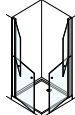
	cm	Ajuste adjustment réglage ajuste	Abertura opening ouverture apertura	REF	€ *
	70 x 70	68,5 x 70 68,5 x 70	88	30604 __ 00	930,00 €
	75 x 75	73,5 x 75 73,5 x 75	95	30605 __ 00	950,00 €
	80 x 80	78,5 x 80 78,5 x 80	102	30606 __ 00	980,00 €
	90 x 90	88,5 x 90 88,5 x 90	116	30607 __ 00	1 030,00 €

Frontal de duche 2 portas · Shower front 2 doors
Frontal de douche 2 portes · Frontal de ducha 2 puertas

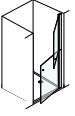
	cm	Ajuste adjustment réglage ajuste	Abertura opening ouverture apertura	REF	€ *
	70	68 71	58	30608 __ 00	530,00 €
	75	73 76	63	30609 __ 00	540,00 €
	80	78 81	68	30610 __ 00	555,00 €
	85	83 86	73	30611 __ 00	565,00 €
	90	88 91	78	30612 __ 00	580,00 €
	95	93 96	83	30613 __ 00	590,00 €
	100	98 101	88	30614 __ 00	605,00 €

Frontal de duche 4 portas · Shower front 4 doors
Frontal de douche 4 portes · Frontal de ducha 4 puertas

	cm	Ajuste adjustment réglage ajuste	Abertura opening ouverture apertura	REF	€ *
	70	68 71	57	30615 __ 00	690,00 €
	75	73 76	62	30616 __ 00	700,00 €
	80	78 81	67	30617 __ 00	710,00 €
	85	83 86	72	30618 __ 00	730,00 €
	90	88 91	77	30619 __ 00	740,00 €
	95	93 96	82	30620 __ 00	750,00 €
	100	98 101	87	30621 __ 00	770,00 €

Opções de vidro · opciones de cristal
glass options · Options de verre

cm	serigrafado serigrafia screen printed sérigraphié
≤ 100	+ 30 €
101 - 200	+ 60 €
201-300	+ 90 €

20

Variação de medidas · size variation
variation des mesures · variación de medidas

Cada 10cm (altura/largura) acrescentar
Add every 10 cm (height/width) 30 €
Ajouter tous les 10cm (hauteur/largeur)
Cada 10cm (altura/ancho) aumentar

Códigos · codes
codes · códigos

acabamentos vidro
glass finishes
finitions verre
acabados cristal

Pág. 192



Espessura do vidro
Glass thickness
Épaisseur du verre
Espesor del cristal



Vídras c/ outros acabamentos
Glass with other finishes
Verres avec d'autres finitions
Cristal con otros acabados



Limpeza fácil
Easy clean
Facile à nettoyer
Fácil limpieza



Reversível**
Réversible
Réversible
Reversible



2m altura
2m height
2m hauteur
2m altura



Haste de fixação incluída
Fixing rod included
Tige de fixation incluse
Varilla de fijación incluida

* Preço para perfil cromado e vidro transparente · Price for chromed profile and transparente glass · Prix pour profil chromé et verre transparente · Precio para perfil cromo y cristal transparente

** Reversível somente para vidro transparente · Reversible for transparent glass only · Réversible uniquement pour verre transparent · Reversible solo para vidrio transparente



condições gerais de venda | General Terms of Sale | Conditions Générales de Vente | condiciones generales de venta |

As condições gerais de venda adiante definidas aplicam-se a todas as transações comerciais entre a Barros & Moreira, S.A. detentora da marca registada CTESI, e doravante designada por CTESI, e os seus Clientes, as quais são consideradas aceites a partir do momento em que remete uma encomenda à CTESI.

The general terms of sale set forth below apply to all commercial transactions between Barros & Moreira, S.A., holder of the registered trademark CTESI, hereinafter referred to as CTESI, and its Customers, which are deemed accepted from the moment an order is placed with CTESI.

Les conditions générales de vente définies ci-après s'appliquent à toutes les transactions commerciales entre Barros & Moreira, S.A., titulaire de la marque déposée CTESI, ci-après dénommée CTESI, et ses Clients, lesquelles sont considérées comme acceptées à partir du moment où une commande est passée à CTESI.

Las condiciones generales de venta definidas abajo se aplican a todas las transacciones comerciales entre Barros & Moreira, propietaria de la marca CTESI, en adelante mencionada cómo CTESI y sus Clientes, que son consideradas aceptadas desde el momento en que se realiza el orden a CTESI.

encomendas e catálogos | órdenes y catálogos | Orders and Catalogs | Commandes et Catalogues

Só serão consideradas as encomendas que sejam efetuadas por email, através do gestor comercial ou no nosso site. As encomendas registadas não podem ser canceladas ou alteradas 48h após a receção, em artigos especiais.

A CTESI reserva o direito de anular ou reter encomendas pendentes em caso de incumprimento por parte do Cliente. Quando se trate de artigos especiais e/ou personalizados, o Cliente compromete-se em fornecer à CTESI todos os elementos necessários à boa e correta execução da encomenda.

As indicações nos nossos catálogos são meramente orientadoras e nunca vinculativas. As cores apresentadas nos catálogos podem variar da realidade, devido às variações de impressão e uso do catálogo. A CTESI reserva-se o direito de em qualquer momento e sem aviso prévio proceder à alteração de materiais, cores e/ou especificações descritas.

Only orders placed by email, through the sales manager, or on our website will be considered. Registered orders cannot be canceled or changed 48 hours after receipt, for special items.

CTESI reserves the right to cancel or hold pending orders in case of customer non-compliance. For special and/or customized items, the Customer commits to providing CTESI with all necessary elements for the proper execution of the order.

The information in our catalogs is for guidance only and is never binding. The colors shown in the catalogs may vary from reality due to printing variations and catalog use. CTESI reserves the right to change materials, colors, and/or specifications described at any time without prior notice.

Seules seront prises en compte les commandes effectuées par email, via le gestionnaire commercial ou sur notre site internet. Les commandes enregistrées ne peuvent être annulées ou modifiées 48h après réception, pour les articles spéciaux.

CTESI se réserve le droit d'annuler ou de retenir les commandes en attente en cas de non-respect de la part du Client. En cas d'articles spéciaux et/ou personnalisés, le Client s'engage à fournir à CTESI tous les éléments nécessaires à la bonne et correcte exécution de la commande.

Les indications présentes dans nos catalogues sont données à titre indicatif et ne sont jamais contraignantes. Les couleurs présentées dans les catalogues peuvent varier de la réalité en raison des variations d'impression et de l'utilisation du catalogue. CTESI se réserve le droit de modifier à tout moment et sans préavis les matériaux, couleurs et/ou spécifications décrites.

Solo se considerarán las órdenes realizadas por correo electrónico, a través de uno de nuestros gerentes de venta o a través de nuestra página web. Las órdenes registradas de productos especiales no se pueden cancelar ni sufrir cambios 48h después de su recepción.

CTESI se reserva el derecho de cancelar o retener órdenes pendientes en caso de incumplimiento por parte del Cliente. El Cliente se compromete a proporcionar a CTESI todos los elementos necesarios a la ejecución del orden, siempre que se trate de productos especiales y/o personalizados.

La información en nuestros catálogos es solamente orientativa y no vinculante.

prazos | plazos | Deadlines | Délais

A confirmação da encomenda e prazos de entrega são sempre em função da disponibilidade de stock. Não é passível qualquer tipo de indemnização ao Cliente, devido a atrasos na entrega de encomendas por rutura de stock. Os atrasos de entrega que, por motivo alheio à sua vontade ou de força maior, não permitam à CTESI dar satisfação aos prazos acordados, não são justificativos para a anulação da encomenda por parte do Cliente.

Order confirmation and delivery times are always subject to stock availability. No compensation is payable to the Customer due to delays in order delivery caused by stock shortages. Delivery delays that, due to reasons beyond CTESI's control or force majeure, prevent CTESI from meeting the agreed deadlines, do not justify order cancellation by the Customer.

La confirmation de la commande et les délais de livraison dépendent toujours de la disponibilité des stocks. Aucun type d'indemnisation ne sera accordé au Client en cas de retard de livraison dû à une rupture de stock. Les retards de livraison qui, pour des raisons indépendantes de sa volonté ou de force majeure, empêchent CTESI de respecter les délais convenus, ne justifient pas l'annulation de la commande par le Client.

La confirmación del orden y de los plazos de entrega siempre dependen de la disponibilidad del stock. El Cliente no recibirá cualquier tipo de compensación por retrasos en la entrega del orden o por falta de stock. Los retrasos en la entrega causados por motivos fortuitos o ajenos a CTESI que no le permitan cumplir con los plazos acordados no son justificación para que el Cliente anule el orden.

Prices | Prix | Preços | Precios

The prices applied shall be those listed in the current Price List, available online at www.ctesi.pt, and are valid except for typographical or computer errors. All sales are subject to the applicable legal VAT rate. The Price List may be updated without prior notice.

Les prix appliqués seront ceux indiqués dans la Table des Prix en vigueur, disponible en ligne sur www.ctesi.pt, et sont valables sauf erreur typographique ou informatique. Toutes les ventes sont soumises au taux légal de TVA en vigueur. La Table des prix peut être mise à jour sans préavis.

Os preços praticados serão os constantes da Tabela de Preços em vigor, disponível on-line em www.ctesi.pt, e são válidos salvo erro tipográfico ou informático. Todas as vendas estão sujeitas à taxa legal do IVA em vigor. A Tabela de preços pode ser atualizada sem aviso prévio.

Los precios cobrados serán los presentados en el Listado de Precios vigente y son válidos salvo error tipográfico. El Listado de Precios puede sufrir cambios sin aviso previo.

Deliveries | Livraisons | entregas | entregas

A mercadoria considera-se entregue ao Cliente após a descarga nas suas instalações ou local indicado por ele e a assinatura de confirmação da sua boa receção na respetiva Guia de Remessa, de Transporte, ou qualquer outro documento válido que acompanhe a mercadoria, assim como dispositivo eletrónico certificado para o efeito. Todos os artigos frágeis (Ex: Cabines, Bases de Chuveiro, Móveis, Vidros, Espelhos, Lavatórios Vidro, Loixa Sanitária, etc.) têm obrigatoriamente de ser verificados no ato da entrega e, caso seja encontrada alguma anomalia, o Cliente pode aceitar ou recusar a entrega, devendo obrigatoriamente fazer referência à anomalia encontrada, na respetiva guia ou dispositivo que acompanhe a mercadoria. Após a receção e assumindo que existe alguma anomalia, o Cliente deverá efetuar uma reclamação por escrito, no período de 24 horas, para o nosso Serviço Pós-Venda (spv@barros-moreira.pt), evidenciando com fotos e na guia de transporte ou dispositivo eletrónico, a anomalia encontrada. Se tal procedimento não for cumprido, a mercadoria é considerada entregue em perfeitas condições e não poderá ser imputada à CTESI qualquer tipo de responsabilidades ou pedidos de indemnização. Os carimbos, “sujeito a verificação” ou “sujeito a conferência”, não são válidos em caso de reclamação e/ou devolução. As entregas poderão ser satisfeitas por entregas parciais.

The goods are considered delivered to the Customer after unloading at their premises or at a location indicated by them, and upon signature confirming receipt on the relevant Delivery Note, Transport document, or any other valid document accompanying the goods, as well as on a certified electronic device for this purpose. All fragile items (e.g., cabins, shower bases, furniture, glass, mirrors, glass washbasins, sanitary ware, etc.) must be inspected upon delivery, and if any anomaly is found, the Customer may accept or refuse the delivery, and must mandatorily note the anomaly on the relevant delivery note or device accompanying the goods. After receipt and assuming an anomaly exists, the Customer must submit a written complaint within 24 hours to our After-Sales Service (spv@barros-moreira.pt), providing photographic evidence and noting the anomaly on the transport document or electronic device. If this procedure is not followed, the goods will be considered delivered in perfect condition, and no responsibility or claims for compensation can be attributed to CTESI. Stamps such as “subject to verification” or “subject to inspection” are not valid in case of complaint and/or return. Deliveries may be fulfilled by partial shipments.

La marchandise est considérée comme livrée au Client après le déchargement dans ses locaux ou à un lieu indiqué par celui-ci, et la signature du document de confirmation de réception sur le Bon de Livraison, de Transport ou tout autre document valide accompagnant la marchandise.

Au moment de la réception, le Client doit vérifier si la marchandise présente un défaut dû au transport, en notant l'anomalie sur le document de livraison et en informant immédiatement CTESI par écrit. Si cette procédure n'est pas respectée, la marchandise sera considérée comme livrée en parfait état et CTESI ne pourra être tenue responsable d'aucune réclamation ou demande d'indemnisation.

Le tampon « sous réserve de vérification » n'est pas valable en cas de réclamation ou de retour. Les livraisons peuvent être effectuées partiellement.

La mercancía se considera entregada al Cliente después de descargarla en sus instalaciones o en un lugar indicado por el mismo y después de firmar el documento de confirmación de recepción de la Guía de Entrega, Transporte o de cualquier otro documento válido que acompañe a la mercancía.

Al recibir la mercancía, el Cliente debe comprobar si esta presenta algún defecto derivado del transporte, anotando la anomalía en el documento de entrega e informando de inmediato a CTESI por escrito. En caso de que no se siga ese procedimiento, la mercancía se considerará como entregada en perfecto estado y CTESI no será imputable de ningún tipo de responsabilidad o pedido de indemnización. El sello “sujeto a verificación” no es válido en caso de reclamación o devolución.

Las entregas se pueden realizar de forma parcial.

Condições de pagamento | Payment terms | Conditions de paiement | Condiciones de pago

As condições de pagamento e os descontos financeiros, se aplicáveis, serão acordadas entre a CTESI e o Cliente.

Todas as faturas terão de ser liquidadas dentro dos prazos, salvo prévio acordo escrito e a mercadoria fornecida é da propriedade da CTESI até ao pagamento integral do valor da fatura, por parte do Cliente. A eventual existência de situações pendentes não será aceite, em nenhum caso, como justificação para o não cumprimento dos prazos de pagamento de qualquer fatura.

The payment terms and financial discounts, if applicable, will be agreed upon between CTESI and the Customer.

All invoices must be settled within the deadlines, unless a prior written agreement exists, and the supplied goods remain the property of CTESI until full payment of the invoice amount by the Customer.

The existence of any pending situations will not, under any circumstances, be accepted as justification for failure to meet the payment deadlines of any invoice.

Les conditions de paiement et les remises financières, le cas échéant, seront convenues entre CTESI et le Client.

Toutes les factures devront être réglées dans les délais, sauf accord écrit préalable, et la marchandise fournie reste la propriété de CTESI jusqu'au paiement intégral du montant de la facture par le Client.

L'existence éventuelle de situations en suspens ne sera en aucun cas acceptée comme justification du non-respect des délais de paiement de toute facture.

Las condiciones de pago y los descuentos se acordarán entre CTESI y cada Cliente, siempre que sean aplicables.

Todas las facturas deben liquidarse dentro de los plazos definidos, salvo acuerdo previo escrito y toda la mercancía es propiedad de CTESI hasta que el cliente realice el pago total de la factura. La eventual existencia de situaciones pendientes no se aceptará, en ningún caso, como justificación del incumplimiento de los plazos de pago de cualquier factura.

Reclamações | claims | reclamaciones | réclamations

Todas as reclamações deverão ser apresentadas por escrito no prazo de 10 dias imediatos, a contar da data de entrega da mercadoria.

As reclamações só serão aceites após a análise e o aval positivo do nosso Serviço Pós-Venda. A CTESI só é responsável pela reparação ou reposição por troca, em última análise, de produto igual ou similar, em caso de produtos descontinuados.

Não serão consideradas as reclamações que não sejam acompanhadas pela cópia da fatura ou documento do Cliente. Não serão consideradas reclamações de produtos em que tenham sido introduzidas modificações pelo Cliente.

Em caso negativo, e o material se encontrar nas nossas instalações em condições de ser comercializado, o Cliente tem 10 dias para recolher o respetivo material, a contar da data da nossa comunicação.

All complaints must be submitted in writing within 10 calendar days from the date of delivery of the goods.

Complaints will only be accepted after analysis and positive approval from our After-Sales Service.

CTESI is only responsible for repair or replacement, as a last resort, with an identical or similar product in the case of discontinued items.

Complaints not accompanied by a copy of the invoice or Customer document will not be considered.

Complaints regarding products modified by the Customer will not be accepted.

If rejected, and if the material is held at our facilities in marketable condition, the Customer has 10 days to collect the respective material from the date of our communication.

Todas las reclamaciones deben presentarse por escrito dentro de los 10 días útiles siguientes a la fecha de entrega de la mercancía.

Estas quejas están sujetas a un análisis de nuestro Servicio Postventa, que las aceptará o no. CTESI solo es responsable por la reparación o, en último caso, reemplazo del producto por otro artículo igual o por otro similar, en caso de que se trate de un producto descontinuado o se considerarán las reclamaciones que no estén acompañadas de una copia de la factura o documento válido del Cliente.

No se aceptarán reclamaciones de productos que hayan sufrido cambios realizados por el Cliente.

En caso de que la reclamación sea rechazada, el material se encontrará en nuestras instalaciones en perfectas condiciones de ser vendido y el Cliente tiene 10 días para recogerlo, a partir de la fecha en que se lo comunicamos.

Toute réclamation doit être présentée par écrit dans un délai de 10 jours calendaires à compter de la date de livraison de la marchandise.

Les réclamations ne seront acceptées qu'après analyse et approbation positive de notre Service Après-Vente.

CTESI n'est responsable que de la réparation ou du remplacement, en dernier recours, par un produit identique ou similaire en cas de produits discontinués.

Les réclamations non accompagnées d'une copie de la facture ou d'un document client ne seront pas prises en compte.

Les réclamations concernant des produits ayant subi des modifications de la part du Client ne seront pas considérées.

En cas de refus, et si le matériel se trouve dans nos locaux en état commercialisable, le Client dispose de 10 jours pour récupérer le matériel à compter de la date de notre communication.

devoluções | returns | devoluciones | retours

Não serão aceites devoluções comerciais sem pedido de aprovação prévio por escrito.

Não serão aceites devoluções de produtos que tenham marcas de uso, sujidade, danos ou qualquer outro sinal que o desvalorize ou que indique negligência por parte do Cliente. Não serão consideradas devoluções em que tenham sido introduzidas modificações pelo Cliente.

Todas as devoluções que possam suceder estão sujeitas à nossa prévia aprovação por escrito. As devoluções aceites podem estar sujeitas a gastos com a receção, inspeção, testes e desvalorização.

Quando o Cliente pretender fazer uma devolução deverá ter em conta que a mercadoria viaja por sua conta e risco, a quem compete a responsabilidade pelo seguro respetivo. Esta é uma responsabilidade exclusiva do Cliente à qual a CTESI se iliba em caso de dano, extravio ou roubo.

Todas as peças que sejam enviadas para devolução devem estar devidamente embaladas e protegidas, com preferência pela embalagem original, de qualquer dano que possa proceder do seu transporte, e estarem acompanhados dos manuais, acessórios e/ou softwares, caso seja aplicável.

Commercial returns will not be accepted without prior written approval.

Returns of products showing signs of use, dirt, damage, or any other marks that devalue the product or indicate negligence on the part of the Customer will not be accepted.

Returns of products that have been modified by the Customer will not be considered.

All potential returns are subject to our prior written approval. Accepted returns may be subject to charges for receipt, inspection, testing, and depreciation.

When the Customer intends to make a return, they should be aware that the goods travel at their own risk and expense, with responsibility for the corresponding insurance lying with the Customer. CTESI disclaims any liability in case of damage, loss, or theft.

All parts sent for return must be properly packaged and protected, preferably in the original packaging, against any damage that may occur during transport, and must be accompanied by manuals, accessories, and/or software, if applicable.

No se aceptan devoluciones comerciales.

No se aceptan devoluciones de productos que contengan marcas de uso, que presenten suciedad, defectos o cualquier otra marca que lo devalúe o que indique negligencia por parte del Cliente. No se aceptan devoluciones de productos que hayan sufrido cambios realizados por el Cliente. Todas las devoluciones que puedan ocurrir están sujetas a nuestra aprobación previa y por escrito. A las devoluciones aprobadas pueden añadirse costes de recepción, inspección, pruebas y devaluación del producto.

Siempre que el Cliente desee realizar una devolución, este será responsable del transporte y seguro de la mercancía. Esta es una responsabilidad del Cliente, por lo que CTESI queda exenta de toda y cualquier responsabilidad en caso de posibles daños, pérdida o robo de la mercancía.

Todos los productos enviados para devolución deben estar debidamente embalados y protegidos, preferiblemente en el embalaje original, con el objetivo de evitar cualquier daño que pueda resultar del transporte, y también acompañados de manuales, accesorios y/o softwares, siempre que aplicable.

Aucun retour commercial ne sera accepté sans demande d'approbation préalable écrite.

Les retours de produits présentant des traces d'utilisation, salissures, dommages ou tout autre signe dévalorisant le produit ou indiquant une négligence de la part du Client ne seront pas acceptés.

Les retours de produits modifiés par le Client ne seront pas pris en compte.

Tous les retours possibles sont soumis à notre approbation écrite préalable. Les retours acceptés peuvent être soumis à des frais de réception, inspection, tests et dépréciation.

Lorsque le Client souhaite effectuer un retour, il doit prendre en compte que la marchandise voyage à ses risques et périls, la responsabilité de l'assurance incombe au Client. CTESI décline toute responsabilité en cas de dommage, perte ou vol.

Toutes les pièces envoyées pour retour doivent être correctement emballées et protégées, de préférence dans leur emballage d'origine, contre tout dommage pouvant survenir lors du transport, et accompagnées des manuels, accessoires et/ou logiciels, le cas échéant.

garantias | garantías | Warranties | Garanties

Os produtos apresentados nos nossos catálogos têm uma garantia de 3 anos, a partir da data da fatura. Com exceção dos seguintes produtos: Autoclismos interiores – 10 anos e Torneiras – 5 anos, não sendo abrangidos os modelos com acabamento em cor, bem como os modelos termostáticos, eletrónicos e os complementos de torneiras (chuveiros, rampas, colunas de duche, bichas flexíveis, etc.) que têm os 3 anos. Móveis de casa de banho e Cabines de Duche também garantia de 5 anos.

Para efeitos de não aplicação da referida Garantia, informam-se os casos em que a mesma não é considerada:

- Produtos em que tenham sido introduzidas modificações pelo Cliente;
- Situações decorrentes de utilização negligente;
- Instalação incorreta;
- Manutenção deficiente ou motivo de causa maior;
- Produtos fornecidos por terceiros não incorporados em produtos fornecidos pela CTESI.

As garantias incluem a total ou parcial substituição do produto em caso de avaria, desde que esta seja devido a defeito de fabrico. Para efeitos de aplicação da garantia é necessário a aceitação do defeito do produto por parte do nosso Serviço Pós-Venda.

Qualquer pedido de substituição de peças durante a garantia, deverá obrigatoriamente ter a apresentação da fatura original e devolução da peça original, acompanhada pelo certificado enviado com o produto devidamente preenchido, caso contrário considera-se excluída a possibilidade de reparação e/ou reposição da mesma. As garantias excluem da nossa responsabilidade de fabricante, os custos de novas instalações bem como a substituição de peças por desgaste rápido.

Los productos presentados en nuestros catálogos tienen una garantía de 3 años a partir de la fecha de la factura, con excepción de los siguientes productos: Cisternas empotradas – 10 años; Grifos – 5 años, sin incluir modelos con acabado de color, así como modelos termostáticos, electrónicos y accesorios de grifería (duchas, barras, columnas, flexibles de ducha, etc.), que tienen 3 años de garantía.

Para la Garantía no se consideran las siguientes situaciones:

- Productos en los que el Cliente haya realizado cambios y situaciones resultantes de un uso negligente, de un mantenimiento o instalación incorrectos u otro motivo fortuito.
- Productos que no formen parte del artículo principal proporcionado por CTESI y que hayan sido suministrados por terceros.

Las garantías incluyen la sustitución total o parcial del producto en caso de que este presente un funcionamiento incorrecto, siempre que sea resultante de un defecto de fabricación. Para ello, es necesario que nuestro Servicio Postventa lo evalúe y lo apruebe. Cualquier pedido de reparación o reemplazo durante la garantía deberá cumplir con los siguientes puntos: presentar la factura original y devolver el artículo original, acompañado del certificado que ha sido enviado con el producto, debidamente llenado. De lo contrario, se excluye la posibilidad de repararlo y/o reemplazarlo.

The products presented in our catalogs have a 3-year warranty from the invoice date.

Exceptions are as follows: Internal cistern mechanisms – 10 years and taps – 5 years, excluding models with colored finishes, as well as thermostatic, electronic models and tap accessories (showers, rails, shower columns, flexible hoses, etc.) which have a 3-year warranty.

Bathroom furniture and shower cabins have a 5-year warranty.

For warranty exclusion purposes, the following cases are considered:

- Products modified by the Customer;
- Negligent use;
- Incorrect installation;
- Poor maintenance or force majeure;
- Products supplied by third parties not incorporated in CTESI products.

Warranties include total or partial replacement of the product in case of failure, provided it is due to manufacturing defects. Warranty application requires acceptance of the defect by our After-Sale Service. Any request for replacement of parts during the warranty period must be accompanied by the original invoice and the return of the original part, along with the certificate sent with the product duly completed; otherwise, repair or replacement is excluded.

Warranties exclude the manufacturer's responsibility for new installation costs and replacement of parts due to normal wear and tear.

Les produits présentés dans nos catalogues bénéficient d'une garantie de 3 ans à compter de la date de la facture, à l'exception des produits suivants : réservoirs encastrés – 10 ans ; robinets – 5 ans, sans inclure les modèles avec finition en couleur, ainsi que les modèles thermostatiques, électroniques et accessoires de robinetterie (douches, barres, colonnes, flexibles de douche, etc.), qui bénéficient d'une garantie de 3 ans. Pour la garantie, ne sont pas considérées les situations suivantes : produits modifiés par le Client, situations résultant d'une utilisation négligente, d'un entretien ou d'une installation incorrecte, ou d'une cause fortuite, ainsi que produits ne faisant pas partie de l'article principal fourni par CTESI et fournis par des tiers. Les garanties comprennent le remplacement total ou partiel du produit en cas de mauvais fonctionnement, à condition que cela soit dû à un défaut de fabrication. Pour cela, l'évaluation et l'approbation de notre Service Après-Vente sont nécessaires. Toute demande de réparation ou de remplacement durant la période de garantie doit respecter les conditions suivantes : présentation de la facture originale et retour de l'article original accompagné du certificat envoyé avec le produit, dûment rempli ; sinon, la réparation et/ou le remplacement seront exclus.

jurisdição | Jurisdiction | jurisdicción | Juridiction

Em caso de litígio com a CTESI, o foro competente é o da Comarca das Caldas da Rainha.

No caso de as condições acima estabelecidas não serem cumpridas, a CTESI reserva o direito de tomar as medidas convenientes. As presentes condições entram em vigor a de 01 de março de 2024 e prevalecem sobre quaisquer condições gerais do Cliente, anulando e substituindo as que anteriormente vigoravam. Este documento poderá ser alterado sem aviso prévio.

In the event of a dispute with CTESI, the competent court shall be that of the Caldas da Rainha District. If the above conditions are not met, CTESI reserves the right to take appropriate measures. These conditions come into effect as of March 1, 2024, and prevail over any general conditions of the Customer, canceling and replacing those previously in force. This document may be amended without prior notice.

En caso de litígio con CTESI, la jurisdicción competente es la del distrito de Caldas da Rainha.

En caso de que las condiciones anteriores no se cumplan, CTESI se reserva el derecho a tomar las medidas que considerar adecuadas. Las condiciones mencionadas entran en vigor el 1 de marzo de 2024 y prevalecen sobre las condiciones generales del Cliente, cancelando y sustituyendo las anteriores. Este documento puede sufrir cambios sin aviso previo.

En cas de litige avec CTESI, le tribunal compétent est celui de la juridiction des Caldas da Rainha. Si les conditions ci-dessus ne sont pas respectées, CTESI se réserve le droit de prendre les mesures appropriées. Les présentes conditions entrent en vigueur à compter du 1er mars 2024 et prévalent sur toutes conditions générales du Client, annulant et remplaçant celles précédemment en vigueur. Ce document peut être modifié sans préavis.







